



DISASTER MANAGEMENT PLAN 2020-2021



MALDA DISTRICT

*Sri Rajarshri Mitra,
I.A.S.*

*District Magistrate & Collector
Malda (W.B)
Telephone : Office : 03512-252381
Resi : 03512-252415
Fax : 03512-253092
Email : dm-malda@nic.in*

FOREWORD

The area enclosed by the district of Malda has historically been affected by the changing course of the rivers, even as its rise was due to being a major riverine port in the first place. Disturbances in the course of Ganga resulted in shifting of capital of the entire Bengal from Gaur (Lakhnauti) to Pandua in 1342 and again from there in mid-15th century when river Mahananda started to veer away from this site. The rivers have given this land fertility and also cursed it by frequent flood and erosion. The unique geological features of this district make it particularly vulnerable. Major part of the district except the eastern blocks covers an adjacent tract of flat lowland between 27 m and 21 m contours sloping gradually from north to south, and is classified into two additional physiographic regions viz the Tal and the Diara. Topographic gradients along the Tal region, consisting of the area defined by Chanchal Sub-Division, are barely existent, at an average of a mere 0.05 degree. Therefore, Ganga is the only fast moving river in this region, with a average gradient of 1:14500. The other minor regional rivers of the Tal barely manage to crawl across the tract at extremely low gradients ranging between 1:21000 and 1:25000 for Mahananda, Tangan and Punarbhava and even lower at 1:31200 for Kalindri. Because of this combination of low gradients and the resulting sluggishness in their water flow, all local rivers are prone to inundate the Tal during the monsoon, and the Mahananda with its large upstream catchment has often wreaked flood havoc in the tal tract. The situation faced in august last year was no exception to this. It was caused by some unscrupulous cutting of river embankment in neighbouring state, but the resulting flow of the water was too heavy to be carried away by the flat channels of the rivers and so inundated rapidly the catchment areas and beyond.

Embankments along the course of the rivers in the district have been heavily protected in the last few years. Irrigation department has been maintaining the major embankments and Gram Panchayats have also taken up similar works on a smaller scale, mostly utilizing resources from MGNREGS, thereby generating rural employment and at the same time creating valuable permanent flood protection assets. However, the topographical constraints causing water logging is a more difficult problem to handle. We need to think about overcoming this in innovative ways. Tal are is mostly composed of bog lands formed in many marshy packets around vestigial inland drainages. The streams of this zone have switched over to new courses, leaving many dead or dying channels that retain a trickle of water flow only during monsoons. Consequently, the Tal is strewn with marshes, small and big water bodies and oxbow lakes. Inter-braided streams with multiple channels also occur quite commonly along the rivers of this region displaying an amazing capacity to meander. We needs to rejuvenate these water bodies and marshy mudbanks of steams, channels and even rivers to increase their depth and carrying capacity. This requires considerable planning with respect.

To the contour mapping of the entire area in keeping with the overall north to south slope as was visible during the last flood. As a first step, we have completed the task of geo-referencing all of them with their local names so that seamless knowledge sharing between our machinery and the local people's wisdom can be utilized for optimal planning and execution. MGNREGS team of the district, block and Gram Panchayats has gone into mission mode to ensure permanent assets are created in the nature of increased water retention and carrying capacity and at the same time generating work at the villages.

This activity will help the water-scarce Baring region of Gazole, Bamongola, Habibpur and Old Malda as well, by recharging the groundwater level, and also rejuvenating the natural water bodies formed in the ravine-like geological structures formed by the impervious clayey soil which generates monsoon runoff and little percolation.

However, apart from these long term measures, we have to keep preparing for managing flood with determination every year. We have to take some lessons from last year as to prepare better. Interaction with local people have revealed that the historically flood prone nature of this district had prompted many families to keep small boats at their disposal over several generations. However, over time, these resources have diminished in quantity and quality. Last year several types of boats in large numbers were received and used from many sources, most importantly speed boats of Civil Defence and Disaster Management departments. However, even then the supply was less than demand and planning including ready availability of contact numbers of boat operators and means to take them to desired location has proved to be inadequate. We have to be better prepared. ICDS centers and resources have proved to be life savers in many areas. They may be strengthened even more to deal with similar emergencies.

The challenge faced by the Diara region formed by the Kaliachak-I, II & III, Manikchak and Englishbazar blocks are however, different. Historically this region has borne the brunt of river course shifting and erosion the most and therefore the occupational patterns have changed permanently. The risk of losing land coupled with high cost of cultivation has pushed many people to being migrant workers. Many of them are seasonal migrants who go to work elsewhere during lean season and come back when cultivation (in large part, mango season) takes place. Irrigation department has been fighting a difficult battle to save the vulnerable locations like Parlalpur in Kaliachak-III and Bhutni in Manikchak from consistent erosion pressure. Huge depth of Ganga has caused bed erosion which has proved to be difficult to manage even with large protection measures using boulder pitching and porcupine cage. Local GPs have also pitched in with support from MGNREGS. As the local people say, in Malda erosion starts as flood recedes, thereby making disaster management in this district a unique challenge.

Malda is flood prone District in West Bengal, the Ganga river flows along the western border of Malda, Fulahar, Mahananda and Behula river also flows over the District, which comes huge destruction by flood in Monsoon. To overcome this situation. We have to be vigilant to deal with excess rainfall and flood like situations. At the same time other disasters like thunderstorms fire etc. have to be properly protected against. Our two municipalities are also flood prone. Mahananda levels rose to much above EDL and stayed there for several days last year, posing grave challenges before both the municipalities. We have to clear our drainage system, check for small holes in our embankments where breaching takes place and keep in place proper system of reaching out to marooned families with food, water and other essentials and keep reviewing them from time to time so that we are never taken off guard by the forces of nature. We may not be a match to them, but we should never be caught napping.

(Sri Rajarshri Mitra, IAS.)
District Magistrate & Collector,
Malda.

Content

Sl. No.	Items	Page No
1.	Map with LACs, Blocks, GPs and villages of Malda District	02
2.	Roads Map of Malda District	03
3.	Map of Vulnerability Area of Malda District	04
4.	Maps of Important Rivers	05
5.	Brief History of Flood in Malda	06-07
6.	Scenario of past floods in Malda	08
7.	District profile	09-16
8.	Comparative figures of water level	17
9.	Block wise vulnerable area of Malda District	18
10.	District level food contingency Plan	19-20
11.	Important telephone Nos of Malda District	21-25
12.	Identified Helipads/high grounds in Malda district	25-26
13.	Contact Nos of Trucks owner/Abbulance/petro pump	27-30
14.	Contact Nos of Local venders of Food Supplies	31
15.	Some Do's and Don't during Natural Calamity	32 to 34
16.	Contact Nos of Pradhan and UPA Pradhan of Malda District	35-39
17.	Block wise owner of country Boat and contact Nos.	40-45
18.	Details of Heritage buildings or Sites in Malda District	46

Plans of Blocks & Municipalities

19.	Contingency Plan of Harischandrapur-I Development Block	47-50
20.	Contingency Plan of Harischandrapur-II Development Block	51-52
21.	Contingency Plan of Chanchal-I Development Block	53-60
22.	Contingency Plan of Chanchal-II Development Block	61-62
23.	Contingency Plan of Ratua-I Development Block	63-73
24.	Contingency Plan of Ratua-II Development Block	74-85
25.	Contingency Plan of Bamongola Development Block	86-96
26.	Contingency Plan of Habibpur Development Block	97-99
27.	Contingency Plan of Kaliachak-I Development Block	100-105
28.	Contingency Plan of Kaliachak-II Development Block	106-114
29.	Contingency Plan of Kaliachak-III Development	115-119
30.	Contingency Plan of Englishbazar Development Block	120-138
31.	Contingency Plan of Old Malda Development Block	139-146
32.	Contingency Plan of Gazole Development Block	147-165
33.	Contingency Plan of Manikchak Development Block	166-170
34.	Contingency Plan of Englishbazar Municipality	171-177
35.	Contingency Plan of Old Malda Municipality	178-180

Plans of Line Departments

36.	Contingency Plan of SP, Malda	181-193
37.	Contingency Plan of Health Department, Malda	194-198
38.	Contingency Plan of DI School, Malda	199
39.	Contingency Plan of Sericulture, Malda	200-201
40.	Contingency Plan of Horticulture, Malda	202
41.	Contingency Plan of Agri-Mech, Malda	203-204
42.	Contingency Plan of Mahananda Embankment, Malda	205-207
43.	Contingency Plan of Food Department, Malda	208
44.	Contingency Plan of WBSEDC (South), Malda	209-217
45.	Contingency Plan of Irrigation, Malda	218-224
46.	Contingency Plan PHE, Malda	225
47.	Contingency Plan of Civil Defence, Malda	226-233
48.	Contingency Plan of Malda Highway Division, Malda.	234-236
49.	Contingency Plan of Fire Station, Malda.	237

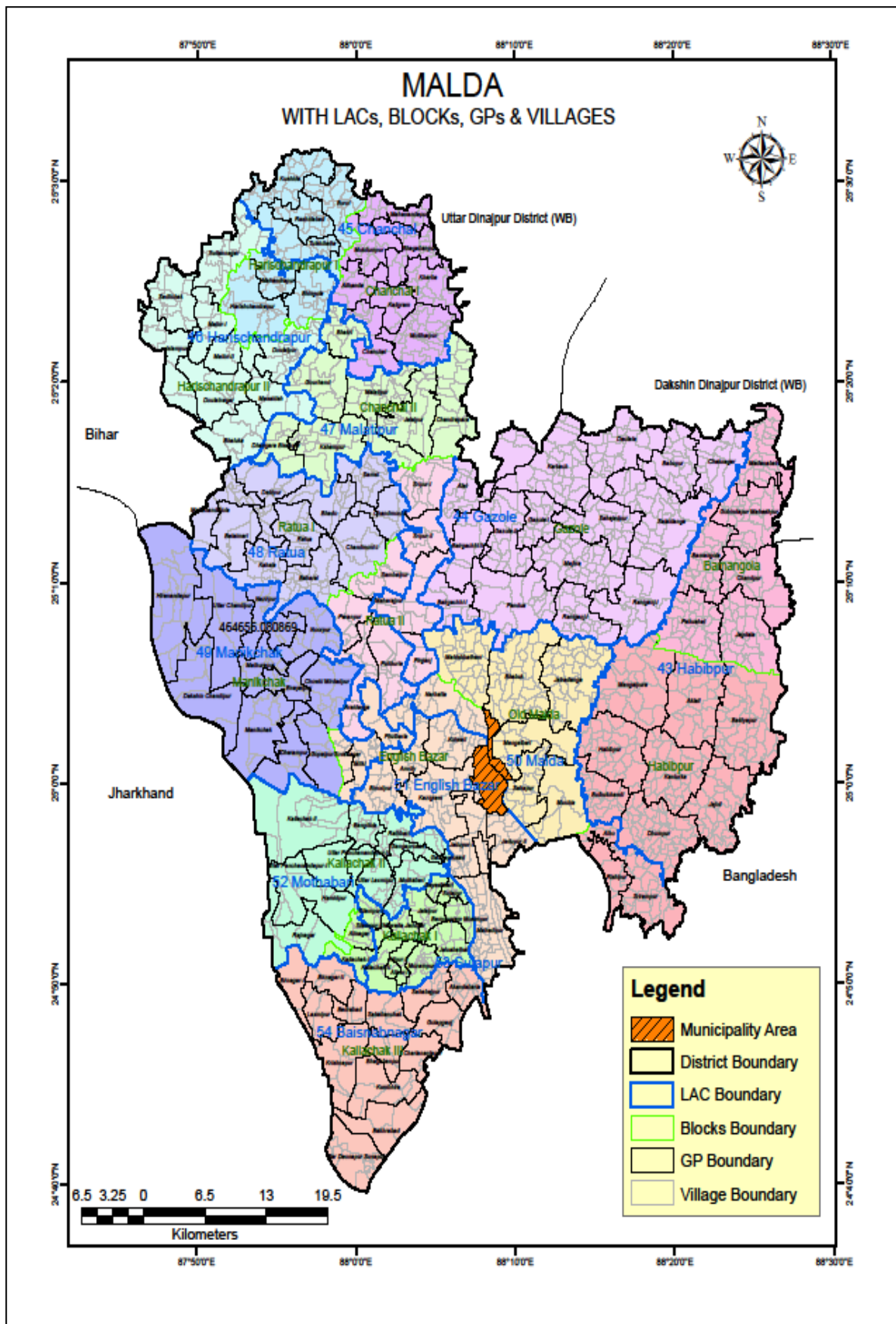

VULNERABILITY MAP

MALDA DISTRICT
WEST BENGAL

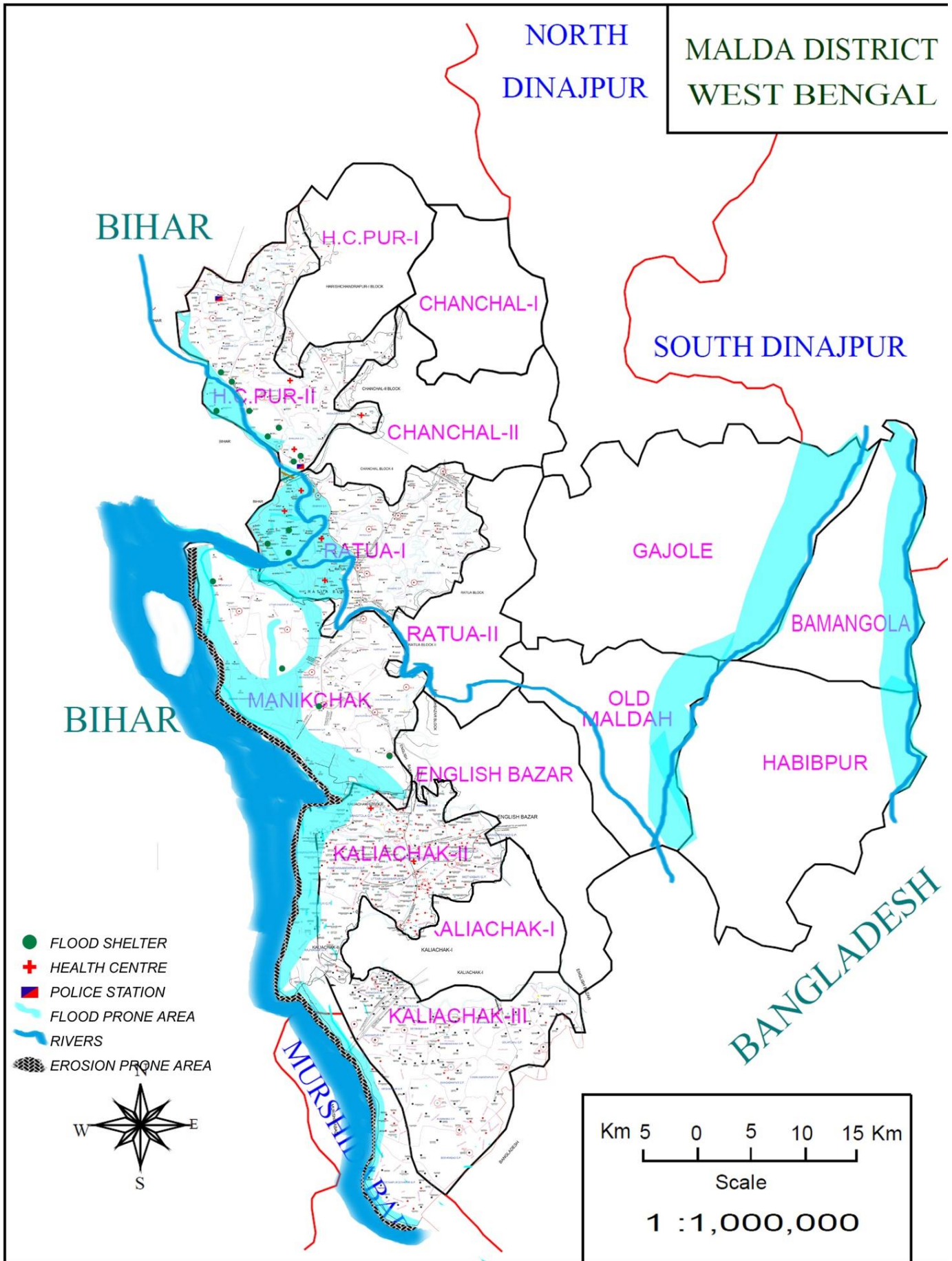

- FLOOD SHELTER
- + HEALTH CENTRE
- POLICE STATION
- FLOOD PRONE AREA
- RIVERS
- EROSION PRONE AREA

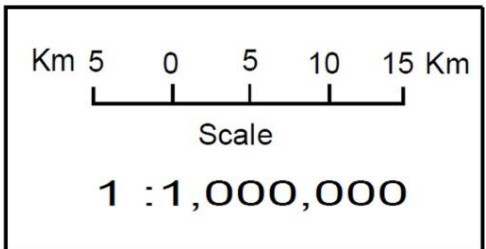

Map of Important Rivers

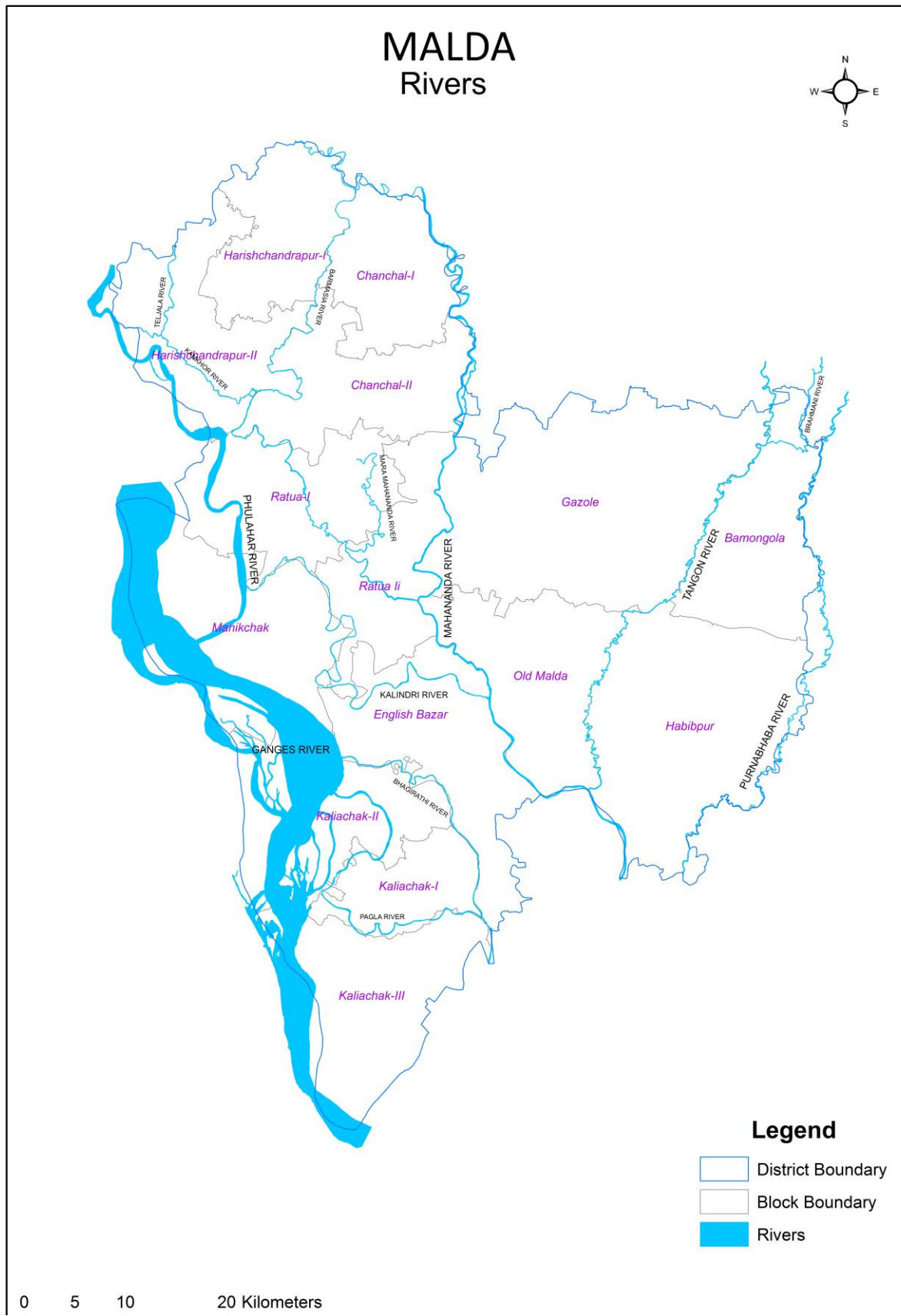

A BRIEF HISTORY OF FLOODS IN MALDA

Floods of destructive character are of frequent occurrence in Malda. Between 1850 and 1870, there occurred three several inundation, which caused great distress in all parts of the district especially in the low lands along the rivers. After 1870, the years of high flood were 1875, 1885, 1906, Floods also affected the district in the years 1918, 1922, 1935 and 1948. In the recent past, severe inundation was experienced in the years 1987, 1988, 1991, 1995, 1998, 2017 and 2019.

These floods resulted not so much from rain in the District but due to overflow of water in the rivers caused by rainfall in the upper catchments areas. Most of the rivers and streams in Malda, the most important of which is the Ganges take their rise in the Himalayan mountains and are therefore, susceptible to sudden inflow of huge water caused by the melting of snow or by excessive rainfall in the mountains.

Successive heavy rainfall for three days in 1995 caused serious water logging and flash floods in Malda Town due to inadequate drainage system. In the years 1996, part of Malda district experienced a record 40 days continuous flood due to heavy rains in upper catchments areas of the river Ganges. The loss of lives and damages of properties caused by the flood was also considerable.

In the first phase, erosion of newly constructed 5th embankment started at Gopalpur in Manikchak Block on 04.07.1998. Huge river water flushed into country side affecting huge area of Gopalpur G.P. of Manikchak Block and K.B. Jhoubona G.P. of Kaliachak-II Block. In the 2nd phase, flood water spread into more Block areas between 30.07.1998 & 07.08.1998.

Fresh flood occurred in the third phase due to heavy rainfall in the district and upper catchment areas and flood water affected all the Blocks and the Municipalities. Rise of water level of different rivers namely Ganga, Fulahar and Mahananda caused unprecedented devastation in the district. This flood inundated almost the entire area of the district and caused dislocation of traffic and unanticipated damage of Govt. as well as private properties. This calamity has taken a lot of human and cattle lives. The depth of the flowing flood water varied from 4 feet to 10 feet in various parts of the district.

District administrative machinery along with the line departments of the District was engaged in relief and rescue works on war footing with the help of Army.

The National Highway, the State Highway and other roads of the district were sub-merged in many places resulting in disruption of communication.

Flood of 1999 inundated northern parts of the district. Some blocks in the southern parts of the district had also been severely affected. The National Highway, Gazole-Alal Road, Kotowali-Puhuria more and Manikchak-Ratua road were submerged and damaged in some places causing disruption of communication, particularly with the northern parts of the district. Due to disruption of road communication, relief materials had to be dispatched through Railway Services.

Many voluntary organisations like R.K. Mission, Bharat Sevashram Sangha, Kashi Biswanath Seba Samity, Red Cross Society, Lutheran World Service, Lions Club, Bharat Scouts & Guide, CARE, etc. rendered services in flood affected areas.

Flood situation in the year, 2003 was not so grim in comparison to that of 1999, but the menace of erosion played havoc. The advancement of the Ganges and Fulhar went apace for the past few years playing mockery with whatever attempts put to effect to check the onslaught of erosion. The spurs and embankments erected to curb the rate of erosion had been failed continuously. Placement of porcupines and bolder-pitching on river embankments to some extent could show a little in the face of great threat.

Flood occurred in the second phase due to heavy rainfall in the district and upper catchment areas. Rise in water level of different rivers, namely Ganga, Fulhar and Mahananda caused inundation of several areas of Malda district. Erosion and flood went hand in glove to wreck devastation in the district. Almost 236 Nos. of villages with nearly 1.64 lakh population were severely affected. Approximately 5043 hec. Of cropped area affected.

The administrative machinery along with different departments of the district rose to the occasion in relief and rescue work on war footing. Many voluntary organisations rendered commendable service in flood affected areas. Strict vigil was maintained to oversee the situation through liaison officers and Flood Co-ordination Committee meetings were held daily. Need based sub-allotments of relief materials, sinking of tube wells and deployment of medical teams at the affected areas were made. All out efforts were made to save electric power supply stations.

The district is fortunate enough to have a respite from the menace of flood and Erosion during 2005, 2006, 2007 & 2008 in a row. During 2006 heavy & incessant rainfall from 21.09.2006 to 25.09.2006 has created a flood like situation in almost all blocks under this district. During 2007 a vast part of Harishchandrapur-II & Ratua-I blocks were inundated due to sudden erosion of Bhaluka embankment at Harishchandrapur-II block. This district experienced devastating flood in the last year mainly due to breach of bundh over Fulohar at Dhabol in Bihar and sudden flush of flood water combined with incessant rain for three to four days from 12th August 2017 engulfed almost the whole district. The Chanchal sub division and Gazole, Bamongola, Habibpur, Old Malda and Englishbazar blocks were the worst affected. The span of flood was more than 20 days causing a havoc to the lives and property of our district. The District Administration with the help of various line deptt rose to occasion to restore normalcy. The threat of flood and erosion still hang over the district this year also. With the forecasted arrival of monsoon, the countdown already has started this year also.

Pictures of past Flood



REDMI NOTE 5 PRO
MI DUAL CAMERA



নদী-পরিবহণে লাইফ জ্যাকেট আবশ্যিক করল জেলা প্রশাসন

রঞ্জুগোপাল মুখোপাধ্যায় • মালদহ

বিএনএ: চাঁচলের নৌকোভূমি থেকে শিক্ষা নিয়ে মালদহে ফেরি চলাচলে একগুচ্ছ পদক্ষেপ নিতে চলেছে জেলা প্রশাসন। নৌকার যাত্রীদের 'লাইফ জ্যাকেট' পরা বাধ্যতামূলক করতে চলেছে প্রশাসন। ইতিমধ্যে রাতে নদীতে নৌকো চলাচলের উপর সম্পূর্ণ নিষেধাজ্ঞা জারি করা হয়েছে। জেলা প্রশাসন সূত্রে জানা গিয়েছে, তিনজেলা ও অন্য রাজ্যের সঙ্গেও নদীপথে মালদহের যোগাযোগ রয়েছে। জেলায় বর্তমানে ১৬০টি নদীঘাটে খোয়া পারাপার হয়। অর্ধচ মাত্র ১০০টি নদীঘাটে নৌকো চলাচলের অনুমতি রয়েছে। বাকিগুলিতে বৈধভাবে ডাক হয় না। চাঁচলের ঘটনার পর বিষয়টি নিয়ে প্রশাসন কড়া পদক্ষেপ নিতে চলেছে। জেলায় অবৈধঘাট রাখা যাবে না। দ্রুত সেগুলিকে জেলা পরিষদ বা পঞ্চায়েত সমিতির আওতায় আনা হবে। ছোট ঘাটগুলিকে গ্রাম পঞ্চায়েতের আওতায় আনা হবে।

মালদহের জেলাশাসক কৌশিক ভট্টাচার্য বলেন, আমরা খোয়া পারাপারের ব্যাপারে বেশকিছু পদক্ষেপ করছি। নৌকায় ওঠা সবযাত্রীকে লাইফ জ্যাকেট পরাতে হবে। পঞ্চায়েত সমিতি বা জেলা পরিষদের তরফ থেকে ঘাটগুলিতে ওই জ্যাকেট সরবরাহ করার বিষয়টি খতিয়ে দেখা হচ্ছে। সূর্য অস্ত যাওয়ার পর নদীতে যাত্রীবোঝাই নৌকো চলাচলের উপর নিষেধাজ্ঞা জারি করা হয়েছে। বহন ক্ষমতার অতিরিক্ত যাত্রী কোনওভাবেই নৌকায় চাপানো যাবে না। যাত্রীদের সচেতন করার জন্য অনবরত মাইকে বিষয়টি ঘোষণা করা হবে। কৃষি নিয়ে নৌকায় যাত্রী না চাপানোর ব্যাপারে মাঝিদেরও সচেতন করা হবে। যাত্রীদের জন্য টিকিটের ব্যবস্থা করতে হবে। এতে নৌকায় যাত্রী পরিবহণের উপর নিয়ন্ত্রণ রাখা সম্ভব হবে।



এছাড়া নজরদারির জন্য বর্নির্ভর গোষ্ঠীর মহিলাদের ঘাটে মোতায়েন করা হবে। ঘাটের নিলাম থেকে পাওয়া টাকার তাদের সাম্প্রতিক দেওয়া হবে। নিলামে নেওয়া ঘাটের মালিক ও তাঁর অন্তত তিনজন সহকারীকে পরিচয়পত্র দেওয়া হবে। তাদের যে কোনও একজনকে যাত্রী পরিবহণের সময় ঘাটে উপস্থিত থাকতে হবে। এর অন্যথা হলে ঘাটের নিলাম বাতিলের মতো কড়া সিদ্ধান্ত নিতে প্রশাসন বাধ্য হবে। আমরা যাত্রী নিরাপত্তার ব্যাপারে কোনওভাবেই আপস করব না।

উল্লেখ্য, পুজোর আগে চাঁচলের জগন্নাথপুর ঘাট থেকে প্রায় ৪৫ জন যাত্রী ও ছয়টি বাইক ও সাইকেল নিয়ে একটি নৌকো ইটাহাদের হুন্সদপুর ঘাটে আছিল। মাঝে নৌকোটি বিহারের আশাবন্দুর থানার একটি ঘাটে যাত্রী ওঠা-নামা করার। রাত ৮টা নাগাদ হুটাছারমুখী নৌকোটি মহানন্দা নদীতে উল্টে যায়। নয় জনের মৃত্যু হয়।

বাকিরা সাঁতরে পাড়ে উঠতে সক্ষম হয়। এই ঘটনার পরই জেলা প্রশাসন নড়েচড়ে বসে। যাত্রীদের অভিজোগ ফেরিঘাটের উপর নজরদারির কোনও ব্যবস্থা নেই।

মাঝিরা অতিরিক্ত মুনাহার জন্য বেশিমাত্রায় যাত্রী তোলে। এতে কৃষি থেকেই যায়। মাঝেমধ্যেই ছোটঘাট

দুর্ঘটনা ঘটে।

প্রশাসনের এক আধিকারিক বলেন, ইতিমধ্যেই বিভিন্নদের সব ঘাট পরিদর্শন করে তথ্য দেওয়ার জন্য নির্দেশ দেওয়া হয়েছে। ব্রহ্ম প্রশাসনের আধিকারিকদের সরঞ্জামের পরিস্থিতি খতিয়ে দেখে নিশ্চিত রিপোর্ট তৈরি করতে হবে। ঘাটগুলির নিরাপত্তা খতিয়ে দেখার জন্য আমরা ওই রিপোর্ট নিয়ে জেলা স্তরে আলোচনা করব। যাত্রীদের জীবন নিয়ে ঝিনিমিনি খেলা বরদাশ করা হবে না। কেউ এব্যাপারে অবহেলা করলে আইনানুগ ব্যবস্থা নেওয়া হবে।

District Profile

1.	Geographical Area	3733 Sq Kms (As per Census 2011)					
2.	Geographical Location	24°40'20"N to 25°32' 08"N 87°45'50" E to 88°28'10" E.					
3.	No. of Subdivisions	2					
4.	No. Of Police Stations	11 { Out Post – 13 (as in '99)}					
5.	No. of Municipalities	2					
6.	No. of Blocks/Panchayat Samitis	15					
7.	No. of Gram Panchayats	146					
8.	No. of Gram Sansads	2008					
9.	No. of Mouzas	1814					
10.	No. of Villages	3701					
11.	Population (Census 2011)	Male		Female		Total	
	RURAL	1,768,336		1,678,849		3,447,185	
	URBAN	283,205		258,455		541,660	
	Total Population of the District	2,051,541		1,937,304		3,988,845	
	Rural (0-6 Yrs.)	270,666		259,960		530,626	
	Urban (0-6 Yrs.)	41,674		36,740		78,414	
	Total (0-6 Yrs.)	312,340		296,700		609,040	
	Rural Literate	961,409		770,268		1,731,677	
	Urban Literate	190,610		164,145		354,755	
	Total Literate	1,152,019		934,413		2,086,432	
Population as per Religion (2001 Census)	Hindu	Muslim	Sikh	Buddhist	Jain	Others & Christian	

		1621468	1636171	283	164	293	22350 &
							8388
	SC Population (2011 census)	835,430					
	ST Population (2011 census)	313,984					
	Total Main workers	1,050,995					
	Total Cultivators	219241					
	Total Agri Labourers	322452					
	Total Population in household industry	98383					
	Other workers	410919					
	Marginal Workers	486852					
	Non-workers	2450998					
12.	General Education (2012)						
	No. of Primary Schools:	1888					
	No. of Middle/Junior H. School	112 (Including New Setup 105)					
	No. of Secondary Schools	137					
	No. of Higher Secondary/Multipurpose Schools:	119					
	No of MadrashahSchool:	12					
	No of JuniorMadrashahSchool:	19					
	No of HighMadrashahSchool:	38					
	No of New SetupMadrashahSchool:	8					
	No. of Colleges	8					

13.	Professional & Technical Education: (2012)	
	Engineering & Technical School (Govt)	3
	No of Engineering Collage (Private)	1
	No of Vocational Training Centre (VTC) at different Schools:	145
	College: Teachers' Training (Govt)	1 (B.ED) 1 (PTTI)
	No of Private B.ED	5
	No of Private D.ED	5
	No of Central School	1
14.	Special Education (2012)	
	Baisc Literacy Centre	25112
	Lok Siksha Kendra	146
	No of MSK	108
	No of Sishu Siksha Kendra(SSK)	618
15.	Libraries Reading Rooms and TLCs(2012)	
	Public Library	105
	Free Reading room	108
	TLC	56260
16.	HEALTH &FW (2012)	
	Medical Collage	1
	District Hospital	1
	SubDivision Hospital	1
	Hospitals	11

	Health Centres	45
	Clinics	432
	Dispensaries	7
	BPHCs	10
	Rural Hospitals	5
	Primary Health Centres	35
	Sub Centres	511
	Total Beds	1259
	Family Welfare Centres	16 (15 Public; 1 Private)
	ICDS Projects	16 (15 Blocks , 1 Municipality)
	AWW Centres	5573
17.	No. of Cinema Houses (2012)	27
18.	AGRICULTURE & Allied (2012)	
	Normal Rainfall	1485.2 mm.
	Total Area.	373300 Hec
	Forest	1680 Hec. { Reserve- 806; Protected-378; Vested Waste Land - 509.80}
	Cultivable Area:	2,80,000 Hec.
	Net Cultivable Area:	2,59,921 Hec.
	Orchard and Horticultural Crops:	75000 Hec.
	Pasture and other grazing Land:	435 Hec.
	Gross Cropped Area:	4,74,701 Hec.
	Cropping Intensity:	196

Cultivable Waste Land:	671 Hec.
Marginal Holding (below 1.0 acre)	310706; Area-171105 Hec. (05-06)
Small Holding (1.0-2.0 acre)	49860; Area-81798 Hec. (05-06)
Medium Holding (2.0-4.0acre)	15012; Area-40121 Hec.
Medium Holding (4.0-10.0acre)	991; Area-4864 Hec.
Large Holding (10.0 acres and above)	01; Area-10 Hec. (05-06)
Vested Land Distributed(30-9-2002)	30332.00 Hec.; { SC-39310, ST-29168; Othrs.-82893}
Area Irrigated	120067 { HDTW – 6150, MDTW – 242, LDTW – 641, STW – 78.494 , RLI – 8600, Others Sources – 24627, Tank – 1308, Net Irrigated Area – 1,44,588 Hec., Land Under Non Agricultural Use – 87,940 Hec.}
Minor Irrigation	Tank – 254, HDTW – 326, MDTW – 18, LDTW – 108, STW – 33837, RLI – 384, ODW – NIL, Others - 445
Fertilizer Consumed	Nitrogen- 21910 Tones; Phosphorus- 14380 Tones; Potassium- 13430 Tones.
No. of Agri-Implement Hub	3 (Habibpur, Gazole, Chanchal-I)
LIVESTOCK (2012)	3892930 (All)
Veterinary Hospitals etc	SAHC-4, BAHC-15, ABAHC-15, ADAC- 146, AI Centres- 146 (Prani Bandhu) and 100 (Govt.)
19. Cooperative And Banking (2012):	
Central Banks	Societies- 1, Members- 690
Primary Land Mortgage Banks	Societies- 1, Members- 6199
Agricultural Societies	218, Members- 109252
Non Agri Credit Societies	Societies- 308, Members - 13594
All Credit Societies	Societies- 414, Members- 119086

	Non- Credit Societies	Societies- 112, Members- 3756
	Total No. of Credit and Non-Credit Societies	526, Members- 122846
	COMERCIAL BANKING	Rural- 134, Semi Urban- 19, Urban- 8, Total- 145{Ave. Population /Branch- 24600}
20.	INDUSTRY (2012)	
	Small Industry (Regd. Cottage & Small scale Industry)	2481, Employment-14857 (after implementation of MSMED act 2006)
21.	POWER	
	Total no. of villages electrified	1773
	Consumption of Electricity (in thousand KWH)	Domestic – 77560 Commercial – 13454 Industrial – 16199 Public Lighting – 598 Agri Irrigation & Dewatering – 31627 Public water works & Sewarage Pump – 4187 Total – 143625.
22.	No of Enterprises	
	Agri	Rural- 526 Urban – 15, Total – 541
	Non-Agri	Rural – 1881, Urban – 445, Total – 2326
23.	Regulated Market (2012)	Principal Market yard – 2, Sub Market yard – 17
24.	Market (all categories)	136
25.	Regional Research Station on Subtropical Fruits by ICAR (proposed)	1
26.	Jute purchasing center under JCI (2012)	5
27.	Govt. Farms (all categories)	9
28.	Cold Storage	5 (4 Multipurpose)

29.	MR Shop (2012)	762
30.	TRANSPORT & COMMUNICATION	
	Registered Motor Vehicles (as on 21/08/2012)	Heavy Goods vehicles – 3872 Medium Goods Vehicle – 336 Light Goods Vehicle – 2998 Three Wheeler Goods Vehicle - 96 Jeep Taxi – 756 L.M.V (Car) – 6391 L.M.V. (Van) – 86 L.M.V.(JEEP/GYPSY) – 162 Bus - 252 Mini bus – 2 Maxi Cab - 51 OMNI Bus – 409 Omni Bus (Private) - 1285 Tractor- 4646 Trailers –1725 Motor Cycle – 62970 Scooter - 2112 Ambulance - 116 Three Wheeler (Passenger) – 715.
	PWD	Surfaced – 677.50 km Un surfaced – 5.00km. Total – 682.50 km.
	Zilla Parishad/Panchayet	Surfaced – 579.50 km, Un surfaced – 269.50 km., Total – 849.00 KM
	Municipalities	247.85 km., Un surfaced – 240.74 km Total- 488.59 km
	Railway Station	12 (Main Stations)
31.	POST and Telegraph (2012)	
	Post Office	37 (Departmental), 296 (Branch Office)
	BSNL	Total 57 (Under Malda SDCA – 29, Bulbulchandi SDCA- 8, Chanchal SDCA – 19, and Malda Main - 1)

INTRODUCTION

Malda District is the gateway to North Bengal. This District comprises with 2 Sub-Divisions, 15 Blocks and 2 Municipalities under the administrative control of Malda Division.

GEOGRAPHICAL LOCATION

This District is bounded on the North by North Dinajpur District (West Bengal) and the District of Purina (Bihar). On the East, it is partly bounded by the District of South Dinajpur (West Bengal) and the District of Rajshahi (Bangladesh), on the South by Murshidabad (West Bengal) and the District of Santhal Parganas (Jharkhand).

River system

The rivers those traverse this district from north, north-west and north-east to the south are Ganga, Fulahar, Mahananda, Bhagirathi, Tangon, Kalindri, Punarbhaba and Pagla. The main river Ganga with its tributaries Fulahar, Bhagirathi and Kalindri enters this district at Gaduri of Bhutni Char of Manikchak block and flow over the block Manilchak, Kaliachak-II and Kaliachak-III. Flood frequently caused due to erosion and overflow of excessive rainfall of catchment areas.

River	Entry point	Runs through the blocks	Length in district	Tributaries	End point
Ganga	Gaduri of bhutni Char of Manikchak	Manikchak, Kaliachak-II & Kaliachak-III	172 kms	Fulohar, Bhagirathi and Kalindri	Pardeonapur (Kaliachak-III)
Mahananda	Junction of Chanchal-I, Ratua-II & Gazole	Gazole, Habibpur, Oldmalda & Englishbazar	886 kms	Kalindri Pagla	Aiho (Habibpur)
Punarbhaba	North-eastern part of Bamangola	Bamangola	64.4 kms	Haria	Eastern boarder of Bamangola
Tangon	Junction of Bamangola & Gazole	Bamangola, Oldmalda, Habibpur & Gazole	64.6 kms	Chunakhali Khal	Mahananda
Kalindri	Mianghat (Harishchandrapur-II)	H.C pur-II, Englishbazar, Manikchak & Ratua-I	Not available	Fulohar	Mahananda at Bachamari (Old Malda)

CLIMATE

The climate of the district is rather extremely very hot and sultry during summer season, with rains and moisture in the air throughout the year. Basically, there are four seasons in the year. The cold season start about the middle of November and continues till the end of February. The period from March to May is the summer season. The rainy season starts in June with the coming of South-West monsoons and continues till the middle of September. October and the first half of November constitutes the post monsoons season. The normal rainfall is 1485 mm. The maximum precipitation occurs during the period from June to September. The maximum rainfall recorded during the year 2019-20 was 1402 mm.

COMPARATIVE FIGURES OF WATER LEVEL

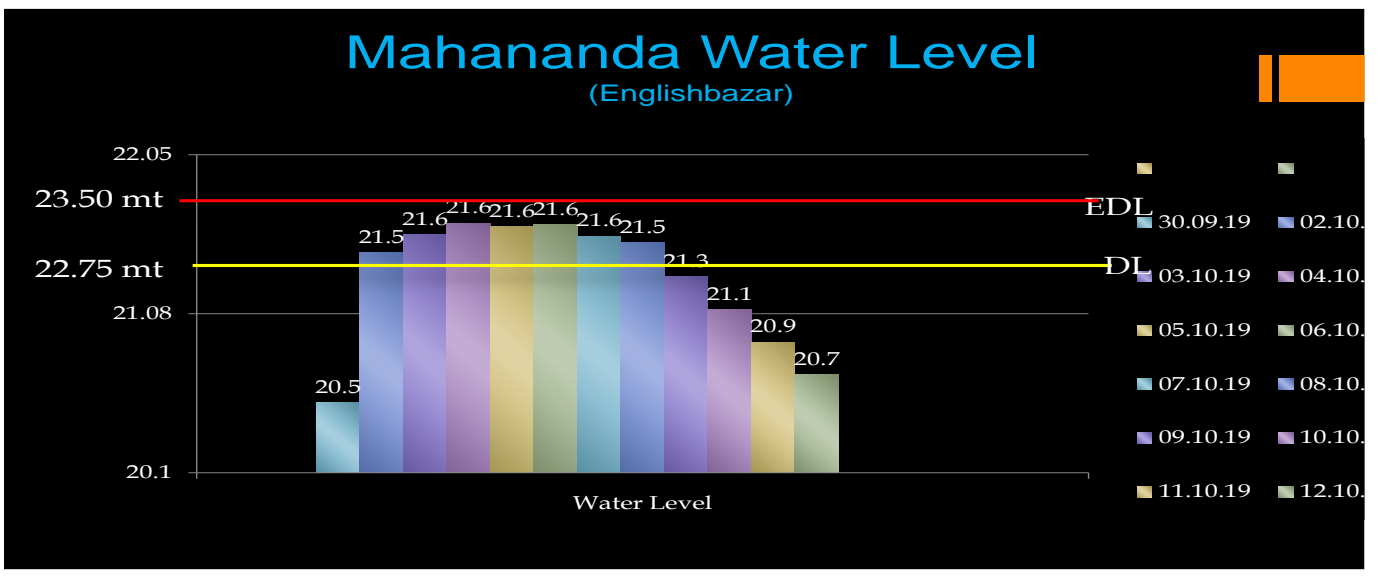
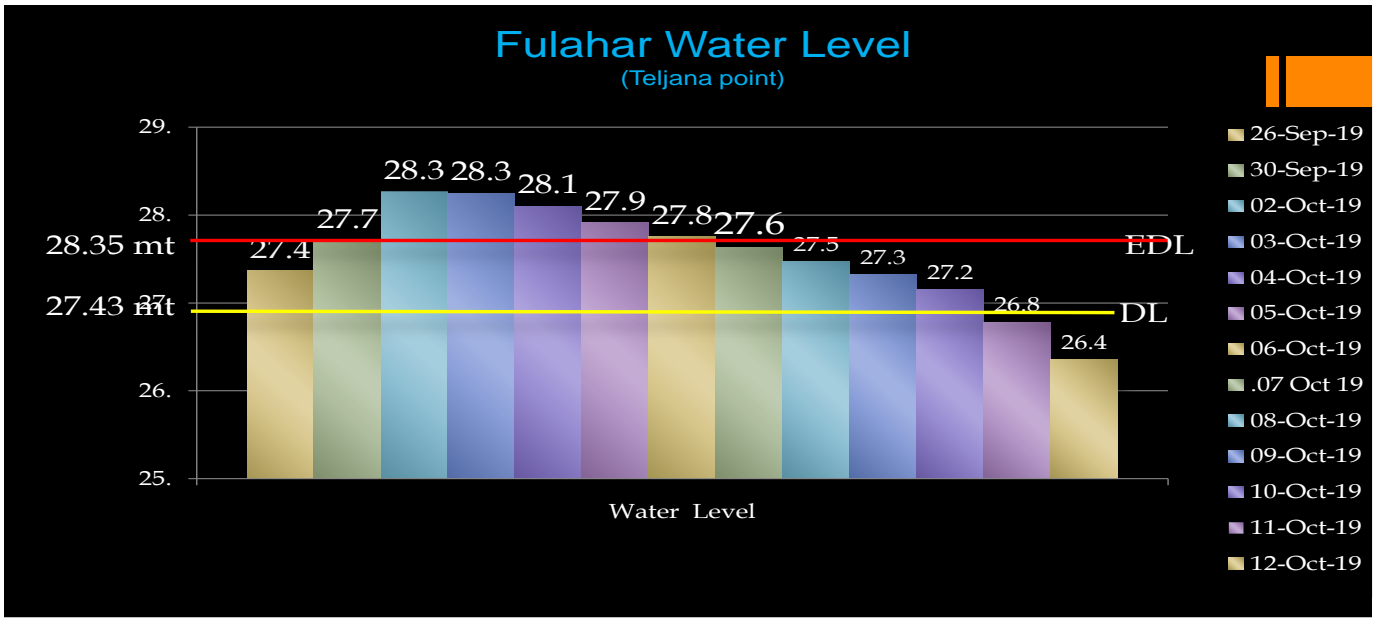
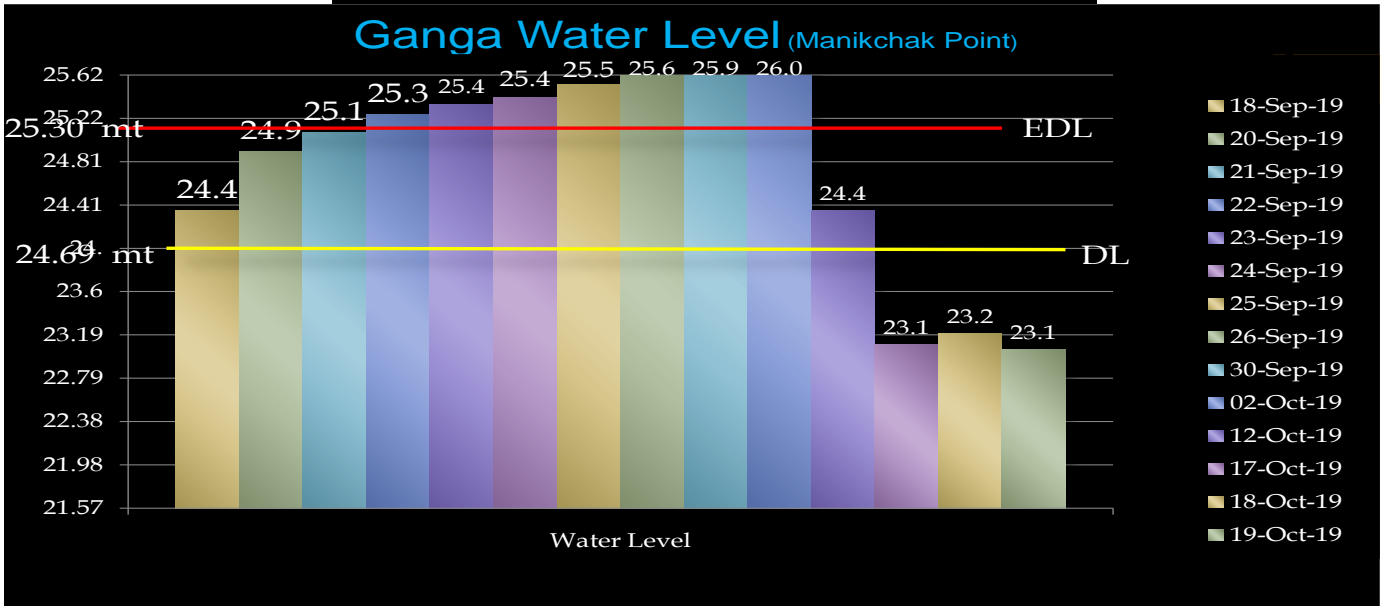

AREAS VULNERABLE IN RESPECT OF FLOOD

<i>Sl No</i>	<i>Name of Blocks</i>	<i>Name of the G.P.</i>	<i>G.P wise vulnerable villages</i>	<i>Adjoining rivers</i>
1.	H.C.Pur-II	Doulatnagar	Doulatnagar , Mihahat & Khidirpur	Mahananda & Fulhar
		Bhaluka	Hattichapa & Par Bhaluka.	
		Islampur	Basta,Imamnagar, Khopakathi, Islampur, Chandpur, Bhajana, Uttar Bhakuria & Dakhin Bhakuria	
2.	Ratua-I	Debipur	Debipur ,Terashia, Balupur & Durgapur.	Fulhar , Koshi & Kalindri
		Mahanandatola	Bankutola, Janjalitola, Bajitpur, Dharmatola, Badantola, Jagabandhutola, Sambalpur & Sudamtola.	
		Bilaimari	Ramayanpur,Ruhimari, Gangaramtola, Nakkati, Nayabilaimari, Dewanwala, Khasmahal & Ajjitola.	
		Kahala	Kalutola, Asutola, Suryapur, Kamalpur, Kahala, Haragobindapur & Narattampur.	
		Baharal	Nimtalli, Sahapur Uttar, Sahapur Dakshin & Baharal.	
3.	Manikchak	Gopalpur	Kamaltipur,Sahabattola(part),Balutola, Nasutola(part), Kalitola, Iswartola(part) & Elahitola(part).	Ganga & Fulhar
		Dharampur	Wahedmara, Barabagan(part) & Sonapur.	
		Manikchak	Ramnagar,Jotpatta,Rabidaspara,Sibantola,2No.Bridge para,Darbari tola, Narayanpur, Narayanpur Id gaha para, Manikchak ghat Bandh Para, Jalalpur (part), New sonapur, Mankud, Domhat, Chamatola. Madantola & Palpara.	
		Dakshin Chandipur	Mahendratola,Raghunath tola,Bhabani tola,Bipin tola, Durgaram tola,Payari tola, Panchu tola,Ratan tola, Duyani char,Bhojan tola,Jaipaltola, Sukdev tola, Bhim tola, Nayan tola,Lutihara, Debu tola, Krishnatola, Bhabanathola, Ganesh tola, Nabadiptola,Amintola & Pulintola bandh.	
		Hiranandapur	Gadai, Nanditola,Mathurtola,Bagdukra, Benutola colony, Kaluton tola,Rajkumar tola, Bagedantola, Piyaritola, Debutola, Anantalaltola,Giridharotola, Gourangatola ,Domontola, Lutihara, Baikunthatola & Chabiltola.	
		Nazirpur	Laksikol(part), Laskarpur(part), Haripur(part) & Jitmanpur(part).	
4.	Kaliachak-II	Bangitola	Jote kostuty, Mahadevpur, Bintola, Sadipur, Gosaihat & Chowdhutyola.	Ganga
		Uttar Panchanandapur-I	Dolboxtola, Ramlaltola(part), Loharditola, Sultantola, Laskaritola, Paglaghat Bus stand, Jinerditola & Nasarattola.	
		Uttar Panchanandapur-II	Dhelfora, Jitnagar & Jugaltola.	
		Hamidpur	Shibutola, Etwaritola, Shripur colony, Piaritola(east & west) Tofi, Mathabhanga, Jatintola, Chumkitola, Chechrutola, Khatiakhana char & 8 No.Spar bandh.	
		Rajnagar	Nayagram Model & Bromottar.	
5.	Kaliachak-III	Birnagar-II	Dinutola, Asgarhajitola	Ganga
		Laxmipur	Ajimtola, Atartola, Hajrattola, Bhangatol, Jagantpur, Mouza	
		Krishnapur	Mondai, Charsujapur, Surenmandalpara & Kalitola	
		Bakhrabad	Deonapur	
		Kumbhira	Noornagar & Sabdalpur	
		P/Sovapur	Parlalpur, Shibpur,Par anupnagar, Golapman & Dalpra	

DISTRICT LEVEL FLOOD CONTINGENCY PLAN

Pre-Flood arrangements:-

1. Holding meetings of District Block, Gram Panchayat and Gram Sansad level Disaster Management Committees and updating of contingency plan.
2. Functioning of Control room in collectorate as well as in the office of every GP blocks, line departments specially police, irrigation, Agriculture, Animal Resource, PHE ,PWD,Mahananda Embankment Division and Health Department.
3. Joint inspection of vulnerable embankments with irrigation officials, Repair of sluice gates flood protective embankments breaches and rain cuts. Installation of heavy duty pumps for pumping out of stagnant water from malda town.
4. Identification of vulnerable areas, vulnerable groups and people and mapping thereof Repair and maintenance of flood shelters.
5. Communication of river gauge readings of various rivers issued by flood forecasting cell malda and Central Water Commission. Patna to respective SDOs, BDOs and GPs.
6. Dissemination of rainfall, weather and flood reports received from government and IMD.
7. Installation of temporary Police RT sets at different vulnerable points in addition to eight irrigation TR sets.
8. Arrangements for storage of adequate relief materials in every block relief go-down stock of Sub-Division Officer, Chanchal is also to be enriched.
9. Rolling stock of Kerosene Oil to be maintained at MR Dealer, Big dealer and Agent level, Rolling stock of rice at the rice millers level and adequate stock in FCI Go-down.
10. Formation of rapid response teams in all level from out of ten DMT members and Civil Defence volunteers. Formation of medical RRT at each BPHC level to cope with medical exigency.
11. Boats, speedboats and other accessories to be kept ready. Preparation of list of boat owners and make it available with BDO and Gram Panchayat.
12. Keeping liaison with Army Officials tagged with the district.
13. Conduct of mock drill as many as possible.

Activities during flood:

1. Control room will function round the clock, RT Set, Telephone and Fax will be done in working Condition.
2. People will be made alert with study of gravity of situation and evacuation will be taken up to the people of high risk zone.
3. Boats and other conveyance will be deployed in strategic point.
4. Shelter Management with drinking water facility and sanitation arrangement will be ensured.
5. Necessary steps are being taken up for sinking and re-sinking of tube-wells and setting up of latrine is being ensured through total sanitation programme in the identified flood shelter.
6. Health system development scheme have been taken up for better health service to the vulnerable people. NGOs to be mobilised to this work also.
7. Co-ordination meeting with deferent line department for taking follow up Rescue, Relief and Rehabilitation Programme and to analysis the problem and action taking decision.
8. Post disaster arrangement will be done providing financial assistance for rebuilding of damage houses, restoration of rural assets and alternative crop cultivation bank of other financial institution will be mobilised for this purpose.

3. Important Telephone Numbers :

SL NO.	LIST OF OFFICIALS OF THE DISTRICT ADMINISTRATION	CONTACT NO.	REMARKS
1	DISTRICT MAGISTRATE, MALDA	7719360700/03512-252381,253030	
2	ADDITIONAL DISTRICT MAGISTRATE(GENL.), MALDA.	7719360701/03512-252351	
3	ADDITIONAL DISTRICT MAGISTRATE(DEV.), MALDA.	7719360702/03512-253049	
4	ADDITIONAL DISTRICT MAGISTRATE(LR), MALDA.	7719360703/03512-252355	
5	ADDITIONAL DISTRICT MAGISTRATE(ZP), MALDA.	7719360704/03512-252328	
6	SUB-DIVISIONAL OFFICER(SADAR), MALDA.	7719360707/03512-252733	
7	SUB-DIVISIONAL OFFICER(CHANCHAL),MALDA.	7719360708/03512-252872	
8	DP&RDO, MALDA.	7719360709/03512-252393	
9	OFFICER-IN-CHARGE, DISASTER MANAGEMENT & CIVIL DEFENCE, MALDA.	7719360748/03512-252058	
10	NAZARATH DEPUTY COLLECTOR, MALDA	7719360719/03512-252330	
11	DDMO , MALDA	9073936737/9933308303	
12	SDDMO(SADAR), MALDA	9073936950	
13	SDDMO(CHANCHAL), MALDA.	8777831976	
14	BLOCK DEVELOPMENT OFFICER, H.C.PUR-I,MALDA	7719360731/9434738491/03513-255228	
15	BLOCK DEVELOPMENT OFFICER, H.C.PUR-II,MALDA	7719360732/9434738492/03513-255249	
16	BLOCK DEVELOPMENT OFFICER, CHANCHAL-I, MALDA.	7719360733/9434738494/03513-252223	
17	BLOCK DEVELOPMENT OFFICER, CHANCHAL-II, MALDA.	7719360734/9434738496/03513-265660	
18	BLOCK DEVELOPMENT OFFICER, RATUA-I, MALDA.	7719360735/9434738489/03513-266229	
19	BLOCK DEVELOPMENT OFFICER, RATUA-II, MALDA	7719360736/03513-282250	
20	BLOCK DEVELOPMENT OFFICER, MANIKCHAK, MALDA.	7719360737/03512-272326	
21	BLOCK DEVELOPMENT OFFICER, GAZOLE, MALDA	7719360738/9434738456/03512-235330	
22	BLOCK DEVELOPMENT OFFICER, BAMONGOLA, MALDA	7719360739/9434738458/03511-266339	
23	BLOCK DEVELOPMENT OFFICER,HABIBPUR, MALDA	7719360740/03511-252214	
24	BLOCK DEVELOPMENT OFFICER, OLD MALDA, MALDA.	7719360741/9434738459/03512-260239	
25	BLOCK DEVELOPMENT OFFICER, ENGLISHBAZAR, MALDA.	7719360742/03512-252297/220672	
26	BLOCK DEVELOPMENT OFFICER, KALIACHAK-I,MALDA.	7719360743/9434738341/03512-248626	
27	BLOCK DEVELOPMENT OFFICER, KALIACHAK-II, MALDA.	7719360744/9434738482/03512-248626	
28	BLOCK DEVELOPMENT OFFICER, KALIACHAK-III, MALDA.	7719360745/03512-222526	
CONTACT NO OF MALDA DISTRICT TRANSPORT (ADMINISTRATIVE)			
29	RTO, MALDA	7719360752/03512-252059	
30	MVI(TECH), MALDA	9434146655	
31	MVI(TECH), MALDA	9836764444	
32	MVI(NON-TECH), MALDA	9051466212	
33	MVI(NON-TECH), MALDA	7044339009	
34	ARTO, CHANCHAL, MALDA	7001246309/9434131790	
THE RESPONSIBILITY AMONGST THE MALDA DISTRICT LEVEL OFFICERS ATTACHED WITH CMOH, MALDA.			
35	CMOH, MALDA	9831048213/03512-254611/252280	
36	DY. CMOH-I, MALDA.	9434123980	
37	DY. CMOH-II, MALDA.	9475093320	
38	DY. CMOH-III, MALDA	9475125119	

39	MSVP, MALDA	8902762875/9433050510	
40	BMOH, BAMONGOLA, MALDA	9475877287/03511-261244	
41	BMOH,CHANCHAL-I, MALDA	8759517728/03513-253489/252375	
42	BMOH,CHANCHAL-II, MALDA	7686968222/03513-265239	
43	BMOH,ENGLISHBAZAR, MALDA	7548072470/03512-274699	
44	BMOH,GAZOLE,MALDA	9933371662/03512-230202	
45	BMOH,HABIBPUR, MALDA.	9433121012/03511-252345/252869	
46	BMOH, H.C.PUR-I, MALDA	9735753639/03513-255322/256057	
47	BMOH, H.C.PUR-II, MALDA	9804384057/03513-257237	
48	BMOH,KALIACHAK-I, MALDA	9614460992/03512-243785/245758	
49	BMOH,KALIACHAK-II, MALDA	9564214594/9434352618/03512-276208	
50	BMOH,KALIACHAK-III, MALDA.	9775291255/9434193308/03513-222550	
51	BMOH,MANIKCHAK, MALDA.	7890391168/9434176378/03512-272329	
52	BMOH, OLD MALDA, MALDA	8013482971/03512-261002	
53	BMOH, RATUA-I, MALDA	8145940228/03513-266242	
54	BMOH, RATUA-II, MALDA.	9775930597/03513-282228/282207	
CONTACT NO. OF FIRE SERVICE, MALDA.			
55	DIVISIONAL OFFICER, FIRE BRIGADE, ENGLISHBAZAR, MALDA.	9830841642/03512-278854	
56	O.C. FIRE STATION, CHANCHAL, MALDA.	8514908800/03513-252111	
57	FIRE STATION, HARISHCHANDRAPUR-I BLOCK,MALDA.	9593439087/03513-244121	
CONTACT NO. OF CIVIL DEFENCE, MALDA.			
58	Sr. S.O.I., CIVIL DEFENCE, MALDA.	9476484721/03512-252017	
CONTACT NO. OF IMPORTANT POLICE OFFICIALS.			
59	SUPERINTENDENT OF POLICE, MALDA.	9083270300/03512-252520	
60	ADDL. S.P.(HQ) , MALDA	9083270301/03512-252661	
61	ADDL. SP (RURAL), MALDA	9083270949	
62	SDPO, CHANCHAL, MALDA.	9083270305/03513-251092	
63	DY. SP(HQR.), MALDA	9083270302/03512-252148	
64	DY.SP(D&T), MALDA	9083270303/03512-252148	
65	DY. SP(DIB), MALDA.	9083270304/03512-252385	
66	DIO-I,DIB, MALDA	03512-252349	
67	DSP,DEB, INCHARGE	9434001088	
68	INSP. DEB	9836250868	
69	DIST. COMDT. (HQ ME GUARD)	9635111761	
70	IC,ENGLISHBAZAR PS , MALDA	9083270308/03512-252071	
71	IC, MALDA	9083270310	
72	CI, GAZOLE, MALDA	9083270306/03512-235327	
73	OC, GAZOLE , MALDA	9083270317	
74	IC, HABIBPUR, MALDA	9083070311/03511-252664	
75	O.C., BAMONGOLA, MALDA.	9083270318/03511-265555	
76	O.C., MANIKCHAK, MALDA	9083270316/03512-272333	
77	O.C., BHUTNI, MALDA.	9083270321	
78	I.C., KALIACHAK, MALDA.	9083270309/03512-244310	
79	I.C., BAISHNABNAGAR, MALDA.	9083270313/03512-204282	
80	O.C., MOTHABARI, MALDA.	8101493755/9733207404	
81	Ri, MALDA.	9083270325	
82	O.C., CONTROL ROOM , MALDA	9083270328	

83	CI, RATUA, MALDA	9083270307	
84	O.C., RATUA PS, MALDA	9083270319/03513-266222	
85	O.C., PUKHURIA, MALDA.	9083270320/03512-286211	
86	I.C., CHANCHAL PS, MALDA	9083270314/03513-252256	
87	I.C., HARISHCHANDRAPUR PS, MALDA.	9083270316/03513-255215	
CONTACT NO. OF PWD & OTHER OFFICIALS, MALDA.			
88	E.E. PWD MALDA DIVISION, MALDA.	9434366191/03512-252497	
89	E.E. PWD ELECTRICAL, MALDA	9007599599	
90	E.E. PHE, MALDA	9474433610	
91	E.E., PHE (ARSENIC), MALDA	9433470831	
92	E.E. IRRIGATION MALDA DIVISION, MALDA	9474737536	
93	E.E., AGRI. MECH. , MALDA	9433351028	
94	DI OF SCHOOLS(S.E.), MALDA	9434665538	
95	DI OF SCHOOLS(P.E.), MALDA	9830851808	
96	CHAIRMAN, DPSE, MALDA.	9832010010	
97	SDRF, MALDA	-	

Name of ICs and OCs of PSs, CIs & concerned Police officers in Malda with their contact Number.

SlNo.	Name of Police Station	Name of IC / OC	Mobile No.	Mob. No. of Duty officer
1	Englishbazar PS	Shri Amalendu Biswas	9083270308	7477784451
2	Kaliachak PS	Shri Ashis Das	9083270309 9836551310	7477784454
3	Baishnabnagar PS	Shri Tridip Pramanik	9083270313 9002722365	7477784455
4	Malda PS	Shri Santi Nath Panja	9083270310 9830131160	7477784448
5	Habibpur PS	Shri Purnendu Mukherjee	9083270311 9775401987	7477784449
6	Chanchal PS	Shri Sukumar Ghosh	9083270314	7477784440
7	Harishchandrapur PS	Shri Sanjay Kumar Das	9083270315	7477784441
8	DIO-I, DIB, Malda	Smt. Atreyi Sen	9083270324	03512-252349
9	CI Gazole	Shri Hiranmoy Hore	9083270306	03512-235338

10	CI Ratua	Shri Sanjay Ghosh	9083270307	03513-266090
11	RI Malda	Shri Sanjay Chhetri	9083270325	
12	Mothabari PS	SI Bitul Paul	9083270323 9609957049	03512-248655
13	Manikchak PS	SI Debobrata Chakraborty	9083270316 9733043304	7477784452
14	Ratua PS	SI Kunal Das	9083270319 9932098891	7477784442
15	Gazole PS	SI Haradhan Deb	9083270317 9733131477	7477784447
16	Bhutni PS	SI Simon Serpa	9083270321 9153559706	7477784453
17	Pukhuria PS	SI Jhatan Prasad	9083270320 9434063114	7477784443
18	Bamongola PS	SI Avishek Talukdar	9083270318 9051057557	7477784446
19	OC Traffic, Malda	SI Tarun Saha	9083270322 9836478444	7477784450
20	OC-Watch, DIB, Malda	SI Rabindra Nath Sinha	8918268545 7679183660	03512-252349
21	OC PCR, Malda	SI Dipankar Sarkar	8617500386	7477784445

Contact No. of District Disaster Management Section :

Sl. No	Name with Designation	Office	Residence	Mob No	
1	Sri Ashoke Kumar Ghosh, DDMO	03512-252058	Bharat Sevaashram	9933308303	
2	Sri Anil Kumar Gupta, SDDMO (Sadar)		Govt Housing, Malda	9733364660	
3	Sri Joydip Sengupta, SDDMO (Chanchal)			9434964224	
4	Sri Bibhuti Bhusan Halder, H/C			9832536415	
5	Sri Arun Kumar Saha (RE)			8250585109	
6	Sri Barid Goswami (RE)			7479153424	
7	Sri Santu Ghosh (Store Keeper)			7908402557	
8	Sri Protap Sarkar (Group D)			6295391584	
9	Safiul Shams (Group D)			Malda	9851380177
10	Suhana Eliza Parveen (CD Vol)			Sujapur	9064730427

Contact No. of Non Governmental Organizations:

Sl. No	Name of NGO's	Office	Residence	Mob No
1	IMA	03512-252132		-
2	Red Cross	03512-252093		980001811/9800459888
3	St. John	03512-252751		9434193341
4	Bharat Sevashram	03512-260459		8637847609
5	Ram Krishna Mission	03512-252479		03512252479
6	Lions club	03512-252398		9434186135
7	Rotary Club, Malda			9126215099
8	Malda Chamber of Commerce	03512-266028		9434206618
9	Sanskriti O Samj Unnayan Parishad	03512-267423		9434012392

Helipads/High Grounds:

Block	Sl. No.	Ground	Latitude	Longitude
Harishchandrapur-I	1	Harishchandrapur High School Ground.	25.4164417	87.8776409
	2	Tulsihata High School	25.0108312	88.1411123
	3	Kushida High School	25.5271221	87.9457112
Harishchandrapur-II	1	Bhaluka Irrigation Bunglow Ground.	25.2840129	87.8851056
	2	Teljana Irrigation Bunglow Premises.	25.3710357	87.8380134
	3	Doulat Nagar School Ground.	25.4211922	87.8294726
Manikchak	1	Manikchak Sikshaniketan	25.0679753	87.9032943
	2	Najirpur Football Ground.	25.1287689	87.9071015
Ratua-I	1	Samsi College Ground	25.2772843	88.0114901
	2	Ratua Football Ground	25.2004887	87.9259168
Ratua-II	1	Pukuria High School.	25.1466843	88.0167926

Kaliachak-III	1	South Malda College (Lakshmipur GP)	25.0402023	88.0281012
	2	Baishnabnagar High School Field.	25.2477523	88.296212

Englishbazar Block	Name & Location of Helipad & Air Dropping Sites	Situated within the area of	Lat & Long
	Play ground of Sovanagar High School	Sovanagar G.P	25.042267, 87.9766
	Play ground of Milki High School	Milki G.P	25.03195, 88.0003
	Play ground of Raigram High School	Amrity G.P	25.0221752, 88.0474484
	Play ground of Sattari High School	Binodpur G.P	24.9918, 88.03678
	Play ground of Nagharia High School	Fubaria G.P	25.0413, 88.02758
	Play ground of Budhia High Madrasah	Narhatta G.P	25.08711, 88.08513
	Play ground of Kamlabari Agnishikha Club & Library	Jadupur-I G.P	25.009347, 88.069979
	Play ground of Chandipur BRS High School	Kazigram G.P	24.98917, 88.08159
	Play ground of Kotwali High School	Kotwali G.P	25.0453, 88.11134
	Play ground of Gouriya High School	Mahadipur G.P	24.8852671,88.13796

GAZOLE BLOCK	Sites	Name of G.P	Latitude	Longitude
	Football Ground of Gazole High School	Gazole-I	25*12'50.457"	88*11'41.316"
	Tiakati High School Ground	Bairgachhi-II	25*11'45.384"	88*07'40.993"
	Football Ground of Panchpara	Gazole-II	25*13'07.918	88*09'35.694"
	Football Ground of near Uttar nowgram	Karkach	25*16'06.031"	88*13'00.000"
	Football Ground at Altore	Raniganj-II	25*10'41.498"	88*17'42.026"
	Football Ground at Ahil	Salaidanga		
	Football Ground of Raniganj High School	Raniganj-I	25*07'31.096"	88*15'55.231"

List of Truck Owner's Association with Contact Number

Sl. No	Name of owner's Association	Name of Association	Contact No	Details of Availability		
				6W	10W	12W
1	Sanjit Ghosh	Simanto Truck	9933323919	25-30	60	-
2	Jiaul Momin	Simanto Truck	9933366101			
3	Sameer Ghosh	Malda Truck (Gour Owner's)	9933040511	200	400	50
4	Anupam Banarjee	Malda Truck & Tankers Owner Association	9733156707	500	-	-

List of Ambulance with Contact Number (blocks wise)

Sl. No	Name of Block	Owner Name	Contact No		
1.	HCUR-II	Shamal Choudhary	9733344970		
		Ashok Mandal	9593932853		
		Aktar Hossain	9733354363		
		Asha das	7872917416		
		Sudipta Choudhary	9734910885		
		2	CHANCHAL-I	Shyamal Ch., Das	9733174678
				Hasin Mahamad	9007224334
				Hasin Mahamad	9007224334
				Kaliganj Udayganj Nabajagorani	9734087921
				Md. Abul Kashem	876883547
Md Samjujjoha	9083101765				
		Md Munjur Alam	9647806698		
		Ms Nuerey Alam Sarkar	9734163372		
		MulaiBari Jiban Bilkas Society	9733440246		
		MulaiBari Jiban Bilkas Society	9733440246		

3

RATUA-I

Ujjal Ghose	9932336414
Ujjal Ghose	9932336414
Ujjal Ghose	9932336414
Ujjal Ghose	9932336414
Swapan Pramanik	9563253714
Matiur Rahaman	9593220768
Pulak Das	9679416091
Santosh Saha	9932210694
Saiyad Ferdous Alam	9735947474
Sarif Sekh	9593759215
Badrul Hossain	9734195082
Badrul Hossain	9734195082
Pappu Roy	7076075197
Anwar Hossain, Ratua Ailpara	9734990116
Nasim Sarwar, Ratua Ailpara	9153649685
Aripful Rahaman, Ratua	9932169118
Md. Kakil, Ratua	9679084281
Kabir, Ratua	9734902607
Akbar Ali, Ratua	9775970131
Md. Yousuf Ali, Ratua	9733051835
Golam Rabbani, Ratua	7076439674
Abu Kalam, Ratua	9733237149
Chanchal Janakalyan Samity, Ratua	9932169118
Rahim Khan, Ratua	9733207113
Rahim, Ratua	9735135011
Saheb, Samsi	9733183526
Saheb, Samsi	9733183526
Khadibun, Samsi	9609771596
Pandab, Samsi	8016141108
Basu, Samsi	9733038160

4

MANIKCHAK

Tapas Basak	8337837074
Mithun Mandal	7718285251
Rajul Ali	9734797101
Srikanta Mandal	9734050103
Taleb Ansari	7872090927
Ujjal Poddar	9735995835
Mithu Mandal	8944084687
Bhim Pramanik	7797982247
Akbar ali	9733419040
Satrugna Mandal	8972624370
Radheshyam singha	7547967462
Debasish Ghosh	8768837162
Kinkor Ghosh	9735102742
Md. Sahabuddin	9734173634
Ganesh Mandal	9564463710

5

BAMONGOLA

Chiranjit Biswas	9635070511
Abhinay Samajder	9751857069
Anup Halder	9800090089
Bijoy Ghosh	9734978904
Ajit Shil	9635070731
Sanjib Sarkar	8116322049
Milan Deb	9733105303
Santu Das	9733143057
Asim Roy	9735939639
Utpal Swarnakar	9733360655

6

KALIACHAK-II

FituSk (Bangitola RH)	9733336030
AnuarulSk	8768443077
AnuarulSk	8641055583
Saukat Ali	947465683
Aktaar Alam	8641055583

	FatikSk	9775997524
	Sultana Khatun	8641055583
	AkhtarAlam	9679079434
	Anikul Islam	9733227209
	Abdul Ajj	9749043089
	UjirChowdhury	9775614729
	Anikul Islam	9733227209
	RintuSk	9775825283
	Abdul Alim	9733235713
7	Makimuddin	9733220398
	ZiaurRahaman	9734930153
	Serina Bibi	9593939712
	Rousana Khatun	7719215072
	Chanchal Janakalyan Samity	9593960247
	Raju Sk	7584887349
	Saddam Reja	8145792265
	Jhuma Khatun	7797859871
	Jhumpa Khatun	9593210115
	Saiful Islam	9932356857
	Khademul	9635874416
	Laxman Tudu	7407627746

CHANCHAL-II

List of Petrol Pump with Contact Number

1	Arun Smirity Service Station	03512-252986
2	Bengal Oil Companu	03512-252170

Contact Person of various Local vendor of Food Supplier of Malda District:

Name of Vender	Contact No	Location	Items supply
Sri Niranjan Agarwala	9434032274	Ratua	Chira-Gur
Sri Joysri Ram Chira Mill	9734920510	Ratua	Chira-Gur
Noor Jahan Enterprise	7908166730	Manikchak	Chira, Gur and Baby Food
M/s Mamchand Agarwala & Sons		Paranpur	Chira & Gur
Ganesh Vendor	9547880767	Bulbulchandi	Chira-Gur
Joy Sree Ram Chira/Muri Mill	9734066336	Pakua Hat	Chira & Muri
MARS International	9434231870	Mangolbari	Chira-Gur,baby food
Bablu Majumder	9475177609	Maheshpur	Chira, Gur and Baby Food
Jyoti Traders	7557018769	Bachamari/Mangalbari	Chira
Ghosh Enterprises	9434455970	Bashbari, Malda	Chira, Gur and Baby Food
Banwary Lal Agarwala	9434355721	Harishchandrapur	Chira
Malda District Service Cum-Marketing Industrial Cooperative Union Ltd	03512-323258	KJ Sanyal Road, Malda	Soyabin/Dal/Relief Pkt/Baby Food

Some Do's & Don't during Natural Calamity

Do's	Don'ts
Cyclone	
Check the house, secure loose titles, carry out repair works for doors and windows	Do not ignore warnings and to for sight-seeing near the sea.
Remove dead wood or dying trees that are lying close to the house, anchor removable objects like lumber piles, loose tin sheds, loose bricks, arbage cans, sign-boards etc which can fly in strong winds.	Do not allow children to play or near accumulated waters.
Demolish condemned buildings	Do not drive into water of unknown depth and current.
Keep some extra batteries for transistors	Do not eat food, which is affected by accumulated water.
Keep some dry non-perishable food always ready for emergency use.	Do not try to walk or drive through accumulated water.
Stay indoors and take shelter in the strongest part of your house.	Do not walk across bridges as they may collapse.
Listen to the radio and follow instructions	Never swim through fast flowing water.
Find some kind of shelter if you are caught in the open.	Do not walk through flowing waters-currents can be deceptive and shallow, fast moving water can knock you off your feet.
Disconnect all electrical mains and appliances and turn off gas.	Do not swim through fast flowing waters you may get sept away or struck by an object in the water.
Store or secure loose boards, corrugated iron,rubbish tins or anythis else that could become dangerous.	Do not reconnect your power supply until a qualified engineer has checked it.
Tape up large windows to prevent from shattering.	Do not smoke or use candies, lanterns or open flames
Believe in the official information and ignore rumours	Do not worry about your property too much. It is your life that is more important.
When a cyclone alert is on for your area, continue normal working but listen to the radio warnings	Do not return until advised after evacuation.
Stay alert Remember that a cyclone When your area is under cyclone warning get away from low lying beaches or other low lying area close to the coast.	Do not dry out building with mechanical dehumidifiers, as this may absorb all moisture quickly and cause additional damage.
Leave early before your way to high ground or shelter gets flooded.	Do not scrub or brush mud and other deposit from materials. This may cause further damage.
If your house is securely built on high round take shelter in the safer part of the house.	Do not let water-damaed papers alert means that the danger is within 24 hours.
Board up glass windows or put storm shutters in place.	Do not open any books or albums that were completely submerged. (Wet paper is very weak and will tear).
Provide strong suitable support for outside doors	Do not keep objects in dark hot stagnant air with high humidity, as these conditions encourage mold.
If you don not have wooden boards handy, paste paper strips on glasses to prevent splinters.	Do not try to separate buyndles of saturated paper.

Drought

Do's	Don't
Carry out early warning and drought monitoring on the basis of long, Medium and short term forecast.	Do not work in extreme heat anywhere
Arrange reasonable buffer-stock of food grain and fodder.	Do not waste water anywhere.
Ensure supply of good drinking water in rural area for human and livestock in drought affected areas.	Do not leave children or cattle alone outdoors
Assess fodder requirement in drought affected areas and locate pockets where shortages are likely to occur and arrange supplies from outside.	Do not depend on only agriculture based occupations.
Encourage fodder cultivation, wherever feasible.	Do not encourage deforestation and cutting of trees.
Rejuvenate traditional rainwater systems viz River, Nadis, Tankas, Khadins etc.	Do not follow single cropping pattern
Encourage rainwater harvesting for both the drinking and cropping	Do not grow water-intensive crops like paddy, sugar, etc which consume a lot of water.
Strengthen watershed management and irrigation system.	Do not delay in providing agricultural input support like seeds and fertilizers to the farmers.
Promote cultivation of potatoes, groundnut, oilseeds and maize.	Do not forget to involve community and self help groups in drought management.
Ensure management of human and livestock population to reduce pressure on fragile arid ecosystem.	Do not take up new initiatives for execution without the approval of the appropriate authority.
Encourage social forestry/joint Forest Management.	Do not discriminate in providing relief to the affected people.
Ensure timely availability of credit, postponement of revenue collection and repayment of short-term agriculture loan.	Do not allow inclusion of the names of ineligible persons in the list for gratuitous assistance.
Give boost to appropriate land-use planning (inter-cropping system)	Do not procure fodder on any other price than fixed by the State Government.
Consume food as per your basic requirement	Do not allow more than 500 cattle in each cattle camp.

Earthquake

Do's	Don't
Repair deep plaster cracks in ceilings and foundations	Do not rent apartments in high rise multistoried buildings, without any earthquake proof.
Get expert advice if there are signs of structural defects.	Do not rent houses adjacent to weakly constructed vulnerable old houses or any other weak structure, which can fail on your house during earthquake.
Anchor overhead lighting fixtures to the ceiling	Do not rush to the doors or exits.
Consult structural engineers for earthquake safety before constructing buying or renting a house	Do not use the elevators
Follow Bureau of Indian Standards (BIS) codes relevant to your area for building standards	Do not go close to broken windows, mirrors, chimneys and furniture.
Fasten shelves securely to walls.	Avoid places where there are loose electric wires and do not touch any metal object in contact with them.
Place large or heavy objects on lower shelves	Do not re-enter badly damaged buildings and don't go near damaged structures.
Store breakable items such as bottled foods, glass and bone china in low, closed cabinets with latches.	Be aware that some earthquakes are actually foreshocks and a large earthquake might occur. Do not move to unsafe places.
Brace overhead light and fan fixtures	Do not come near the building, trees, streetlights and utility wires.
Repair defective electrical wiring and leaky gas connections. These are potential fire risks. Secure a water heater, LPG cylinder etc by strapping it to the wall studs and bolting it to the floor.	Do not enter the building until the shaking stops. The greatest danger exists directly outside buildings at exits and alongside walls. Most earthquake-related casualties result from collapsing walls, flying glass and falling objects.
Store weed killers, pesticides and flammable products securely in closed cabinets with latches and on bottom shelves.	Do not use roads, bridges, or ramps that might have been damaged by the earthquake.

Identify safe places indoors and outdoors	Do not light a match move about or kick up dust open your mouth.
-------------------------------------------	------------------------------------------------------------------

Fire (Building : Offices and residences)

Do's	Don't
Install smoke alarms	Do not loose calm
Place smoke alarms on every level in the building	Do not paint over smoke/heat detectors.
Test and clean smoke alarms once a month and replace batteries at least once a year	Do not let trash,such as old newspapers and magazines etc accumulate.
Replace smoke alarms onec every 10 years	Do not smoke near flammable liquids
Review escapes routes with your family	Do not smoke in bed or when drowsy or medicated.
Make sure windows are not nailed or permanently shut.	Do not overload extension cords or outiets, if you need to plug in two or three applicaces.
Consider escape ladders if your building has more than ove level and ensure that burglar bars and othr antitheft mechanisms that block outside window entry are easily opened from the inside.	Do not leave electrical appliance or equiprment continued to be energized when they are not in use,especially after office/working hours.
Clean out storage areas. Never use gasoline benzene,naphtha or similar flammable liquids indoors	Do not put liquid or thig that is flammable or combustibile near an electrical switchboard or an enclosure containing electrical components.
Sote flammable liquids in approved containers in well-ventilated storage areas.	Do not touch bare electrical wiring.
Be careful when using alternative heating sources	Do not enter a damaged building, if you detect heat or smoke.
Place heaters at least three feet away from flammable matrials. Make sure the floor and nearby walls are properly insulated.	Do not try to open a safe or strong box as it could hold intense heat for several hours.
Keep matches and lighters up high away from children and if possible in a licked cabinet.	Do not use cardboard boxes wooden crates or othr receptacles that are made of combustibile material as makeshift rubbish bins at your place.
Have the electrical wiring in your building checked by an electrician.	Do not accumulate unwanted items at your place.
Inspect extension cords for frayed or exposed wires or loose plugs.	Do not use corridors walkways or passageways that from part of the emergency escape route at your place.
Make sure outlets have cover plates and no exposed wiring.	Do not remove ceiling boards or use ceiling voids for storage.
Escape through a window, if door is hot, if you cannot escape, hang a white or light-colored sheet outside the window,alerting fire fighters to your presence	Do not use fragile containers to store flammable liquids.
Open the door slowly and ensure fire and/or smoke is not blocking your escape route.	Do not use or operate darty or greasy equipment/machinery.
Crawl hugging to ground to save from inhaling smoke while escaping through building on fire	Do not leave heavy machinery operating or running unattended.

Heat Wave

Do's	Don't
Drink 2 to 3 litres of water per day or sufficient water as often as possible,een if not thirsty	Do not go out in the hot sun especially between 12 noon to 3 pm.
Wear lightweight light-coloured,loose,porous natural fibre clothes	Do not undertake strenuous activities, avoid work outside during 12 noon to 3 pm
While traveling, carry water with you.	Do not consume alocoholic,caffeinated or carbonated drinks which dehydrate the body.
If you work outside keep hat and clothing damp.	Do not eat high-protein foods which increase metabolic heat.
Use umbrella, sunscreen as sub burm limits your ability to cope up with heat.	Do not leave children or pets in parked vehicles.
If you suffer chronic illness or feel ill, sea a doctor	Do not come directly in touch with sunlight.
Use ORS, home made indigenous drinks like lassi,torani (rice water), lemon sharbat (lemon water), butter milk etc which help to rehydrate the body and protect us from sunstroke.	

PRADHAN AND UPA PRADHAN

Sl. No.	Name of Block	Name of GP	Name of the Prodhan	Mobile No.	Name of the Upa-Prodhan	Mobile No.
1	HARISHCHANDRAPUR-I	TULSHIHATTA	SAKUNTALA SINGHA	8116569866	MAHOBA BIBI	7407648515
2	HARISHCHANDRAPUR-I	MAHENDRAPUR	JOYNAB NESHA	8145513420	ABUL KALAM	9932564758
3	HARISHCHANDRAPUR-I	KUSHIDA	AAKTARI KHATUN	9647806910	MD NOOR AJAM	8906960992
4	HARISHCHANDRAPUR-I	RASHIDABAD	PUSHPA RABI DAS	9064936883	SAMMI AKHTAR	9734138479 6296960780
5	HARISHCHANDRAPUR-I	HARISHCHANDRAPUR	RISBA KHATUN	7719225335	SHEFALI DAS	7872712279
6	HARISHCHANDRAPUR-I	BOROI	SONAMANI SAHA	8016278432	SK. MUSTAK HOSSAIN	9635649211
7	HARISHCHANDRAPUR-I	BHINGOLE	BIMAN BIHARI BASAK	9733371405	SEKENDAR BOKS	7384980245
8	HARISHCHANDRAPUR-II	SULTANNAGAR	WAHEDA KHATUN	9593742788	OWIDUR RAHAMAN	8250965511
9	HARISHCHANDRAPUR-II	ISLAMPUR	SUSAMA MANDAL	9734957484	ABDUS SAMAD	9593810774
10	HARISHCHANDRAPUR-II	SADLICHAK	INDRAJIT SARKAR	9733019899	MANOWARA BIBI	8001538252
11	HARISHCHANDRAPUR-II	DAULATPUR	MD. TAFAZZAL HOQUE	9733286356 9933318088	MADHABI DAS	8759398171 7469913937
12	HARISHCHANDRAPUR-II	DAULATNAGAR	MD. NAJIBUR RAHAMAN	9593811340	ASIMA BANU	9733065624
13	HARISHCHANDRAPUR-II	BHALUKA	MINU MUSAHAR	7407732395	MD. MOJIBUR RAHAMAN	9647407947
14	HARISHCHANDRAPUR-II	MASHALDAH	NILUFAR YEASMIN	9593257618	MD. ISMAIL	9733060289
15	HARISHCHANDRAPUR-II	MALIOR-I	MST. SETARA KHATUN	9733109875	PINKIBALA RABIDAS	9564128020
16	HARISHCHANDRAPUR-II	MALIOR-II	TORINA KHATUN	8768663507	DILIP DAS	7718182690
17	CHANCHAL-I	ALIHANDA	MANOWARA		MD. BAREK ALI	
18	CHANCHAL-I	BHAGABANPUR	SABINA PARVIN		SYED ARIF ALI	
19	CHANCHAL-I	CHANCHAL	AJMERI KHATUN	7029539282	UTPAL TALUKDAR	9733393736
20	CHANCHAL-I	KALIGRAM	REZAUL KHAN	9851474781	ACHIN DAS	9563521748
21	CHANCHAL-I	KHARBA	PARVINA KHATUN (BIBI)	9832566743	SAIMUDDIN	9641047791
22	CHANCHAL-I	MAHANANDAPUR	GOPAL CHOWDHURY,	9002059659	MAHABUL ALAM	8145974741
23	CHANCHAL-I	MOKDAMPUR	SAHADEB CHANDRA MANDAL	9679210082	MUSTAQ ALAM	956324104
24	CHANCHAL-I	MOTIHARPUR	PAPI DAS	9735980022	MST. PINKI KHATUN	7063228337

25	CHANCHAL-II	BHAKRI	MD.NOOR HOSSAIN	7797626686	SUMIT KR. DAS	9851406526
26	CHANCHAL-II	CHANDRAPARA	CHAMPA SARKAR	9647838533/ 7477493129	AZIZUR RAHAMAN	9733297570
27	CHANCHAL-II	DHANGARA BISHANPUR	RAFIKA	9733234024	RUKSENA KHATUN	9734159391
28	CHANCHAL-II	JALALPUR	MOSA MASTARA KHATUN	7407650179	MOST FERDOUSI KHATUN	9733733735
29	CHANCHAL-II	KSHEMPUR	SAMPA RANI (MANDAL) SINHA	9733197281/973340 0200	LAXMI PRAON	9775853821
30	CHANCHAL-II	Gourhand	PUSPA ORAON	9002599034	JAYANTA SARKAR	9563405860
31	CHANCHAL-II	Malatipur	Abdul Halim	9733152304	Mausumi Khatun	9733280399
32	RATUA-I	MAHANANDATOL A	KIRAN MAJHI	9647607464	FIRDAUSHI BEGAM	9153719742
33	RATUA-I	BILAIMARI	LUTFUR RAHAMAN	9564332079	SENTU AALAM	9925292091
34	RATUA-I	KAHALA	BABY MONDAL	8327820560	NAHEDA KHATUN	9083975006
35	RATUA-I	BAHARAL	JUCY SAHA (MONDAL)	9734040002	HIMMAT KHAN	8768911483
36	RATUA-I	CHANDMONI-I	RABIUL	9733210741	MOST AKHTARA KHATUN	7797423116
37	RATUA-I	CHANDMONI-II	JOSNARA KHATUN	9733434543	MAMTAJ BEGUM	8768837615
38	RATUA-I	SAMSI	SHRABAN KUMAR DAS	9735335397	AMIRUL HOQUE	9734724156
39	RATUA-I	BHADO	BIBI SETARA	9733476294	NO ELECTION HELD	
40	RATUA-I	RATUA	SK ALAMGIR REJA CHOWDHURY	9775235268	PINKI MANDAL	9593374782
41	RATUA-I	DEBIPUR	PANKAJ MISHRA	7609930683	PURJA MANDAL	9614275593
42	RATUA-II	ARAI DANGA	CHANDANA MANDAL	9635100891	SAMPA GHOSH	7063662010
43	RATUA-II	PIRGANJ	MAINUR	9547718198	MD. ARMAN ALI	9002933265
44	RATUA-II	PARANPUR	JASMIN BIBI	9775309897	SASTHI CHANDRA DAS	9733147953
45	RATUA-II	PUKHURIA	MD BAFATULLAH	9932940121	ASRAFUL HOQUE	9932733648
46	RATUA-II	SAMBALPUR	SABINA KHATUN	9749710795	AMBIA NASRIN	9932983415
47	RATUA-II	SRIPUR-I	ROSNARA	9593296197	NURUL ISLAM	9002910603
48	RATUA-II	SRIPUR-II	BIBI SERINA	8641913874	ANIKUL HOQUE	7797910097
49	RATUA-II	MAHARAJPUR	AFSANA KHATUN	8016441823	SUKUMAR RABIDAS	8016445193
50	BAMANGOLA	BAMANGOLA	PAMPA BARMAN (MANDAL)	9564036025	HIMANGSHU MANDAL	
51	BAMANGOLA	CHANDPUR	SUBHASH BHAKTA	9083947746	RAJITA KISKU	9593306264
52	BAMANGOLA	PAKUAHAT	SIMA MAJUMDER GHOSH	9733419120	MINI MURMU	9734182778
53	BAMANGOLA	GOBINDAPUR- MAHESHPUR	PRATIMA MANDAL	9137128798	HIRAMONI MARDI	9932795250
54	BAMANGOLA	JAGDALA	TULSI MONDAL	9734397717	SADHAN CHANDRA MANDAL	9733921339
55	BAMANGOLA	MADNABATI	RANJITA HALDER (MAJUMDER)	7076173332	SATYA RAM	9614313233
56	HABIBPUR	SRIRAMPUR	ASHALATA MARDI	9679135956	PANDAB SINGHA	9800019327
57	HABIBPUR	AIHO	ANITA SAHA	7797188189	BASANA MANDAL	8670983414
58	HABIBPUR	HABIBPUR	GOPIKA MANDAL	9733081627	RAJKUMAR BARMAN	9735971028
59	HABIBPUR	BULBULCHANDI	RAJIB DAGA	9775889319	FANI MUNDA	7363932444
60	HABIBPUR	DHUMPUR	SWAPAN BARMAN	8637083838	RITA CHOWDHURY	7547943107

61	HABIBPUR	KANTURKA	RABILAL HANSDA	8944827636	SHEFALI MARDI	9734191180
62	HABIBPUR	JAJAIL	EVA SOREN	8016813191	SATYABHUSAN MALLICK	9933640767
63	HABIBPUR	RISHIPUR	GOURI SARKAR (SINGHA)	7319575134	CHANDANA DAS (MANDAL)	7319205276
64	HABIBPUR	BAIDYAPUR	BABITA BHOWMIK	8001201110	SRINATH SOREN	7478444495
65	HABIBPUR	AKTAIL	GAYETRI BARMAN	9733226639	SHYAMAL HASDA	8372984434
66	HABIBPUR	MANGALPURA	BAIJANTI SARKAR	9734189831	PHILIP MARDI	9547972746
67	GAZOLE	ALAL	LAKSHMI HALDAR	9002126171	FARUKH HUSSAIN	8944971544
68	GAZOLE	BABUPUR	NARGIS PARVIN	9735013284	KAPU HEMBRAM	8167370919
69	GAZOLE	BAIRGACHHI-II	SUBODH SARKAR	7319013980	DEBI TUDU	9933716035
70	GAZOLE	BAIRGACHHI-I	BHARAT CHANDRA MANDAL	9593976239	NASIMA	9932830607
71	GAZOLE	CHAKNAGAR	SADHU CHARAN SARKAR		GOPAL BALO	
72	GAZOLE	DEOTALA	SULTANA RAJIYA	7872962236	MANGAL MURMU	9734926873
73	GAZOLE	GAZOLE-I	BINDU PUJHAR(MAL)	9932138647	KAJAL KUMAR KUNDU	9735176174
74	GAZOLE	GAZOLE-II	JAYANTI BARMAN (SARKAR)	9851504995	NIRMAL MUDI	9647591085
75	GAZOLE	KARKACH	FULMANI HASDA	8944995666	BANCHARAM SARKAR	9002513977
76	GAZOLE	PANDUA	SONIA HEMBRAM	9734077323	CHUMKI ROY	
77	GAZOLE	MAJHRA	KAMAL KRISHNA DHALI	9609963162	BAHA SOREN	7872255977
78	GAZOLE	RANIGANJ-I	SANJIT DAS	8972112360	BASANTI HANSDA	8974302836
79	GAZOLE	RANIGANJ-II	PRAVATI MURMU	9932116937	DEBABRATA ROY	9064587249
80	GAZOLE	SALAI DANGA	SANJOY BESRA	7047955753 9382828892	SADHANA BISWAS	7477681686
81	GAZOLE	SAHAJADPUR	URMILA ROY	7602351895	NURTAJ ALI	8768750703
82	OLD MALDA	MAHISHBATHANI	RAJINA	9800762818 9547699466	REJAUL HOQUE	9679318450
83	OLD MALDA	JATRADANGA	ALI NUR HOQUE	8918927917	SATABDI SARKAR	9800005474
84	OLD MALDA	SAHAPUR	UKIL MANDAL	7699277199	MANDIRA MANDAL (DAS)	9851540974
85	OLD MALDA	MANGALBARI	SURAIYA BIBI	8927629179	GOUTAM DAS	8536979785
86	OLD MALDA	MUCHIA	SUBHALAXMI GAIN	8170011365	KHOKAN SARKAR	9614051720
87	OLD MALDA	BHABUK	LAKSHIRAM HANSDA	7384054473	PROBHU NATH DUBE	7699116262
88	ENGLISH BAZAR	BINODPUR	RITA CHOWDHURY	9679357833	AMIN MIA	9434920786
89	ENGLISH BAZAR	MILKI	SK NIZAM ALI (BACHHU)	9593850793	MD. TAREK ALI	9593306922
90	ENGLISH BAZAR	KAZIGRAM	SATYAJIT CHOWDHURY	9733227311	SAHID ISLAM	9733018841
91	ENGLISH BAZAR	JADUPUR-II	MD. SAJJAD ALI	9564955252	PURNIMA CHOWDHURY	7797278587
92	ENGLISH BAZAR	FULBARIA	ROHIMA BIBI	9733237899	BABLU SEKH	7550827313
93	ENGLISH BAZAR	NARHATTA	TOZIBUR RAHAMAN	7699883633	BASANTI MANDAL	9647879823
94	ENGLISH BAZAR	KOTWALI	TARUN GOSWAMI	8653714666	PROSENJIT DAS	9064793298
95	ENGLISH BAZAR	AMRITY	SARASWATI RAJAK	8371852980	BIPLAB MANDAL	9734135501
96	ENGLISH BAZAR	SOVANAGAR	RAKHI ROY	9734192907	MST SAKILA BIBI	9593833252
97	ENGLISH BAZAR	JADUPUR-I	AYESHA YASMIN	7098688476	EMTIAB HASAN	943420691
98	ENGLISH BAZAR	MAHADIPUR	KRISHNA SUTAR	8436014690	KHALID BISWAS	993353764
99	MANIKCHAK	DHARAMPUR	NAHARUL SK	9064558649	BALAI SAHA	8016842698

100	MANIKCHAK	CHOWKI MIRDADPUR	MAMPI RAJAK	7407478201	ASHIBUL ALI (PINTU)	9609709602
101	MANIKCHAK	GOPALPUR	SEMA BIBI	7364806935	MAMTAJ BIBI	7407580417
102	MANIKCHAK	DAKSHIN CHANDIPUR	AJAY KUMAR MANDAL	9647405463	RITA SARKAR	7797793470
103	MANIKCHAK	ENAYETPUR	ABU KALAM AZAD (APEL)	9593276988	MST. MEHEBUBA PARVEEN	9733243503
104	MANIKCHAK	UTTAR CHANDIPUR	BIUTY BIBI	7718713722	SAMAR MANDAL	9733523315
105	MANIKCHAK	MANIKCHAK	BEAUTY MANDAL	9564720232	SANKAR MANDAL	9775824926
106	MANIKCHAK	MATHURAPUR	MILAN MONDAL	6296047575	UTTAM KARMAKAR	9733394412
107	MANIKCHAK	NAZIRPUR	PAMPA SARKAR (SAHA)	7363931868	UDAY MANDAL	9733378866
108	MANIKCHAK	NURPUR	SK SUKIT	9733360295	MAJRA KHANAM	9933116403
109	MANIKCHAK	HIRANANDAPUR	KAJAL MANDAL	9593950582	ASHA RANI MANDAL	9733062434
110	KALIACHAK-I	SILAMPUR-I	SELIMA BIBI	9647372425	SELIM AKHTER	9641863053
111	KALIACHAK-I	SILAMPUR-II	MST RESHMA BIBI	9733431333	JAMSED SEKH	9564654787
112	KALIACHAK-I	ALINAGAR	RUMI BIBI	8768004553	MD LUTFUR RAHAMAN	9733189761
113	KALIACHAK-I	GAYESHBARI	MOSA NAIMA KHATUN	9563062616	KOHINUR	9734789360
114	KALIACHAK-I	ALIPUR-II	MST PARVEEN BIBI	7908138427	MST RUMA BIBI	8116289010
115	KALIACHAK-I	KALIACHAK-I	MD AMIRUL SK	9733191739	SABINA KHATUN	9735072616
116	KALIACHAK-I	ALIPUR-I	NUR-E-SHARIFA BANU	9434641279	SK AFNUR	9733219607
117	KALIACHAK-I	JALALPUR	MD JULFIKAR	9434411530	UMME SALMA	9733339516
118	KALIACHAK-I	BAMONGRAM MOSHIMPUR	SAMENUR	9800916530	MASUMA BIBI	9564243811
119	KALIACHAK-I	SUJAPUR	MD ARIF ALI	9614220792	SULTANA	9733248706
120	KALIACHAK-I	MOZAMPUR	AFROJA KHATUN	7551876782	MOSA AYESHA KHATUN	9734611092
121	KALIACHAK-I	JALUABADHAL	HIRAMATI MANDAL	9679167933	AITUL ISLAM	9734034630
122	KALIACHAK-I	NAWDA JADUPUR	ASARUDDIN SK	9735778030	MD BAHARI ALAM	8926605880
123	KALIACHAK-I	KALIACHAK-II	SALMA BIBI	6295221124	MD AMIRUL KOYESH	6294228958
124	KALIACHAK-II	UTTAR PANCHANANDAPUR-I	RIJIYA BIBI	9851870451	ABDUL HOQUE	9735060150
125	KALIACHAK-II	RAJNAGAR	DHANI RANI MANDAL	9775412588	CHINU SK	7407819354
126	KALIACHAK-II	UTTAR LAKSHMIPUR	NUR ASMIN KHANAM	9733129762	BASUDEB MANDAL	7407052355
127	KALIACHAK-II	RATHBARI	SAHANARA KHATUN	9635553201	SANDIP SWARNAKAR	9593225489
128	KALIACHAK-II	UTTAR PANCHANANDA PUR-II	ANJANA MANDAL (SARKAR)	9735063177	SANTANA GHOSH	9735551054
129	KALIACHAK-II	HAMIDPUR	JAREKA BIBI	9593754677	PARUL MANDAL	9734330643
130	KALIACHAK-II	BANGITOLA	MST. SANTARA KHATUN	7407101568	PUTUL CHOWDHURY	8170956013

131	KALIACHAK-II	GANGAPRASAD	AMINUL ISLAM	9733238286	MINA MONDAL	9800846120
132	KALIACHAK-II	MOTHBARI	MOSA. NILUFA IYASMIN	6295151675	SHAHIDUL SEKH	9775461810
133	KALIACHAK-III	AKANDABERIA	SARASWATI MANDAL	9002280544	SANDHYA MANDAL	7551822463
134	KALIACHAK-III	BAKHRABAD	MASTARA KHATUN	9735935507	MALA MANDAL	6294413594
135	KALIACHAK-III	BEDRABAD	RITA GHOSH	9734171072	RUKSENA	9733413866
136	KALIACHAK-III	BHAGABANPUR	MOSTAQUE HOSSAIN	973337555	TUMPA SAHA	9733397703
137	KALIACHAK-III	BIRNAGAR-II	SOMA ROY	9734920287	RUKSENA KHATUN	9593647720
138	KALIACHAK-III	CHARIANANTAPUR	SAHANARA BIBI	9733084746	GITA MANDAL	9734114689
139	KALIACHAK-III	KUMBHIRA	BULBUL SARKAR	7319155855	DEZI KHATUN BIBI	9609641875
140	KALIACHAK-III	SAHABAJPUR	BEBY MANDAL	8617660010	BASANTI MANDAL	9609781507
141	KALIACHAK-III	SAHABANCHAK	RIKO KHATUN	9939240624	BADAL MIA	7063406806
142	KALIACHAK-III	KRISHNAPUR	MESER ALI	9733120153	TANUSHREE MANDAL	7076165316
143	KALIACHAK-III	LAXMIPUR	YASHODA KUMARI MANDAL	6294702639	MASEDA BIBI	9733386437
144	KALIACHAK-III	BIRNAGAR-I	SIMA HALDAR ROY	7365825351	NO ELECTION HELD	
145	KALIACHAK-III	GOLAPGANJ	SABINA YASMIN	8348809252	PREMCHAND MANDAL	9851491851
146	KALIACHAK-III	PARDEONAPUR-SOVAPUR	SUSMITA RABIDAS	8162072052/ 9614642943	BADAL SEIKH	9153812832/ 8768374570

**BLOCK WISEs COUNTRY BOAT & MECHANISED BOAT DEPLOYMENT DETAILS
WITH CONTACT NO. & NAME OD BOATMAN**

Harischandrapur-I Development Block

Sl. No.	Name	Father name	Address	Contact no
1	Noor md	Sk Ainal	Rashidpur	9647205345
2	Sk Idul	Sk Taju	Rashidpur	9647205345
3	Sk Rajjak	Noor Md	Rashidpur	9535215535
4	Jaherul	Afjal	D Saldah	9733118278
5	Manjur	Safiruddin	D Saldah	964770296
6	Mafijul Hoque	Basiruddin	Ranipura	8609336002

Harischandrapur-II Development Block

<i>Sl No</i>	<i>Name</i>	<i>Fathers Name</i>	<i>Address</i>	<i>Contact No</i>
1	Noor Md	Sk Ainal	Rashidpur	96472-05345
2	Sk Idul	Sk Taju	Rashidpur	96472-05345
3	Sk Rajjak	Noor Md	Rashidpur	95635-21553
4	Sk Sajjad	Noor Md	Rashidpur	96477-73091
5	Durga Yadav	Naresh Yadav	Par Bhaluka	83709-66205
6	Mantu Mahaldar	Kinkar Mohaldar	Hatichhapa	97341-49701

Chanchal-I Development Block

Sl. No.	Name of Boat Owner.	Father's Name	Address	Contact No.
01	HANIF ALI	-	Udayganj	9641748510
02	DANESH ALI	-	Khidirpur	9932334654
03	HELAL	-	Khidirpur	9932135227
04	BELAL	-	Sripatipur	9002320038
05	SOLIMUDDIN	MUSTAK ALI	Uttar Kaliganj	9564812297
06	MUSTAK ALI	MOFILUDDIN	Uttar Kaliganj	9609734905
07	MANSUR ALI	RAJUDDIN	Uttar Kaliganj	9647710461
08	KHABIRUDDIN	MUSTAK ALI	Uttar Kaliganj	7797372599
09	MOSLIMUDDIN	MOFILUDDIN	Uttar Kaliganj	8695137293
10	MANJARUL HOQUE	LATIFUR RAHAMAN	Jotchandi	8001935244
11	MINAJ ALI	MOSLIMUDDIN	Uttar Kaliganj	7478694126
12	NAZIMUL HOQUE	AFAJUDDIN	Ratot	9733371387

Ratua-I Development Block

Sl. No.	Name of Boat Owner	Father's name	Address	Contact No.
1	Atul Ghosh	Panchu Ghosh	Vill: Balupur Diara P.O: Balupur Dist. Malda	9735425362
2	Durga Yadav	Naresh Yadav	Vill: Bankutola P.O: Sambalpur Dist. Malda	9733103118
3	Basukinath Yadav	Jamuna Yadav	Vill: Bankutola P.O: Sambalpur Dist. Malda	9733208522
4	Bikash Mandal	Chandrakanta Mandal	Vill: Janjalitola P.O: Maniknagar Dist. Malda	9733162637
5	Muktar	Saifuddin	Vill: Nayabilaimari P.O. Bilaimari Dist. Malda	9733396727
6	Jinnat Ali	Amtaz Ali	Vill. Ratanpur P.O. Bilaimari Dist. Malda	7602744879
7	Sushil Yadav	Rasiklal Yadav	Vill. Bodharamtola P.O. Mahanandatola Dist. Malda	9735081631
8	Tulsi Mandal	Kuttu Mandal	Vill. Jitutola P.O. Mahanandatola Dist. Malda	9134473200
9	Sukhen Choudhury	Amir Choudhury	Vill. Piyari Sarkartola P.O. Mahanandatola Dist. Malda	9564053300
10	Kalachad Choudhury	Jagadish Choudhury	Vill. Sudamtola P.O. Mahanandatola Dist. Malda	9733137289
11	Baiju Mandal	Pachu Mandal	Vill. Chaitutola P.O. Mahanandatola Dist. Malda	8348934312
12	Dayal Mandal	Golak Mandal	Vill. Maliramtola P.O. Mahanandatola Dist. Malda	9775735450
13	Laxman Mandal	Bhujan Mandal	Vill. Kotualy P.O. Mahanandatola Dist. Malda	9734956047
14	Biren Mandal	Upen Mandal	Vill. Nabagram P.O. Mahanandatola Dist. Malda	9775284738
15	Chhottu Jadav	Bramhadev Yadav	Vill. Bhaluka P.O. Bhaluka Dt. Malda	9733103118
16	Mainul Hoque	Abdul Basir	Vill. Mahanandatola P.O. Mahanandatola Dt. Malda	9733201020
17	Bhabesh Mandal	Fekan Mandal	Vill. Mahanandatola P.O. Mahanandatola Dt. Malda	9733189532
18	Haridas Mandal	Khoka Mandal	Vill. Mahanandatola	7872890182

			P.O. Mahanandatola Dt. Malda	
--	--	--	---------------------------------	--

Manikchak Development Block

Sl. No.	Name of Boat man	Contact No.	Carrying Capacity
1	Philip Mandal	9547878633	50 persons
2	Bikash Mandal	9775869569	50 persons
3	Nipen Mandal	7718384902	45 Persons
4	Pawak Mandal	8670370343	65 Persons
5	Nagen Mandal	7872293874	55 Persons
6	Bapi Mandal	7076636151	50 Persons
7	Choton Mandal	7479275927	40 Persons
8	Janardhan Mandal	9775884094	40 Persons
9	Nurul Hoque	7047716475	70 Persons
10	Deben Mandal	9609338043	70 Persons
11	Tilak Chand Chowdhury	7076968049	70 persons
12	Bablu Mandal	8116704125	70 persons
13	Jullur Rahaman	9593240245	70 persons
14	Kanchan Mandal	8768154183	65 Persons
15	Tahir Ali	9734970590	10 persons
16	Mojibar Rahaman	7364927210	10 Persons
17	Sankar Mandal	9679757108	Country Boat (D. Chandipur)
18	Dilip Mandal	8167313928	Country Boat (D. Chandipur)
19	Gopinath Chowdhury	7477538660	Country Boat (D. Chandipur)
20	Sudam Chowdhury	7407479343	Country Boat (D. Chandipur)
21	Hajrat Ali	8670706211	Country Boat (D. Chandipur)

Kalaichak-II Development Block

Sl. No.	Name of Boat Owner	Contact No.	Gram Panchayat	Type of Boat	Tagged Official
1	Ghanashyam Mandal	9563831634	Hamidpur G.P	Small size bhutbhuti	Ashok Saha, Secretary, Hamidpur G.P.,7908038563
2	Sanatan Mandal	9734957349	Hamidpur G.P	Small size bhutbhuti	
3	Khalek Sk	7872518641/ 9933124494	Rajnagar G.P.	Small size bhutbhuti	Md DaudHossein, EA, RajnagarG.P., 9733396998
4	Sattar Ali	9733146058	Uttar Panchanandapur-I G.P.	Small size bhutbhuti	Md. MobarokSk, EA, Uttar Panchanandapur-I G.P.,9932611583
5	RofikSk	9134665949	Uttar Panchanandapur-I G.P.	Small size bhutbhuti	
6	SaidulHoque	9563262536	Uttar Panchanandapur-I G.P.	Small size bhutbhuti	
7	EnamulHoque	9733018485	Uttar Panchanandapur-I G.P.	Small size bhutbhuti	
8	Bharat Mandal	7076582522	Uttar Panchanandapur-I G.P.	Small size bhutbhuti	
9	NuhuSk	9563659861/ 9735089005	Uttar Panchanandapur-I G.P.	Small size bhutbhuti	Md. Najrul Islam,
10	PoltuSk	9733108894	Uttar Panchanandapur-II G.P.	Small size bhutbhuti	

11	UjirSk	9733108894	Uttar Panchanandapur-II G.P.	Small size bhutbhuti	EA, Uttar Panchanandapur-II G.P.,9733465672
12	TapanMandal	8158082181	Bangitola G.P.	Country boat(Rowing)	Abdul NaserDewan, EA, Bangitola G.P., 9609781141
13	RajkumarMandal	7076048171	Bangitola G.P.	Country boat(Rowing)	
14	RatanMandal	8016852528	Bangitola G.P.	Country boat(Rowing)	
15	DilipMandal	8016852528	Bangitola G.P.	Country boat(Rowing)	
16	BabluMandal	9734655495	Bangitola G.P.	Country boat(Rowing)	
17	Krishna Mandal	9733221992	Bangitola G.P.	Country boat(Rowing)	

Kalaichak-III Development Block

Sl No.	Name of Boat Owner	Name of GP	Contact no.
1	TashiruddinSk	p/sovapur	9083345253
2	Abdul Alim	P/sovapur	9734619535
3	Inalhaque	P/sovapur	8768374510
4	Bakkarsekh	p/sovapur	9153263569
5	Sanjay mondal	p/sovapur	9064727415
6	Shibumondal	p/sovapur	6295253802
7	ElahiSk	P.Sovapur	9775272061
8	Robiulhoque	P.Sovapur	8328794364
9	Abdul Sekh	P.Sovapur	8768030577
10	Azad sk	P.Sovapur	7319126031
11	Yusuf Ali `	p/sovapur	9775067215
12	Ramgati Chowdhury	p/sovapur	7797658896
13	Nandagopal Chowdhury	p/sovapur	7797429927
14	Raju Chowdhurya	p/sovapur	9735591663
15	Abu Kalam	p/sovapur	9732430218
15	Ashu Chowdhury	p/sovapur	8967772822
16	DilwarSk	Birnagar-I	9735070587
17	SikimSk	Birnagar-I	9735736170
18	AnjarulSk	Birnagar-I	9734990646
19	AlamgirSk	Birnagar-I	9734963011
20	RabiulSk	Birnagar-I	9734992198
21	DoulatSk	Birnagar-I	7797240679
22	RabiulSk	Birnagar-II	84369040679
23	KuddusSk	Birnagar-II	9564449967
24	SenaulSk	Birnagar-II	9734942915
25	IliasSk	Birnagar-II	8001251391

Bamongola Development Block

Sl. No.	Name og Majhi	Name of Ghat	Name of River	Contact No.
1	Kartik Biswas	Kadubari Rangamati Ferry Ghat	Tangan	8670213046
2	Bimal Roy	Dakatpukur Ferry Ghat	Tangan	9733232175
3	Jitu Hemram	Chhotopathari Ferry Ghat	Hariya	8145572219
4	Ananta Mandal	Machua Ferry Ghat	Hariya	8158835606
5	Tafijul Sekh	Samsabad Ferry Ghat	Brahamani	9647701655
6	Hepdul Sekh	Shibdangi Ferry Ghat	Brahamani	
7	Balai Roy	Dharmadanga Ferry Ghat	Tangan	8167520083
8	Nakul Mandal	Parhabinagar Ferry Ghat	Tangan	7872836155
9	Tapas Bairagi	Thangbhanga Ferry Ghat	Tangan	6295458965
10	Juran Mandal	Bhangachura Ferry Ghat	Tangan	9382057328
11	Mangal Soren	Shiltani Ferry Ghal	Hariya	9647356865
12	Tarapada Tarafdar	Kathuadanga Ferry Ghat	Tangan	8001753272
13	Nepal Biswas	Ashrampur Kali Ferry Ghat	Hariya	8348557906

Englishbazar Development Block

Sl No	Name of Boatman	Mobile No.
1	SajiruddinSabji	8145845568
2	KajilSabji	7797989537
3	Hiralal Chowdhury	9647702111
4	Mohilal Chowdhury	9932370637
5	Gobinda Chowdhury	7063524731
6	YunusSk	9932999643
7	Abdul Motin	9851386802
8	Harunol Rashid	7031657833
9	FarjanSk	9933365001
10	Dinesh Mandal	9733032834

Old Malda Development Block

NAME OF G.P.	NAME OF THE BOAT OWNERS	NUMBER OF BOATS	CONTACT
Jatradanga	Mustakhin Sekh	1	7319032440
	Ali Zinnatul	1	8967090873
	Khursed Sekh	1	7479039256
	Firojuddin	1	7478190293
Mahishbathani	Hassan Ali,S/O-Jalaluddin [Balarampur Village]	1	9002895607
	Abdul Salam [Borkol Budhiya Village]	1	8116385426
	Harun al Rashid [Mahishbathani Ferry]	1	8436404877
Sahapur	Sudev Haldar	1	9635860362
	Ananda Rajbanshi	1	7872953040
Muchia	Bittu Das[Charlaxmipur]	1	8759843952
	Nirmal Das[Charlaxmipur]	1	7478135362
Mangalbari	Ziaruddin,S/O-Jamiruddin	1	9749947711
	Salam,S/O-Jamiruddin	1	9749947711
	Rejaul	2	8927581594

Old Malda Municipality

Ward No.	Name of the Boat Owners	Number of Boats	Contact
1.	Madan haldar	01	8906233190
2.	Jogen haldar	01	7063358569
3.	Mridanga Haldar	01	9654741327

List of Heritage Building or Sites in Malda District

Building

1. Baroduari Mosque
2. Kadam Rasool Mosque
3. Lottan Mosque
4. Adina Masjid
5. Eklakhi Mausoleum
6. Qutab Shahi Mosque

Site

1. Ramkeli
2. Dakhil Darwaza
3. Foroz Minar
4. Lukochiri Gate
5. Jahura Kali Temple
6. Adina deer Park
7. Adina Eco Park
8. Jagjivanpur Bouddha Bihar

HARISHCHANDRAPUR-I DEVELOPMENT BLOCK

HAZARD, VULNERABILITY, CAPACITY & RISK ASSESSMENT (HVCRA)

The Government of WB recognizes that disasters can either be man-made, natural or even arising out of technological causes. A robust Disaster Management policy must therefore provide, plan and prepare for all types of hazards and disasters that may be reasonably.

Vulnerable Flood prone Area	Generally the following vulnerable areas the unprotected are affected in the event the mitigation	
	Kushida GP	Bijhot, Dakhol, Hossainpur, Rajol, Owari, Rampur, Kapaichandi, Kotol. Vatol, Sekpara etc.
	Boroi GP	Simla, Nandibati, Mahespur, Boroi, Chopal, Bidhanpur, Swarupganj etc.
	Tulshihata GP	Bhabanipur, Islampur, Rampur, Chandipur, Kosturiya, Baznath pur, Bangrua etc.
	Harishchandrapur GP	Harishchandrapur, Tetulbari, Kalipukur, totally flooded by the River water.

VULNERABLE AREAS NAME OF GP EMBANKMENT, ROAD ETC.

Sl. No.	Name of GP	Name of village sansad No.
1	Kushida	Bijhot, Dakhol, Owari, Hossainpur, Nasarpur, Laxmipur, Kapaichandi
2	Boroi	Gohila, Boroi, Pathanpara, Rampur
3	Rashidabad	Saldah, Ramshimol

CONTROL ROOM AND CRISIS MANAGEMENT TEAM WITH CONTACT NO.

Government Departments must ensure adequate assistance to Department of Disaster Management, the district administration and local authorities for activities in this phase. These Departments should ensure their active co-operation in setting up communication centers, drawing up contingency plans, assisting in capacity building, developing plans, gathering data, and identifying and training appropriate personnel, under the overall supervision of WBSDMA. The Department of Civil Defense will prepare their own plan as per Rules of Business in respect of rescue operation, cluster approach to minimize response time, training and disaster preparedness (CBDP & capacity building).

Sl. No.	Name of Officer/Official	Designation	Contact No.
1	Anirban Basu, WBCS (Exe.)	BDO	7719360731
2	Madhurima Chakraborty	Joint BDO	9073938567
3	Amin Murmu	Joint BDO	9635385126
4	Binoy Bhushan Saha	AEO/BDMO In Charge	9733157249
5	Dilip Roy	CCT/PS	8918502414
6	Bishnu Chandra Mandal	LDC	9851343525
7	Md Jalal	Relief Clerk in charge	9775434842

Name of the Pradhan	Contact Number
1. Pradhan, Boro Gram Panchayat, Sonamani Saha	8016278432
2. Pradhan, Bhingole Gram Panchayat, Biman Bihari Basak	9733371405
3. Pradhan, Harishchandrapur Gram Panchayat, Rishba Khatun	7719225335
4. Pradhan, Kushida Gram Panchayat, Akhtari Khatun	9647806910
5. Pradhan, Mahendrapur Gram Panchayat, Joynab Nesha	8145513420
6. Pradhan, Rashidabad Gram Panchayat, Pushpa Rabi Das	9064936883
7. Pradhan, Tulsihatta Gram Panchayat, Shakuntala Singh	8116569866

CIVIL DEFENSE PERSONNEL TO BE DEPLOYED FOR SEARCH & RESCUE OPERATION WITH CONTACT NO.

Sl. No.	Name of the Civil Defense	Contact No.
1	Nirmal Karmakar	9851490047
2	Rasidul Islam	8145082769
3	Saidul Islam	9800835064

COUNTRY BOAT & MECHANISM BOAT DEPLOYMENT DETAIL WITH AUTHENTIC CONTACT NO & NAME OF BOATMAN

Sl. No.	Name	Father name	Address	Contact no
1	Noor md	Sk Ainal	Rashidpur	9647205345
2	Sk Idul	Sk Tajul	Rashidpur	9647205345
3	Sk Rajjak	Noor Md	Rashidpur	9535215535
4	Jaherul	Afjal	D Saldah	9733118278
5	Manjur	Safiruddin	D Saldah	964770296
6	Mafijul Hoque	Basiruddin	Ranipura	8609336002

MECHANISM OF DISSEMINATION OF WARNING MESSAGE BY E-MAIL MOBILE NO. WHATSAPP ETC.

Sl. No.	Email Id	Whatsapp	Contact No.
1	harishchandrapur1@gmail.com	7719360731	7719360731

NAME & LOCATION OF HELIPAD WITH LONG & LAT

Name of Helipad	Location	Longitude	Latitude	Remarks
Kushida Hat Maidan	Kushida Hatkhola	86.832124	24.417584	

PLAN TO THE CO-ORDINATE WITH PHE FOR SAFE DRINKING WATER

Sl. No.	Name of Co-Ordinator	Contact no.
1	Subrata Majumdar(SAE)	9434198047

EMERGENCY STORAGE OF LIFESAVING DRUG STOCK OF ANT VENOM

Sl. No.	Name of diagnostic Clinic	Contact no	Diagnostic facilities available
1	Kushida Diagnostic Centre	9733161121	Blood, Urine, X-Ray

EMERGENCY STORAGE OF LIFESAVING DRUGS, STOCK ANTIVENOM

Sl. No.	Name of Institution	Contact no.
1	Kushida BPHC	9733161121

AMBULANCE WITH CONTACT NO.

Sl. No.	Name of Ambulance Owner	Contact No.
1	Shymal Choudhury	973334970
2	Ashok Mandal	9593932853
3	Akhtar Mandal	9733354363
4	Asha Das	7882491088
5	Rakesh Das	8348852216

List of the ambulance:

Sl No.	Name of Ambulance Owner	Ambulance No.	Contact No.
1	Chanchal	WB/65B/0574	9002332275/9609736869

List of the Drug shops:

Sl. No.	Name of drug house	Contact No.
1.	Janata Pharmacy	9932921682
2.	Shree Krishna Drug Home	7501651454
3.	Narayane Seva Sadan	9933682382

List of Vehicles:

Sl. No.	Name of owner of other Vehicles(to be used at the time of disaster)	Type of such vehicle. E. Car, bus, trekker, JCB	Vehicle No.	Contact No.
1.	Mobarak	JCB	WB 830354	9733146325
2.	Abul Hossen	JCB		7872980321

List of Doctors and RMPS:

Sl. No.	Name of Doctors available in the area	Contact No.	Specialized field
1.	Dr. Nirmal Das	9733206277	Not specified(RMP)
2.	Dr. Sohel mamud	8967090633	Not specified(RMP)
3.	Dr. Manowr Alam Didar	9932412603	Not specified(RMP)
4.	Dr. Suarshan Thokdar	9933398079	Not specified(RMP)

List of NGO/Volunteers

Sl. No.	Name of Volunteers/NGO	Contact No.	Specialized field
1.	Harishchandrapur Polly Unnowan Samity	8944982906	

Other Important No.:

Sl. No.	Name of office i.e. fire brigade, Police station, BMO(H)/ Pradhans of Gram Panchayat/ Savapati of Panchayat samiti etc.	Contact No.	Remarks
1.	H.C. Pur Fire Station	03513-244121	
2.	H.C. Pur Police Station	7797996906/9083270315	
3.	BMOH	8348102855	
4.	Sabhapati HC Pur	9732100276/9733240933	
5.	(Prodhan, Boroi)	8016278432	
6.	(Prodhan, Bhingole)	9733371405	
7.	(Prodhan, H.C.Pur)	8637045480	
8.	(Prodhan, Kushida)	7980426984	
9.	(Prodhan, Mahendrapur)	8145513420	
10.	(Prodhan, Rashidabad)	9064936883	
11.	(Prodhan, Tulshihatta)	8116569866/6295260866	

HARISHCHANDRAPUR-II DEVELOPMENT BLOCK

Medical Institution & Hospital:-

Sl no	Name of Institution	Contact No.	Bed Capacity	No. of stretchers available	No. of doctors available	No. of para-medical staffs available
1	Mashalda Bazar BPHC	98043-84057	30	2	4	3
2	Bhaluka PHC	95647-66808	10	1	2	0
3	Hardamnagar PHC	97334-74735	0	0	1	0

Sl.No	Name of diagnostic clinics	Contract No	Diagnostic facilities available
1	Shifa diagnostic centre (Kumedpur	9733234157	Blood ,urine etc.

Control Room & Crisis Management Team with Contact No.

Sl No	Name of Officer / Official	Designation	Contact No
1	Pritam Saha	BDO	9434738492
2	Monoj Kumar Mohali	JT BDO	9830782587
3	PURNA CH SAHA	BDMO –in-Charge	9734007964
4	LAKSHMI KANTA MANDAL	Relief Clerk in-Charge	7797828034
5	PURUSUTTAM RAJAK	UDC (C.C)	7407429787

Civil De fence Personnel to be deployed for search & rescue operation with contact no. & Deployment.

Sl No	Name of Civil Defence Person	Contact No
1	SANTOSH KARMAKAR	97330789080
2	ASHISH PASWAN	8670510415
3	MD FIROJ ALI	9153253909
4	ANIMESH DAS	9734129449
5	BAPI KUMAR DAS	9635101868

Important Telephone No. & Address of Resource persons of NGO, CBO & Social Worker.

SL No-	Name and address of volunteers/NGO	Contract no
1	Uttar Kumedpur jyotirmoy Dev.society	8371918718,9733473918
2	Social worker(sudipto)	9734910885

DISASTER MANAGEMENT PLAN : CHANCHAL-I DEV BLOCK

Control Room & Crisis Management Team with Contact no:

Block Control Room			
Name	Designation	Contact no.	Land Phone
Mohan Verma	Jt. BDO	9851434383	
Kamal Prasad Ram	BWO	9733388929	
Pralay Sankar Biswas	BIO	9134876060	
Crisis Management Team			Gr. D (Coll. Relif)
Name	Designation	Contact no.	
Masud Karim Ansari	SI, Kharba-I Circle	8967570727	
Soumitra Sarkar	SI, Chanchal Circle	9593626597	
Obaidulla Ahamed Chowdhury	Sabhapati	9775427117	
Rohini Kanta Saha	Saha-Savapati	9735048096	
MD. MANIRUL ISLAM	DY. SECY.	7548937255	
SREEKANTA MISRA	CC (UDC)	9641555500	
BIPLAB SAHA	UDC (BP)	9609802809	
SHAMBHU CHOWDHURY	PEON (PS)	9932927116	
AMAR SING	C.C.T.(R.W.P.)	9734127398	
ABU BAKKAR SIDDIK	A.O.	9933641368	
ARCHISHMAN ADHIKARY	SEO	9832080637	
Bikash Chowdhury			

Gram Control Room & Co-Ordination Cell of Mahanandapur Gram Panchayat		
Name	Designation	Contact no.
Gopal Chowdhury	Mahanandarur Prodhan	9002059659
Mahabul Alam	MahanandapurUpa Prodhan	8145974741
Faiyaz Alam	G.P. Member	9641871265
Matiur Alam khan	P.S. Member	8101686111
Rakibuddin Ahamed	Secretary	9800489925
Biswajit Majumdar	NS	7407927370
Ataur Rahaman	VLE	9733121565
Samar Ch Pal	Sahayak	9002831920
Gram Control Room & Co-Ordination Cell of Bhagabanpur Gram Panchayat		
Name	Designation	Contact no.
Sabina Pervin	Bhagabanpur Prodhan	9958450623
Saiyad Arif Ali	Upa Prodhan	9733249373
Mirza Begam	P.S. Member	9734937115

Mithun Pal	NS	9851413516
Rafikul Islam	Secretary	9593792293
Gram Control Room & Co-Ordination Cell of Mokdampur Gram Panchayat		
Name	Designation	Contact no.
Sahadeb Chandra Mandal	Mokdampur Prodhan	9679210082
Mustaq Alam	Upa Prodhan	9563241042
Asma Bibi	P.S. Member	9733133685
Jagadish Prosad Saha	Secretary	9609959091
Md. Mohasin Mir	NS	9633403512
Md. Ikbal Hossain	Sahayak	8016928786
Chhandam Thokdar	GRS	9932073446
Mansur Alam	VLE	9647801466

Gram Control Room & Co-Ordination Cell of Alihanda Gram Panchayat		
Name	Designation	Contact no.
Manowara	Prodhan	9679045132
Md. Berek Ali	Up Prodhan	9083035560
Md . Helal	PS Member	8158078246
Jannatun khatun	PS Member	9933527462
Suprakash Mandal	Sahayak	9734937028
Md.Abbas Ali	Sahayak	9563209331
Dilip Rajak	N S	9733430013
Sajjad Alam	G R S	8170971391
Dipu ch. Das	G P K	7602914209
Aboul Kalam Azad	J S	7407877520

Gram Control Room & Co-Ordination Cell of Chanchal Gram Panchayat		
Name	Designation	Contact no.
Ajmira Khatun	Prodhan	7029539282
Utpal Talukdar	Up Prodhan	9733393736
Tasmin Jahan	PS Member	9647738813
Md Muddassar Hossain	EA	9733098087
Abdul Matin	NS	9635408403
Gopal Chandra Rajbansi	Secretary	9933454852
Amar Bhusan Saha	Sahayak	7001266237
Dibyendu Saha Roy	GRS	9800523775
Ariupmoy Sarkar (VLE)	VLE	8101495656
Amitesh Pande	Member (P.S.)	9614010125

Gram Control Room & Co-Ordination Cell of Motiharpur Gram Panchayat		
Name	Designation	Contact no.
Popi Das	Pradhan	9735980022
Mst. Pinki Khatun	Upa Prodhan	7063228337
Hasan Ali	PS Member	9932169123

Md. Imran Ali	E.A.	9593074696
Aaraf Hossain	Secretary	9734163107
Munjur Alam	Sayahak	9933684220
Kanai Mahato	Sahayak	7602726791
Abdul Salam	GRS	8759306501
Manas Kumar Dey	GPk	8001308106
Najumul Hoque	J.S.	9002442889
Gram Control Room & Co-Ordination Cell Kharba Gram Panchayat		
Name	Designation	Contact no.
Parvina Khatun	Pradhan	9832566743
Saimuddin	Upa Pradhan	9641047791
Sahanaj Alam	PS Member	9932737580
Saida Sultana	PS Member	7384450594
Bishnu kumar Das	EA	9609772024
Kajal Basak	Secretary	8167726733
Abhimannu Sarkar	NS	9775141144
Bapi Das	VLE	7063504705
Gram Control Room & Co-Ordination Cell Kaligram Gram Panchayat		
Name	Designation	Contact no.
Rejaul Khan	Pradhan	9851474781
Achin Das	Upa Pradhan	9563521748
Dolon Roy Choudhury	PS Member	9933359150
Adil Hossain	PS Member	9732583384
Tapas Halder	N.S	7407892230
Prasun Kumar Das	GP Karmee	9547810794

Flood Cell controlled by Malda irrigation Division opens from 1st June 2018 to end of oct,2018 and Daily basis river gauge reading taken at 6 a.m.12-00Noon to,6:30..pm.and the same data circulated through whatsapp Group.

Flood Cell No 035122-53939 (Working hours 6 am.to 10 P.m.) For Crisis Management

Sl No	Name	Designation	Contact No
1.	Biswajit Barman	Sub: Divisional Officer,Mahananda mbankment Sub: II H.C Pur Malda	7001746306
2.	Somnath Nanda	Junior Engineer(Head quarter)	9932215618
3	Pradip Kumar Jana	Junior Engineer(Asapur)	9732973928

Important Telephone number of Line Department:

Sl no	Name	Designation	Contact no
1	Dipankar Deb	ADA	9749071197
2	Prodip kr. Jana	Junior Engg, Mahan. Sub-II, HCPur (Ashapur)	9732973928
3	Dr. Soma Das (Saha)	BLDO	03512-252103
4	IC, Chanchal	IC, Chanchal	03513-252256

5	BMOH	BMOH, Chanchal Sup. Spe. Hospital	03513-252375
6	Fire Brigade		03513-2525101
7	BL&RO		03513-252878
8	Station Manager, Chanchal Electricity		7430092382
9	Chanchal PHE, Chanchal		9775800973
10	Chanchal rotary Club, Chanchal		9564457696
11	Merchant Association, Chanchal		9434053429
12	CDPO		03513-252765

Civil defense Personnel to be deployed for search & rescue operation:

Name	Address	Contact no.	Land Phone
Safikul Islam	Mulaibari	7407947041	
Mamon Ali Reja	Mulai bari	8436326763	

Mechanism of dissemination of warning message by email, mobile, whatsapp:

Name	Address	Contact no	Land Phone
Mohan Verma	Jt. BDO	9851434383	
Bikash Chowdhury	Gr. D (Coll. Relif)	9832536157	
Office email bdo.chanchol1@gmail.com			

High Land details :-

L N O	NAME OF EARMARKED HIGH LAND FOR RESCUE PURPOSE	NAME OF GP	CAPACITY TO SHELTER PERSON IN NO	LATITUDE AND LONGITUDE OF THIS PLACE	NAME OF VILLAGE FOR WHICH IT IS EARMARKED FOR SHELTER
	MAHANANDA MASTER PLAN	KHARBA	2000 NOS	25°028480" 88°005936"	BHABANIPUR, SANDALPUR, KHIDIRPUR, SRIPATIPUR,DIYAGANJ,SHAKTI HAR, DUMRAHAL, TARAPUR, UDAYGANJ,
	KHARBA HN AGRIL HIGH SCHOOL	KHARBA	200 NOS	25°4226453 3" 88°0794902 2"	DURGAPUR, GOPALPUR,KAJLADHA, KISMPUR, KENDUE
	SHAKTI HAR ASHAPUR PRIMARY SCHOOL	KHARBA	100 NOS	25°4239867 8" 88°0879238 9"	RANIPUR,NICHLAMARI, MAHADEBPUR, SHAKTIHAR ASHAPUR
	Gram Panchayat Office building	MAKDAMPUR	100	25°26'31.48" 88°00'24.52"	Nadishik,Pirojabad,Paikpara
	Shitalpur Mobarakpur H.S School	MAKDAMPUR	250	25°26'31.17" 87°59'27.88"	P. Gouria,Mobarakpur,Bagjana,Uttar Basantapur

	Ismailpur Jr. High School	MAKDAMPUR	100	25°27'19.36" 88°01'33.34"	Hazatpur, Ismailpur, Aswinpur, Nichitpur
	Serpur Mokdampur Jr. High school	MAKDAMPUR	75	25°27'29.52" 87°59'50.73"	Serpur, Gouria, Makdampur, Diyara Chanayanpur, Uttar Gopalpur
	Galimpur Bandh	Motiharpur	300	25°23.389" 88°05.656"	Galimpur, Adhserpur, Narosinghapur, Malcha
	Doriyapur DIB High School	Motiharpur	500	25°23.389" 88°04.583"	Doriapur, Immapur, Sorarai, Borombal, Kathalmari, Dighabasatpur, Kaliyapara, Pouria
0	Santoshpur Katlamari High Madrasha	Motiharpur	250	25°23.251" 88°04.388"	Santoshpur, Kusmai, Bankipur
1	Basantapur Kanchantola High Madrasha	Motiharpur	200	25°22.454" 88°02.541"	Bamua, Dhumasangi, Motiharpur, Sankorkola, Durgapur
2	Mahana ndapur Band	Mahana ndapur	100	25°494432" 88°005936" 25°484836" 88°026434"	Sawrupganj, Mayapur, Bachbari, Palashi, Noator, Mahalderpara, Mahanandapur, Hariyan, Daibhatta, Jagannathpur, Ratot, Sankola
3	Nayatoli Mahanandapur High Madrasha	Mahana ndapur	200	25°48258889" 88°01868611"	Bistupur, Naidha, Jasuya, Jahirkha, Nimgachhi, Dhanjana
4	D.P. Mallikpara High School	Mahana ndapur	200	25°48461667" 88°02634167"	Mallikpara, Dakshinpaka, Kaliyapara
5	Chanchal R.D. Girls High School	Chanchal	200	25°39064200" 88°0097099"	Ranikamat, Khelenpur, Sihipur, Umarpur,
6	Birashtoli High School	Chanchal	200	25°35828900" 88°01973300"	Gilabari, Srirampur, Kashipur, Sanjib, Paharpur, Dakshin Sahar
7	Thahaghati High Madrasha	Alihand	200	25°41438056" 88°01266389"	Alihanda, Sitalpur, Suratpur, Balidhaga, Khurial, Mahammatpur,
8	Hatinda Sibar MSK	Alihand	100	25°41779722" 87°99335278"	Hatinda, Nayatoli, Rajnagar, Mastipara,
9	Kaligram High School	Kaligram	250	25°39285833" 88°03266111"	Chandigachhi, Ramnagar, Khanpara, Nurganj
0	Kaligram Girls High School	Kaligram	200	25°39359467" 87°02916522"	Mulaibari, Bhagobatipur, Kaligram, Pransagar
1	Arbora High School	Bhagab anpur	250	25°44129444" 88°04164167"	Nayanpur, Baguj, Purba Nichitpur,
2	Ramdebpur Jr. High School	Bhagab anpur	150	25°46903333" 88°07582500"	Ramdebpur, Jotchandi, Bheba, Kaliganj, Serbour

Medical facilities and contingency plan

SI No	Name of Hospital	Contact no	Bed Capacity	Structures	No. Doctors Available	No. of para medical staffs available
1.	Chanchal Super Hospital	Dr. Pradip Kumar Barui 8759517738	300	30	33	60
2	Kharba PHC	Dr. Debashis Das 9434381207	10	2	1	Nil
3	Nadishik PHC	Sujit Mandal 9434422584	Nil	Nil	1	Nil

SI No	Name of Hospital	Contact no	Bed Capacity	Structures	No. Doctors Available	No. of para medical staffs available
1.	Dishari Nurshing Home	8170041116	25	4	3	8

SI No.	Name of Diagnostic Centres	Contact No,	Diagnostic Facilities, Available
1.	Nirnoy Diagnostic Centre	9434040312	Blood Test ECGE, XRAY etc.
2.	Sebayan Diagnostic Centre	7797859939	Blood Test ECGE, XRAY etc
3	Green Land Diagnostic Centre	9635614270	Blood Test ECGE, XRAY etc

SI No	Drug House	Contact No.	Remark
1	Parbati Medical Stores	9851471872	
2	Chanchal Medical Hall	03513252237	
3	Cosmos Drug House	8926089708	
4	Ganesh Medical Hall	9474161795	
5	Rahima Medical Shop	7430983903	
6	Roy Medical Stores	Nil	
7	Shova Medical Hall	9932100728	
8	Bose Pharmacy	7432981749	
9	Karmakar Medical Stores	9153397566	
10	Rainbow Medical Stores	9735905634	
11	Renuka Drug House	9933684338	
12	Chanchal Medical Centre	9434423008	
13	Dadabhai Medical Centre	9933991169	

List of Doctors Available in Area

SI No	Doctors Name	Department/Ward	Registration No	Mobile No
1	Dr. Pradip Kr. Barui	Supar	65809	87595177738

2	Dr. Soumen Sou	DCH		9734529552
3	Dr. Satuajit SAha	EMO	50747	9434354920
4	DrAlok Kr Paul	Gyne		943455778
5	Sandip Sarkar	Emo		7699019627
6	Jaba Das	Microbiology		9434511048
7	Dr. Dipanjan Das	HDU	Wbmc68427	8902051838
8	Dr.Saiyad Amirul Mannan	Paediatrics	Wbmc161066	987440981
9	Dr Tapas Chakrabarti	Anesthesia		9434036741
10	Dr. Haradhan Santra	HDU	Wbmc1168147	9830748971`
11	Dr.Souvik Basu	Anesthaia	Wbmc56474	8697242248
12	Snndip Kr. Haldar	HDU		97751717103
13	Dr Sankar Roy	EMO		9232699034
14	Sachin Roy	EMO		6163196930
15	Dr.Prabir Debnath	OPHTHALAMOL OGY	45042	6163560406
16	Mira Sardar	SNCU		9647682249
17	Bidhan Mandal	HDU	70299WBMC	9903017783
18	Dr. Dipika Mandal	EMO	50638	943430787
19	Pradip KrSantra	EMO	54513	9434105100
20	Dr. Sarmistha Dey Ghosh	MEDICAL OFFICER		
21	Biplab Pratihar	EMO		9433111800
22	Sudip Mandall	EMO		
23	Surojit Gayen	DENTAL	2744A	9432815086
24	Sanjib Kr. Dubey	DENTAL	3117A	9903884639
25	Dr.Sahana Nasmi	DENTAL	3287A	9051048165
26	Mihir Adhokari	MEDICINE	56732WBMC	97755623810
27	Goutam Mukerjee	MEDICINE		
28	Merina Begam	EMO	67030WBMC	8944043662

Important Telephone No.& Address of Resource persons of NGO, CBO, & Social Worker

Chanchal GP		
1	ChildLine Chanchal	
2	Vivekananda Sriti Somsad Chanchal	
3	Blue Star Club, Chanchal	
4	North Malda human Cultural Society	9932932860
Kharba GP		
1	Mulaibari Jiban Bikash Society	9700440246
2	Gopalpur SKUS Society	9733027844
Alihanda G.P.		
1	Malda Cristal Welfare Society	9733430473
Mokdampur G.P.		
1	Haripur Ashwinpur Welfare Society	7872202021

Bhagabanpur GP		
1	Arbora Biplabi Club	9733188081
2	Harishchandra Welfare Society	9733482651
Kaligram G.P.		
1	DNK Yuth Club at Dhuliabari	9669067980
2	Durbasa Club at Bogchara	9635375473
3	Chanchal Irrigation & labour Contract Society	9733121090
Motiharpur GP		
1	Jakir Hossain	9002913328
2	Mahobubul Haque	9593266175
3	Mojibur Rahaman	9593947057
4	Gopalpur SKUS	9733027844
5	Mulaibari Jiban Bikash Society	9733440246
Mahanandapur		
1	Dighi Jiban Bikash Society	9832305967
2	Shushobhan Saha	9733467918
3	Chiranjib Sarkar	9733176637
4	Gopal Pramanik	9800162920
5	Mojaker Hossain	9734032251

.Chanchal Sadar Hospital and Kharba, Nadishik BPHC has lifesaving Drugs.

Sl No	Name of Ambulance Owner	Registration no	Contact no,
1.	Shyamal Ch., Das	Wb8/0719	9733174678
2	Hasin Mahamad	Wb19/d2912	9007224334
3	Hasin Mahamad	Wb65a/3283	9007224334
4	Kaliganj Udayganj Nabajagorani	Wb657370	9734087921
5	Md. Abul Kashem	Wb83034	876883547
6	Md Samjujoha	Wb830241	9083101765
7	Md Munjur Alam	Wb65c/1465	9647806698
8	Ms Nuerey Alam Sarkar	Wb659298	9734163372
9	MulaiBari Jiban Bilkas Socity	Wb65/9112	9733440246
10	MulaiBari Jiban Bilkas Socity	Wb65/9107	9733440246
11	Ujjal Ghose	Wb65/4241	9932336414
11	Ujjal Ghose	Wb65/c0163	9932336414
11	Ujjal Ghose	Wb65/b6634	9932336414
11	Ujjal Ghose	Wb65/a5448	9932336414
15	Swapan Pramanik	Wb65b9784	9563253714
16	Matiur Rahaman	Wb76A/2615	9593220768
17	Pulak Das	Wb 73/7421	9679416091
18	Santosh Saha	Wb 73/5669	9932210694
19	Saiyad Ferdous Alam	Wb 655562	9735947474
20	Sarif Sekh	Wb 71-9209`	9593759215
21	Badrul Hossain	Wb65b-0125	9734195082
22	Badrul Hossain	Wb65b-8308	9734195082
23	Pappu Roy	Wb65tc 377	7076075197

Disaster Management PLAN 2019-20 of Chanchal-II Block Development, Malatipur, Malda.

Block has been completely surrounded by Harishchandrapur-II Dev. Block and Ratua-I Dev. Block is at the south eastern side of the Block. The area of water ways is 1799 Hector in the entire Block.

01 . Block Profile:

Total No. of G.P	07 (Seven)
Total No. of Mouza	92
Total Area of the Block	205.22 Sq. K.M
No. of River	04 (Mahananda, Sui, Baromasiya, Mora Mahananda)
Population (as per 2011 census)	2,05,333
Male Population	1,05,374
Female Population	99,959
No of Household (Kancha bari)	18,802
No. of B.P.H.C	01 (Malatipur)
No of Health Sub-Centre	25
No. of High School	13
No. of Jr. High School	06
No. of Primary School	86
No. of M.S.K.	08
No. of S.S.K.	46
No. of I.C.D.S. Center	236
Name of the Police Station	Chanchal
No & Name of the FIRE BRIGADE	01, Paharpur, Chanchal (Nearest)

her Important No. : Sl. No.	Name of Office i.e. fire brigade, Police station, BMO(H) / Pradhans of Gram Panchayat/ Savapati of Panchayat Samiti etc.	Conta ct No.	Remarks
1	BDO	7719360734	
2	Jt.BDO	9800261076	
3	SABHAPATI	8250234254	
4	SAHA-SABHAPATI	9609809392	
5	KARMADHYAKSHA OF TRAN	9800524184	
6	BMOH	9474379287	
7	ADA	9609847780	
8	BLDO	8016232189	
9	BL&LRO	9593466532	
10	I/C POLICE STATION	9083270314	
11	PRODHAN BHAKRI GP	9851406526	
12	SECY. BHAKRI G.P.	9734163220	
13	PRODHAN GOURHAND	9563405860	
14	SECY. GOURHAND	9126439151	
15	PRODHAN KSHEMPUR	9775853821	
16	SECY. KSHEMPUR	9733531350	
17	PRODHAN DHANGARA	9733234024	
18	SECY. DHANGARA	9733354147	
19	PRODHAN MALATIPUR	9733280399	

20	SECY. MALATIPUR	9800255855	
21	PRODHAN JALALPUR	9733733735	
22	SECY. JALALPUR	9647725281	
23	PRODHAN CHANDRAPARA UPA PRODHAN CHANDRAPARA	9647838533/7477493129 9733297570	
24	SECY. CHANDRAPARA G.P.	8145837646	

Block Disaster Management Plan

Ratua –I Development Block

Chapter – 1

Introduction:

Natural Disasters continue to strike without notice and are perceived to be on the increase in their magnitude, complexity, frequency and economic impact. These hazards pose threat to people, infrastructures and economic assets and assume disastrous proportions when they occur in areas of dense human habitations.

Ratua-1 Development Block is situated at the right side of River Fulahar, Ganga. Geographical area of Ratua-1 Block is 139.5 sq K.M. consisting of 10 Gram Panchayats covering 101 mouzas, 184 Village and 167 Gram Sansad. The total population as per 2011 census is 2,75,334.

It appears from the previous record that Flood is a common phenomenon and it occurs every year specially in two unprotected Gram Panchayats namely Belaimari and Mahanandatola. In the year 2009, due to breakage of Bhaluka Bandh, in 2010 due to overflow of Fulohar River, 2011 flood and 2017 also occurred devastating flood. Out of ten Gram Panchayats, seven nos. of Gram Panchayats were completely sub marooned in the year 2011 and 2017. In the year of 2017, 29,500 families and 118000 people were affected, 8 persons were died due to snake bite, electric shock and drowning. In the year 2013 & 2016 due to overflow of Fulohar River flood occurred in two Gram Panchayats namely Belaimari and Mahanandatola. Recurringly every year this problem creates a disruption of normal life, loss of property and crops in almost 10 G.Ps.

This plan has been prepared in anticipation of mitigating and preparedness to reduce human misery in disasters like Flood, Cyclone, Water logging, Fire, Lightening, accident or house collapse etc. Action plans at Gram Sansad level and G.P level are prepared for fighting the disasters.

I hope this plan will be useful to the officials of line department and Panchayat functionaries of this Block at the time of crisis during natural calamity. It is requested to all concerned to extend their hands to helpless and distressed people at the time of crisis.

Shri Sarwar Ali, WBCS (exe.)
Block Development Officer
Ratua-I Development Block,

GENERAL INFORMATION

LAND USE (in acres)	
Net areas under Cultivation (Acres)	29312.66
Area under pasture orchard etc. (Acres)	2,722
Cultivable Waste Land (Acres)	382
Home Stead Land (Acres)	2,451
Forest Land (Acres)	Nil
Residual area (if any)	72
Area in which more than one crop is grown (Acres)	10,600
Area of Vested Land	3,879.33
Amount of land distributed	3,093.58
No. of Assignee	6,728
AGRICULTURE AND ALLIED ACTIVITIES	
Major cropping indifferent seasons (In Hector) :	
Boro Paddy -	4000
Wheat -	3200
Barly -	1350
Gram -	1350
Rabi Pulses -	1450
Arhor -	180
Mustared -	2200
Maize	1300
Autumn Rice -	3000
Winter Rice -	6350
Jute -	3000
No. of Huts/ Regulated Markets	14
ANIMAL HUSBANDRY	
No. of Milk Cows	22569
No. of Plough Animal	36250
No. of Goats	65910
No. of Poultry Birds	94688
FOREST	
a) Name of Forest product (if any)	Nil
b) Approximate Annual production (Unit to be defined)	Nil
c) Area covered by social forestry (in acres)	50
d) No. of beneficiaries	

1) Schedule Caste	375	
2) Schedule Tribe	212	
VETERINARY SERVICES		
No. of Veterinary Hospital/ Dispensary	2	
No. of Veterinary Surgeons	2	
No. of A.I.Centre	4	
No. of Veterinary Aid Centres	2	
FISHERY		
Net Water Area(in hectre)	400	
Net Water area under effective pisciculture (in hectre)	250	
No. of persons engage in the profession	5000	
Approximate Annual Production in (Qtls)	3000	
IRRIGATION		
Net area under Irrigation (in Acres)	13,770	
Type of Facilities	No.	Area benefited
a) Canals	Nil	Nil
b) Tanks	97	250
c) R.L.Is.	31	4500
d) DTWs	18	2400
e) STWs	1250	6250
f) Others	10	370
INDUSTRY		
a) No. of units	45	
b) Type of Product	Manufacturing of washing Soap Detergent, Mustard Oil Mill, manufacturing of Gate & Grill,Steel Trunk, making of nylon Bag, Veneer, Tali manufacturing, manufacturing of Distil water etc.	
BASIC AMENITIES		
1) Drinking Water Supply		
a) No. of villages with spot sources	184	
b) No. of villages with pipe water supply	10	
2. EDUCATIONAL INSTITUTIONS		
a) No. of Primary Schools	117	
b) No. of Secondary Schools	8	
c) No. of H.S. Schools	1	
d) No. of College	Nil	
e) No of Rural Libraries	6	
f) No. of adult Education Centre	Nil	

g) No. of Non normal Education Centres	Nil
3. HEALTH FACILITIES	
a) No. of PHC	1
b) No. of beds	15
c) No. of SHCS	3
d) No. of beds	10
e) No. of SHCS without beds	2
f) No. of Medical Practitioners	
i) Allopath	4
ii) Homeopath	1
iii) Ayurvedic	Nil
4. POWAR	
No. of Mouzas	30
No. of pumps energised :	
R.L.I.	12
D.T.W.	17
5. PUCCA BUILDINGS	
a) No. of Community buildings	Nil
b) No. of Pry. School	36
c) No. of other educational institution	18
d) No. of dispensaries Health Centre	6
e) No. of Panchayat buildings	10
ROAD AND TRANSPORT	
a) Length of road (K.M.)	305 K.M.
b) Under PWD (Roads)	37 K.M.
c) Under Z.P.(Metalled)	Nil
d) Under Z.P. (Unmetalled)	0.50
e) No. of Ferry Service	6
f) No. of Bus routes	4
g) Nearest Rly. Station From Block H.Q.	Samsi Rly Stn.
h) Minimum distance from Rly. Station of village	0 K.M.
i) Maximum distance from Rly. Station of village	18 K.M.
OTHER FACILITIES	
i) No. of Post office	16
ii) No. of Bank Branches	9
iii) No. of Co- operative societies	45
iv) No. of Members in Co-operative societies	14885

GP wise Four-man Committee –

Block Level Disaster Management Committee 2020-21

Peoples' Representatives				
Sl. No.	Name of Representative of People / Govt. Officers	Designation	Portfolio	Contact No.
1	Abeda Begum	Sabhapati, Ratua-I Panchayat Samity	Chairperson	8001295526
2	Samar Mukherjee	M.L.A., 48 - Ratua L.A.	Member	9433107010
3	HAJERA BIBI	Karmadhyaksha, Shishu O Nari Unnayan, Janakalyan O Tran Sthayee Samity	Member	7478980458
4	KIRAN MAJHI	Prodhan, Mahanandatola GP	Member	9647607464
5	LUTFUR RAHAMAN	Prodhan, Bilaimari GP	Member	9564332079
6	BABY MONDAL	Prodhan, Kahala GP	Member	8327820560
7	PANKAJ MISHRA	Prodhan, Debipur GP	Member	7609930683
8	JUCIY SAHA (MONDAL)	Prodhan, Baharal GP	Member	9734040002
9	SK ALAMGIR REJA CHOWDHURY	Prodhan, Ratua GP	Member	9775235268
10	BIBI SETARA	Prodhan, Bhado GP	Member	9733476294
11	SHRABAN KUMAR DAS	Prodhan, Samsi GP	Member	9735335397
12	RABIUL	Prodhan, Chandmoni-I GP	Member	9733210741
13	JOSNARA KHATUN	Prodhan, Chandmoni-II GP	Member	9733434543
Block Officers				
1	Sarwar Ali	Block Development Officer, Ratua-I Development Block	Secretary	7719360735
2	Ratan Oraon	Block Disaster Management Officer	Member	9073940149
Line Departments				
3	Saiyed Sarwar Ussan	Additional Director of Agriculture	Member	9609784180
4	Dr. Md. Masud Rahaman	Block Medical Officer of Health	Member	7001310956
5	O/C of Police Station, Ratua	O/C of Police Station, Ratua	Member	9083270319
6	Samir Kanti Biswas	Block Land & Land Reforms Officer	Member	7719360788
7	Golam Mahabub	Child Development & Project Officer-in-Charge	Member	9083785654
8	Azizur Rahaman	Sub-Inspector (School), Ratua New Circle-in-Charge	Member	9614833650
9	Tarikul Islam	Sub-Inspector (School), Ratua Circle	Member	8926360250
10	Paramita Maiti	Block Livelihood Development Officer	Member	8926566040

Crisis Management Team with Contact No.

Sl. No.	Name of the team member	Designation	Contact / Ph. No.	Name of team
1	Abeda Begum	Savapati, Ratua 1	6294438474	Early Warning Team
2	Sarwar Ali	B.D.O, Ratua 1	7719360735	
3	Sri Saikat Dutta	Jt. BDO	9073938565	
4	Sri.Parimal Chandra Barman	Addl. Ins. BCW	9933407619	

5	Saiyed Sarwar Ussan	A.D.A.	9851355089	
6	Sri. Soumodip Jha	J.P.O.	9733184855	
7	Hamida Banu	Sahakari Savapati	9733213991	
8	Sri Anup Kumar Singhs	RWP(Mech.)	9775844248	
9	HAJERA BIBI	Karmadhyaksha, Tran	7478980468	
10	Abeda Begum	Savapati, Ratua 1	6294438474	Relief & Rescue team
11	Sarwar Ali	B.D.O, Ratua 1	7719360735	
12	Sri Saikat Dutta	Jt. BDO	9073938565	
13	Sri.Parimal Chandra Barman	Addl. Ins. BCW	8013766382	
14	Argha Kamal Ray	FEO	9474412196	
15	Md Matiur Sk.	Cashier	8145893328	
16	Sri. Soumodip Jha	J.P.O.	9733184855	
17	Sri. Surajit Poddar	A/C (RD)	9775976040	
18	Sri.Sekhar Das	Driver	9832527531	
19	Dr. Masud Rahaman	BMOH	7001310956	
20	Sri Saikat Dutta	Jt. BDO	9073938565	
21	Sri.Parimal Chandra Barman	Addl. Ins. BCW	9933407619	
22	MD .RABBANI	Karmahdyaksha, Janasasthya	8942077292	
23	Dr. Masud Rahaman	BMOH	7001310956	
24	Dr. Arnab Roy	Gen. Physician	9735104684	
25		Gen. Physician		
26		Head Nurse		
27		Nurse		
28		Pharmacist		
29	Sri Samar Mukherjee	M.L.A., 48, Ratua	9433107010	Water Sanitation Team
30	Sarwar Ali	B.D.O, Ratua 1	7719360735	
31	Hamida Banu	Sahakari Savapati	9733213991	
32	MD .RABBANI	Karmahdyaksha, Janasasthya	8942077292	
33	Sri Nihar Ranjan Biswas	JE(RWS)	9734992931	
34	Sri Biswajit Sinha	JE (BP)	9832392849	Carcase Disposal Team
35	Sri Saikat Dutta	Jt. BDO	9073938565	
36	Sri. Biswajit Sinha	JE. (BP)	9832392849	
37	Argha Kamal Ray	FEO	8296713842	
38	Sri Shekhar Das	Driver	9832527531	
39	Sri Sanjay Sarkar	CCT	8918735706	Relief Distribution Team
40	Smt. Hamida Banu	Saha. Savapati Ratua-1	9733213991	
41	Sarwar Ali	B.D.O, Ratua 1	7719360735	
42	Sri Ratan Oraon	BDMO	9735026833	
43	Sri Parimal Chandra Barman	Addl. Ins. BCW	9933407619	
44	Rosen Jamil	AHC	9434817087	
45	Sri Surajit Poddar	AC	9775976040	
46	Sri Anup Kumar Singhs	RWP(Mech.)	9775844248	Damage Assessment Team
47	Sarwar Ali	B.D.O, Ratua 1	7719360735	
48	Abeda Begum	Savapati, Ratua 1	6294438474	
49	Sri Ratan Oraon	B.D.M.O.	9735026833	

50	Dr. Paramita Mitra	BLDO	8926566040	
51	Ashfakur Rahaman	N.G.O (MERDAS)		
52	Saiyad Sarwar Ussan	A.D.A.	9609784180	
53	Sri Samar Mukherjee	M.L.A 48, Ratua LAC	9433107010	Advisory and Co-ordinary Team
54	Abeda Begum	Savapati, Ratua 1	6294438474	
55	Sarwar Ali	B.D.O, Ratua 1	7719360736	
56	Sri Saikat Dutta	Jt.BDO	9073938565	
57	Sri Debabrata Chakraborty	O.C Ratua P.S	9083270319	
58	Saiyed Sarwar Ussan	A.D.A.	9851355089	
59	Sri Parimal Chandra Barman	Addl. Ins. BCW	9933407619	
60	Sri Samar Mukherjee	M.L.A 48, Ratua LAC	9433107010	
61	Abeda Begum	Savapati, Ratua 1	6294438474	
62	Sarwar Ali	B.D.O, Ratua 1	7719360736	
63	Member BDMC	Member BDMC		
64	Sri. Biswajit Sinha	JE. (BP)	9832392849	
65	Hazrat Ali	BC	9733417168	
66	Enamul Hoque	N.G.O.		

COUNTRY BOAT & MECHANISED BOAT DEPLOYMENT DETAILS WITH CONTACT NO. & NAME OD BOATMAN

Name of Boatman with Contact No.

Sl. No.	Name of Boat Owner	Father's name	Address	Contact No.
1	Atul Ghosh	Panchu Ghosh	Vill: Balupur Diara P.O: Balupur Dist. Malda	9735425362
2	Durga Yadav	Naresh Yadav	Vill: Bankutola P.O: Sambalpur Dist. Malda	9733103118
3	Basukinath Yadav	Jamuna Yadav	Vill: Bankutola P.O: Sambalpur Dist. Malda	9733208522
4	Bikash Mandal	Chandrakanta Mandal	Vill: Janjalitola P.O: Maniknagar Dist. Malda	9733162637
5	Muktar	Saifuddin	Vill: Nayabilaimari P.O. Bilaimari Dist. Malda	9733396727
6	Jinnat Ali	Amtaz Ali	Vill. Ratanpur P.O. Bilaimari Dist. Malda	7602744879
7	Sushil Yadav	Rasiklal Yadav	Vill. Bodharamtola P.O. Mahanandatola Dist. Malda	9735081631
8	Tulsi Mandal	Kuttu Mandal	Vill. Jitutola P.O. Mahanandatola Dist. Malda	9134473200
9	Sukhen Choudhury	Amir Choudhury	Vill. Piyari Sarkartola P.O. Mahanandatola	9564053300

			Dist. Malda	
10	Kalachad Choudhury	Jagadish Choudhury	Vill. Sudamtola P.O. Mahanandatola Dist. Malda	9733137289
11	Baiju Mandal	Pachu Mandal	Vill. Chaitutola P.O. Mahanandatola Dist. Malda	8348934312
12	Dayal Mandal	Golak Mandal	Vill. Maliramtola P.O. Mahanandatola Dist. Malda	9775735450
13	Laxman Mandal	Bhujan Mandal	Vill. Kotualy P.O. Mahanandatola Dist. Malda	9734956047
14	Biren Mandal	Upen Mandal	Vill. Nabagram P.O. Mahanandatola Dist. Malda	9775284738
15	Chhottu Jadav	Bramhadev Yadav	Vill. Bhaluka P.O. Bhaluka Dt. Malda	9733103118
16	Mainul Hoque	Abdul Basir	Vill. Mahanandatola P.O. Mahanandatola Dt. Malda	9733201020
17	Bhabesh Mandal	Fekan Mandal	Vill. Mahanandatola P.O. Mahanandatola Dt. Malda	9733189532
18	Haridas Mandal	Khoka Mandal	Vill. Mahanandatola P.O. Mahanandatola Dt. Malda	7872890182

Operation of EOC: To be opened during monsoon period or emergency situations.

CONTROL ROOM AND CRISIS MANAGEMENT TEAM WITH CONTACT NO.

Control Room Team with Contact No:

Sl. No.	Name of Staff	Designation	Contact/ ph.no.	Office Ph. No.
1	Abeda Begum	Savapati, Ratua 1	6294438474	
2	Sarwar Ali	B.D.O, Ratua 1	7719360735	
3	Sri Saikat Dutta	Jt. BDO	9073938565	
4	Sri. Kunal Ghosh	BIO	9474795442	
5	Sri Somedipta Bhowmik	JE(RWS)	9064016223	
6	Sri. Biswajit Sinha	S.A.E. (BP)	9832392849	
7	Sri Ratan Oraon	B.D.M.O.	9735026833	
8	Sri. Soumodip Jha	J.P.O.	9733184855	
9	Rosen Jamil	AHC	9434817087	
10	Hazrat Ali	BC	9733417168	
11	Sri Sujay Sarkar	EOME	7908559512	
12	Sri.Parimal Chandra Barman	Addl. Ins. BCW	9933407619	
13	Sri Anup Kumar Singhs	RWP(Mech.)	9775844248	
14	Sri Surojit Poddar	Accounts Clerk	9775976040	
15	Sri.Subrata Roy	U.D.C.(PC)	9474472040	
16	Sri Subhasish Kumar	DEO	9641656469	

Social Activities:

Sl. No.	Name of Office	Address	Contact Phone & Fax No.
1	D.M., Malda	Malda Collectorate, Malda	7719360700/03512-252381, 253030
2	A.D.M (G), Malda	Malda Collectorate	7719360701/03512-252351
3	A.D.M (D), Malda	Malda Collectorate	7719360702/03512-252049
4	A.D.M (LR), Malda	Malda Collectorate	7719360703/03512-252355
5	A.D.M (ZP), Malda	Malda Collectorate	7719360704/03512-252328
6	District Relief Officer, Malda	Malda Collectorate	03512-252355 03512-252058
7	O.C. Relief, Malda	Malda Collectorate	7719360748/03512-252058
8	DDMO, Malda	Malda Collectorate	9073936737/9933308303
9	SDDMO, Chanchal Sub-Division	SDO, Chanchal	9073936949
10	B.D.O.	Ratua-1 Development Block	9073938565
11	S.P.	Malda	9083270300/03512-252520
12	Police Mobile		9434206708
13	S.D.O Irrigation, Malda		03512-254350
14	Ex. Eng. P.W.D Div-1, Malda		03512-252598
15	Sub-Divn.Live stock Register		953422563416
16	O.C.Fire Station (Fire Bridge), Chanchal		8514908800/03513-252111, 252101
17	Fire Bridge, Malda		03512-252054
18	Asstt. Eng. W.B.S.E.B		03513266215
19	Deputy controller civil Defiance Malda.		03512-252017
20	A.D.A., Ratua-1		9609784180/03513-266324
21	Ashfakur Rahaman		9734180066
22	S.D.O Sadar Malda		03512-252933
23	Sub- Divisional Officer Chanchal, Malda		03513- 252872
24	B.D.M.O Ratua-1, Malda		9073940149/9732640315
25	Savapati, Ratua-1 PS		9733245180/6294438474
26	Notary Club, Malda		03512-251544
27	S.D.O Agril Chancha, Malda		03513-252235
28	Dr. Masud Rahaman	BMOH, Ratua, Malda	7001310956
29	St.Jhon Ambulance, Malda		03512-252751
30	C.M.O.H., Dist. Hospital, Malda		9831048213/03512-254611/252280
31	Sr. S.O.I., Civil Defence	Malda	03512-252017/9434245961
32	Electric Sub- Station, Ratua-1		
33	Flood Control Cell		03512-254300
34	Golam Mahabub	C.D.P.O., Ratua-1	9083785654
35	Mridula Jha	Supervisor	9475094283
36	MERDAS	NGO	
37	Malda Welfare Society	NGO, C/o Gautam Ghosh, Womens College Road Malda	+91-3512-223226 Mobile: +91-94341 89860

38	Chanchal Jana Kalyan Samiti	NGO, College Road Malda	+91-3513-252805 Mobile: +91-94343 55550
39	IMA	NGO	252132/
40	Red Cross	NGO	252093/98000181159/9800459888
41	St. John Ambulance	NGO	252751/9434193341
42	Bharat Sevashram	NGO	260459/8637847609
43	Ram Krishna Mission	NGO	252479/03512-252479
44	Lions Club	NGO	252398/9434186135
45	Rotary Club	NGO	9126215099
46	Malda Chamber of Commerce	NGO	266028/9434206618
47	Sanskriti O Samaj Unnayan Parishad	NGO	03512-267423/9434012392

Ambulance Driver with Contact No:

Sl. No.	Name of Ambulance owner	Ambulance No.	Contact No.
1	Anwar Hossain, Ratua Ailpara	WB-65A-1612	9734990116
2	Nasim Sarwar, Ratua Ailpara	WB65-0008	9153649685
3	Aripful Rahaman, Ratua	WB59-2247	9932169118
4	Md. Kakil, Ratua	-	9679084281
5	Kabir, Ratua	WBC65-2017	9734902607
6	Akbar Ali, Ratua	WB65-7085	9775970131
7	Md. Yousuf Ali, Ratua	WB04-1702	9733051835
8	Golam Rabbani, Ratua	WB65-5079	7076439674
9	Abu Kalam, Ratua		9733237149
10	Chanchal Janakalyan Samity, Ratua	WB65-9106	9932169118
11	Rahim Khan, Ratua	WBE-2073	9733207113
12	Rahim, Ratua	Wb65-3344	9735135011
13	Saheb, Samsi	WB31-4539	9733183526
14	Saheb, Samsi	WB29-6157	9733183526
15	Khadibun, Samsi	WB78-0794	9609771596
16	Pandab, Samsi	WB65-1363	8016141108
17	Basu, Samsi	WB02-6506	9733038160

Plan to Co-ordinate with PHE for Safe Drinking Water:

Sl. No.	Name of Officials	Designation	Contact No.
1	Sarwar Ali	BDO	7719360735
2	Saikat Dutta	Jt. B.D.O.	7718211300
3	Nihar Ranjan Basak	JE(RWS)	9734992931
4	Ratan Oraon	BDMO	9735026833
5	Anup Kumar Singha	RSW (Mechanic)	9775844248
6	Nawabuddin	LDA	9735231807

List of Ambulance:

Sl. No.	Name of Ambulance owner	Ambulance No.	Contact No.
1	Anwar Hossain, Ratua Ailpara	WB-65A-1612	9734990116
2	Nasim Sarwar, Ratua Ailpara	WB65-0008	9153649685
3	Aripful Rahaman, Ratua	WB59-2247	9932169118
4	Md. Kakil, Ratua	-	9679084281
5	Kabir, Ratua	WBC65-2017	9734902607
6	Akbar Ali, Ratua	WB65-7085	9775970131
7	Md. Yousuf Ali, Ratua	WB04-1702	9733051835
8	Golam Rabbani, Ratua	WB65-5079	7076439674
9	Abu Kalam, Ratua		9733237149
10	Chanchal Janakalyan Samity, Ratua	WB65-9106	9932169118
11	Rahim Khan, Ratua	WBE-2073	9733207113
12	Rahim, Ratua	Wb65-3344	9735135011
13	Saheb, Samsi	WB31-4539	9733183526
14	Saheb, Samsi	WB29-6157	9733183526
15	Khadibun, Samsi	WB78-0794	9609771596
16	Pandab, Samsi	WB65-1363	8016141108
17	Basu, Samsi	WB02-6506	9733038160

DISASTER MANAGEMENT PLAN
OF
RATUA-II DEVELOPMENT BLOCK
FOR THE YEAR 2020-2021
PUKHURIA, MALDA

Introduction

Natural disasters continue to strike without notice and are perceived to be on the increase in their magnitude, complexity, frequency and economic impact. These hazards pose threat to people, Infrastructures and economic assets and assume disastrous proportions when they occur in areas of dense human habitations.

Ratua-II Block is situated at the right side of River Mahananda. Geographical area of Ratua-II Block is 173.93 Sq. Km. consisting of 8 Gram Panchayats covering 51 mouzas, 112 villages and 103 Gram Sansad. The total population as per 2011 Census is 202048.

It appears from the Previous record that in the year of 2017, due to overflow of Mahananda, Mara Mahananda, Kalindri river and heavy rain & water logging in Kalapahar Khal and Kashadara Khal, 45 mouzas under Pirganj, Maharajpur, Pukhuria, Sripur I & II, Sambalpur and Aridanga Panchayat were fully affected. Almost 13000 nos. of huts was damaged (Fully/Partly) and about 105207 people were affected, 4950 hector Aman crops 300 hectors Aush crop and 2315 hector vegetables were severally damaged of property and crops in almost 8 GPs

This plan have been prepared in anticipation of mitigating and preparedness to reduce human misery in the event disaster like flood, cyclone, water logging, fire, lightening, accident or house collapse etc. Action plans at Gram Sansad level & G.P. level are prepared for fighting the disasters.

I hope that this plan will be useful to the officials of line department and Panchayat functionaries of this Block at the time of crisis during natural calamity or any kind of disasters. It is requested to all concerned to extend their hands to helpless and distressed people at the time of cricis.

BLOCK CONTROL ROOM Ph. No.03513-282250./03512-250282

Sl. No	Name of Staff	Designation	Contact Ph. No.	Office Ph. No.
1	Sourav Paul	Jt. BDO	8697190836	
2	Anay Hazra	FEO	9434372211	
3		SAE.(PHE)(RWS)		
4		SAE (Relif)		
5	Avik Goul	SAE(RWP)	9804192940	
6		Insp. (F&S)		
7	Soumen Roy	(Relief in Charge)	9434955000	
8		RWP(TC)		
9	Yousuf Ali	DS(PS)		
10	Shyamal Mandal	Cashier	9733163406	
11	Raja Sarkar	Accountant Panchayet Samity.	9563377759	
12	Ganesh Acherjee	Casual	86709-04038	
13	Hudua Bhagat	Casual	96794-23466	
14	Nimai Mandal	Night Guard		

Remarks:

Deployment of Staff for Sub-Control room at Gram Panchayet Level noted in the Gram Panchayat Plan.

Disaster Management Teams

Sl. No.	Name of Team	Name of Team Members	Designation	Contact No.
1.	Early Warning Team	Sumitra Sarkar	Sabhapati	8944099630
		Somnath Manna	BDO	7719360736

Sl. No.	Name of Team	Name of Team Members	Designation	Contact No.
		Jhaton Prashad	OC, Police	9434063114
		Tanay Saha	ADA	03513-282759
			CDPO	
		Siuli Khatun	Saha-Sabhapati	7063147419
		Monjila Bibi	Karmadhyakshya, SONJOT	8016699479
		Arun Ch. Karmakar	BWO	9775810138
		Soumen Roy	L.D.A. (Relief in charge), Ratua-II	9434955000
		Ganesh Acherjee	Casual	86709-04038
			Group D	
2.	Relief & Rescue Team	Samar Mukherjee	MLA, 48-Ratua	94331-07010
		Alberoni	MLA, 47-Malatipur	
			Member ZP	
			Member, ZP	
			SDO, Irrigation	
			SAE, RWS	
			SI, Schools, C- 1	
			Ins. F & S	
			Pradhan, Maharajpur GP	
			Pradhan Pirganj GP	
			Pradhan, Sripur—I & II	03512-280218 9333716756
			Sourav Paul	Jt. BDO

Sl. No.	Name of Team	Name of Team Members	Designation	Contact No.
			Inspector, M&W	
3.	First Aid Team	Dr. Deb Kumar Mandal	BMOH	8013535099
			Gen. Physician	
			-Do-	
			-Do-	
		Sunita Bhagat	Head Nurse	6289226004
			PHN	
			Pharmacist	
			Volunteer	
			Volunteer	
			Volunteer	
			Volunteer	
			Volunteer	
			Volunteer	
			Volunteer	
4.	Water and Sanitation Team		SAE, RWS	
		Eraman	Karmadhyakshya, Janaswasthya	97333-75828
			Member, Ratua-II PS	
			SAE, BP	
			SAE, Relief	
5.	Carcass Disposal Team	Samar Mukherjee	MLA, 48-Ratua	
		Siuli Khatun	Saha-Sabhapati	7063147419
			Member, BDMC	

Sl. No.	Name of Team	Name of Team Members	Designation	Contact No.
			Karmadhyakshya, SOSTOK	
			Inspector, M&W	
			RWP-TC	
6.	Relief Distribution Team	Siuli Khatun	Saha-Sabhapati	7063147419
		Somnath Manna	BDO	7719360736
			Ins. F & S	
		Monjila Bibi	Karmadhyakshya, SONJOT	8016699479
		Sourav Paul	Jt. BDO	7063377159
		Soumen Roy	L.D.A. (Relief in Charge)	9434955000
		Sanuara Khatun	Karmadhyaksha, Purta	9733045510
		Shyamal Mandal	Cashier	9733163406
7.	Damage Assessment Team		Member, BDMC	
			Member, Ratua-II PS	
			VO-BAHC, Shyamsundar	
			LEOME	
			BLDO	94342-03503
8.	Advisory and Coordinating Team	Sumitra Sarkar	Sabhapati	8944099630
		Somnath Manna	BDO	7719360736
		Sourav Paul	Jt. BDO	8697190836
		Jhaton Prashad	OC, Police	9434063114

Sl. No.	Name of Team	Name of Team Members	Designation	Contact No.
		Tanay Saha	ADA	03513-282759
		Hemonto Mani	CI	8001577647
		Monjila Bibi	Karmadhyakshya, SONJOT	8016699479
9.	Shelter Management Team	Sumitra Sarkar	Sabhapati	8944099630
		Somnath Manna	BDO	7719360736
		Samar Mukherjee	MLA, 48-Ratua.	
			Member, BDMC	
		Monjila Bibi	Karmadhyakshya, SONJOT	8016699479
		Tusar Kanti Barman	SAE (BP)	8768775325

****Important**

Name of important ferry ghats with contact person		
Name of ghat	Contact person	Contact No
Paranpur	Sayed Rabiul	8101498461
Betaha	Sk Munser	9609773010
Balughat		9679321101

Contingency Plan : Manikchak Dev Block

Hazards, Vulnerability, Capacity & Risk Assessment (HVCRA): Description of history of flood and incurred losses:

Year	Name of G.P. affected	Name of Village Affected	No. of people Affected	No. of Human life lost
2016	Manikchack	Ramnagar, Jotpatta, Haddatola, Torabalitola, Shibontola Narayanpurchor(Dhormutola, Bechutola)	2100	01
	Hiranandapur	Godai(Samsad 1 & 2), Giridharitola	1500	
	Dakshin Chandipur	Duanir Chor	200	
2017	Gopalpur	Elahitola, Ishwartola, Kalitola, Sahabottola.	2000	01
	Hiranandapur	Suksena, Bhobanitola	320	
	Dakshin Chandipur	Narayanpur Chor (Partly)	200	
2018	Hiranandapur, Manikchak (partly)Dakshin Chandipur(partly), Uttar chandipur(partly)	Godai Chor, Ramanagar, Piyaritola, Pulintola, Sukdevtola, Giridharitola, Nazirudintola, Lakshutola	1300	0
2019	Manikchak, Hiranandapur, Dakshin Chandipur, Gopalpur, Dharampur, Nazirpur(Partly), Nurpur(Partly), Mathurapur(Partly), Uttar Chandipur(Partly), Chowki Mirdadpur(Partly)	Godai Chor, Rajkumartola, Santinagar, Jagannathtola, Giridharitola, Ramnagar, Jotpatta, Durgaramtola, Bamacharantola, Duarnir Chor, Lutihara, Gopaltola, Balutola, Narayanpur Chor, Kamaltipur, Jalalpur, Munnar Bagan, Laxmikole, Utshobtola, Jalalpur, Giritola, Bhimtola, Sahebramtola, Karticktola, Haripur, Uttar Hukumattola, Jitmanpur, Wahedmara, .Dallutola Sabjipara, Shyamlalpara, Tiyorpara, Giritola, Bhabanitola.	43000	01

Population Details of the Manikchak Development Block (Census-2011)

GP Name	Total Population	Male	Female
Hiranandapur	21903	11349	10554
Uttar Chandipur	34264	17580	16684
Mathurapur	29758	15422	14336
Dakshin Chandipur	26418	13840	12578
Manikchack	28261	14632	13629
Enayetpur	23780	12168	11612
Chowki Mirdadpur	27228	14143	13085
Dharampur	13140	6865	6275
Gopalpur	18427	9564	8863
Nazirpur	15945	8287	7658
Nurpur	30411	15713	14698
Total	269535	139563	129972

Control Room and Crisis Management team with contact no:

Sl No.	Name of Sector	Name of Officer / Staff	Designation	Phone No.
1	Manikchak	1. Subir Paul	FEO	9231828109
		2. Keshab Ch Das	DEO	8900647544
		3. All G.P Staff		
2	Mathurapur	1. Anupam Ch. Chakraborty	Dy. Secretary [PS]	9064382896
		2. Pallab Mandal	Panchayet Clerk	9641663262
		3. All G.P Staff		
3	Nazirpur	1. Pradip Kr. Das	PDO	9735718428
		2. Biswajit Das	LDA	8918848857
		3. All G.P Staff		

4	D.Chandipur	1. Supratik Das	BWO	8759602816
		2. Prosenjit Sarkar		
			UDC(PS)	9733205325
		3. All G.P Staff		
5	Hiranandapur	1.Sumangal Das	Jr. Engineer(BP)	9064360167
		2. Tilak Rajak	AO	8918887819
		3. All G.P Staff		
6	Uttar Chandipur	1.Sougata Mitra	IMW	9749641955
		2. Subhadip Ghosh	Accounts clerk	9474797213
		3. All G.P. Staff		
7	Nurpur	Monotosh Sarkar	AAEO	7384207699
		2. Nurul Islam	Asst. Acct, MDM	9734968071
		3. All G.P Staff		
8	Gopalpur	1.Sukanta Biswas	EOMEE	9474418361
		2.Shyamal Ghosh	O.C.M.	8927498824
		3. All G.P Staff		
9	Chowki Mirdadpur	1. Probodh Kr. Das	SAE (AI)	9932303881
		2. Prasenjit Das	JSE(SWAN)	9153038483
		3. All G.P Staff		
10	Dharampur	1.Dilip Saha	C.I	9434872054
		2.Tapas Basak	Data Manager	9851111123
		3. All G.P Staff		
11	Enayatpur	Probal Bhomik	BPM	9733314297
		2. Md. Rousan Alam	CCT	9734910573
		3. All G.P Staff		

12	Block Control Room	1.Palash Das	BDMO	8013244985
		2. Jayanta Mandal	RC	8101850163
		3. Anup Mukherjee	Cashier PS	9831044641
		4. Prabhat Karmakar	A/C RD	9932303881
		5. Debashish Ghosh	BLF	8653172196
		6. Pipasha Halder	PEON(P.S.)	7031909880
		7. Md Yasin Ali	Driver	8972277882
		8. Pradyut Sarkar	NG TCPC	9851593599
		9. Latika Saha (Dey)	Gr-D, TCPC	9749313265

Important Telephone No. and Address of N.G.O., Social Worker:

Name of N.G.O.	Name of volunteers	Contact no.
Dharampur Palipally Health Awareness Organisation	Uttam Kr. Jha	9434154307
	Narayan CH. Jha	9933504413
	Bikash Chandra Sarkar	9475309602
	Rothindranath Chaki	9434725094
	Samaresh Sarkar	9734919767
White Feathers	Arzazul Hoque	7407020754
	Sk. Habibuddin	8768428775
	Sakiur Rahaman Khan	9734014668
	Tanvir Khan	9763431205

Civil Defence Personnel to be deployed for search and Rescue Operation:

Sl. No.	Name	Contact No.
1	Ramananda Pramanik	6295838567
2	Palash Pramanik	8637571599
3	Biman Goswami	9064708312
4	Situ Pramanik	9933670226
5	Ajoy Ghosh	9064712647
6	Subhankar Mandal	7001861627
7	Amit Das	9564939460
8	Nitai Rajak	9744999663
9	Timir Chowdhury	7031883274
10	Prasenjit Karmakar	9733248987
11	Gopal Karmakar	9933520590

12	Sarajit Ghosh	8906088048
13	Chiranji Karmakar	9749944933
14	Mintu Ghosh	8101488971
15	Misbaul Hoque	9563507472
16	Babar Ali	9069059450
17	Saidur Rahaman	9614468357
18	Avinay Mandal	8116330385

List of Doctors and Contact no.:

Sl. No.	Name of Doctors	Contact no.
1	Hemnarayan Jha (BMOH)	9748231194/7890391168
2	Dr. Amal Kumar Pal	9434425631
3	Dr. Kishore Boron Thakur	7800262739
4	Dr. Tabrej Rahaman	7797972483
5	Dr. Rajesh Saha	9775454508
6	Dr. Ashish Mishra	9775960465
7	Dr. Rathin Kundu	9834680611

Emergency Storage of life saving Drugs, stock of antivenom & Ambulance with Contact no.

Sl.No.	Name of Institution	Contact No.
1	Manikchack R.H.	03512-272329
2	Bhutni PHC	9775454508
3	Nurpur PHC	9834680611
4	Mathurapur PHC	9775960465

Name of the Driver of Ambulance with Contact No.

Sl. No.	Name of Driver	Contact No.
1	Tapas Basak	8337837074
2	Mithun Mandal	7718285251
3	Rajul Ali	9734797101
4	Srikanta Mandal	9734050103
5	Taleb Ansari	7872090927
6	Ujjal Poddar	9735995835
7	Mithu Mandal	8944084687
8	Bhim Pramanik	7797982247
9	Akbar ali	9733419040
10	Satrughna Mandal	8972624370
11	Radheshyam singha	7547967462
12	Debasish Ghosh	8768837162
13	Kinkor Ghosh	9735102742
14	Md. Sahabuddin	9734173634
15	Ganesh Mandal	9564463710

Country Boat with contact no. of Boat man:

Sl. No.	Name of Boat man	Contact No.	Carrying Capacity
1	Philip Mandal	9547878633	50 persons
2	Bikash Mandal	9775869569	50 persons
3	Nipen Mandal	7718384902	45 Persons
4	Pawak Mandal	8670370343	65 Persons
5	Nagen Mandal	7872293874	55 Persons
6	Bapi Mandal	7076636151	50 Persons
7	Choton Mandal	7479275927	40 Persons
8	Janardhan Mandal	9775884094	40 Persons
9	Nurul Hoque	7047716475	70 Persons
10	Deben Mandal	9609338043	70 Persons
11	Tilak Chand Chowdhury	7076968049	70 persons
12	Bablu Mandal	8116704125	70 persons
13	Jullur Rahaman	9593240245	70 persons
14	Kanchan Mandal	8768154183	65 Persons
15	Tahir Ali	9734970590	10 persons
16	Mojibar Rahaman	7364927210	10 Persons
17	Sankar Mandal	9679757108	Country Boat (D. Chandipur)
18	Dilip Mandal	8167313928	Country Boat (D. Chandipur)
19	Gopinath Chowdhury	7477538660	Country Boat (D. Chandipur)
20	Sudam Chowdhury	7407479343	Country Boat (D. Chandipur)
21	Hajrat Ali	8670706211	Country Boat (D. Chandipur)

Contingency Plan : Bamangola Dev Block

Vulnerable Areas- Name of G.P.

The villages under Madnabati GP : Baherpur, Fichadanga, Gupidanga, Kanyadighi, Nalaganj, Uttar Khoksan, Dakshin Khoksan, Uttar Chandrail, Bakchar, Doulatpur, Garapara, Barshipara, Bholamasna, Kupadaha, Ishani, Nababnagar.

The villages under Gobindapur-Maheshpur GP : Jhakaldanga, Chhaitantala, Maynafala, Sapmari, Goapara, Badiyapara, Jamdanga, Bokadaha, Rangamati, Kalaidanga, Katragachi, Gunaidanga, Thangbhanga.

The villages under Chandpur GP : Battali, Khutadaha, Hanspukur, Taltali, Bhulkimari, Nandinadaha, Shonghat.

The villages under Jagdala GP : Baravita, Doba Hanspukur, Adadanga, Talvita, Ashrampur.

The villages under Pakuahat GP : Rakhalpukur, Telchitka, Maldanga, Chaulitala, Alampur, Dighalbar.

The villages under Bamangola GP : Kathuadanga, Parhabinagar, Dakatpukur, Buridanga, Bamangola, Dharmadanga, Nimdanga, Sikail, Rangapukur, Dogachha, Siskuri.

Population

As per 2011 Census of India, Bamangola CD Block had a total population of 143,906, all of which were rural. There were 74,071 (51%) males and 69,835 (49%) females. Population below 6 years was 16,297. Scheduled Castes numbered 71,176 (49.46%) and Scheduled Tribes numbered 28,990 (20.15%).

Large village (with 4,000+ populations) in Bamangola CD Block were (2011 population in brackets): Salalpur (4,877). Other villages in Bamangola CD Block included (2011 population in brackets): Jagdala (1,072), Chandpur (1,193), Gopalpur (878) and Mahespur (742).

Mechanism of dissemination of warning message by E-mail/Whats app. Group/ mobile:

TRIGGER MACHANISM-2020-21

Sl. No	Name	Mobile No	Designation	Responsibility
1	Sri. Sanjit Mondal	9434738458	Block Development Officer, Bamangola Dev. Block	1. General supervision of total relief operation at block level. 2. Policy decision. 3. Liaison with higher authority & line

				department.
2	Sri Asish Nayek	8768526979	Jt. B.D.O. Bamangola Dev. Block	2 nd in incharge to BDO and assist to in all above & act as reliver.
3	Charan Soren	9733218791	AAEO, Bamangola Dev. Block	Officer-in-Charge , Relief to execute & co-ordinate in relief operation
4	Sandip Sinha,	9434819915	SAE(BP)	To assist BDO & co-ordinate in all work
5	Sandipan Deb,	9563105787	EOMEE	To assist BDO & co-ordinate in all work
6	Pankaj Kr. Biswas,	9434966921	CDPO	To assist BDO & co-ordinate in all work
7	Animesh Datta,		JE(Civil)	To assist BDO & co-ordinate in all work
8	Falesh Ch. Barman	9064020274	UDA	Co-ordinate in all relief matter

Control Room & Crisis Management Team with Contact No.

Sl. No.	Name of Officers/ Staff	Designation	Contact Mobile No.
1	Sri Sanjit Mandal	B.D.O.	9434738458
2	Sri Asish Nayek	Jt. B.D.O.	8768526979
3	Shampa Chowdhury	WDO	9733001566
6	Sri Sandipan Deb	E.O.M.E.E.	8900526097
7	Choran Soren	AAEO	9733218791
8	Sri Ranjit Sarkar	E.C.	9733449909
9	Ganesh Mardi,	AHC	9734991154
10	Avijit Das	DEO	7001616881
11	Md. Kobad Ali,	UDPC	8250558504
12	Rajarshi Mandal,	Cashier(PS)	9434819549
13	Litan Sarkar,	ACPS	8906901583

14	Samarendranath Seth,	DEO(PS)	9064589266
15	Phani Bhusan Mandal	LDA	9800259192
16	Rakesh Das	Gr-D	8972465513
17	Prasanta Sarkar,	TA (MGNREGS)	9733132726
18	Suman Malick,	PA (MGNREGS)	8972298886
19	Hopna Tudu,	Peon (PS)	8145480196
20	Md.Monirujjaman,	BPHS	8768852636
21	Dipali Roy,	Supervisor(SSK)	9933826014
22	Dinesh Mandal,	BlockCo-ordinator	9734155874
23	Mithun Mandal,	Data Manager (Kanyashree)	9733260326
24	Alpana Roy,	Supervisor(SSK)	9733483277
25	Md. Tajamul Hoque,	AO	9734159262
26	Anup Kr. Sarkar,	Chowkidar	8016688470
27	Sarat Tudu,	Chowkidar	9609841966
28	Tapan Kr. Sinha,	Chowkidar	8942881868
29	Bijoy Kumar Choudhury,	AO	9733193149
30	Rita Mandal,	Peon	9932136555
31	Santi Roy,	OP	8145453562
32	Ashoka Das (Baskey),	Peon(Panchayat)	8016673630
33	Ashis Roy,	Driver	9932247738
34	Ajit Rabidas,	Dhaki	9547938135

Name of P.S Member & Contact No.

Sl No.	Name of the member	Name & No. of Constituency	Address	Mobile No.
1	PINKI KARMAKAR (SARKAR)	Madnabati/PS-1	VILL- SHIBDANGI, P.O.-MADNABATI, P.S.-BAMANGOLA, DIST-MALDA, PIN- 733124	8348524237
2	SUSHANTA KUMAR SARKAR	Madnabati/PS-2	VILL- NALAGOLA, P.O-NALAGOLA, P.S.-BAMANGOLA, DIST-MALDA, PIN-	9563218364

			733124	
3	PURNIMA BARAI DAS	Madnabati/PS-3	VILL- UTTAR NAYAPARA, P.O.- NALAGOLA, P.S.-BAMANGOLA, DIST- MALDA, PIN-733124	8145590845
4	BARNALI SARKAR	Gobindapur Maheshpur /PS- 4	VILL- KASHIMPUR, P.O. -NALAGOLA, P.S.- BAMANGOLA, DIST,- MALDA, PIN-733124	9593797278
5	PALTU BASKE	Gobindapur Maheshpur /PS- 5	VILL- RAMNAGAR, P.O. MAHESHPUR, P.S.- BAMANGOLA, DIST,- MALDA, PIN-732138	9800618729
6	PARUL KUJUR (ORAW)	Gobindapur Maheshpur /PS- 6	VILL- BELGHARIA, P.O-MOHESHPUR, P.S.-BAMANGOLA, DIST-MALDA, PIN- 732138	7076831705
7	PRANESWARI HEMROM	Bamangola/PS-7	VILL+, P.O-DHARMADANGA, P.S.- BAMANGOLA, DIST-MALDA, PIN- 732138	8348548620
8	SUNIL KUMAR BARMAN	Bamangola/PS-8	VILL- DAKATPUKUR , P.O- DHARMADANGA, P.S.-BAMANGOLA, DIST-MALDA, PIN-732138	8016261500
9	KRISHNA HEMRAM	Bamangola/PS-9	VILL- MALDAPARA , P.O- BAMANGOLA, P.S.-BAMANGOLA, DIST-MALDA, PIN-732138	7797804644
10	NANDITA BISWAS (MAJUMDAR)	NANDITA BISWAS (MAJUMDAR)	VILL- BOTTALI, P.O-KHUTADAHA, P.S.-BAMANGOLA, DIST-MALDA, PIN- 732138	8016358291
11	SIRIN AKTAR BANU	Chandpur/PS-11	VILL-PAUL, P.O-PAKUAHAT, P.S.- BAMANGOLA, DIST-MALDA, PIN- 732138	8670141812
12	SUMITRA RAY	Chandpur/PS-12	VILL- HANSPAKUR, P.O-PAKUAHAT, P.S.-BAMANGOLA, DIST-MALDA, PIN- 732138	9733105420
13	SUKHENDU HALDER	Pakuahat/PS-13	VILL- SALALPUR , P.O-PAKUAHAT, P.S.-BAMANGOLA, DIST-MALDA, PIN- 732138	8972960117
14	SONALI SOREN	Pakuahat/PS-14	VILL- THINAGAR , P.O-PAKUAHAT, P.S.-BAMANGOLA, DIST-MALDA, PIN- 732138	8972960117
15	ANNA ROY	Pakuahat/PS-15	VILL- MIRJAPUR , P.O-PAKUAHAT, P.S.-BAMANGOLA, DIST-MALDA, PIN-	9126838814

			732138	
16	MANISHA BARMAN MANDAL	Jagdala/PS-16	Jagdala/PS-16	8768109819
17	UTPAL SARKAR	Jagdala/PS-17	VILL- GAMGURIA, P.O-ASHRAMPUR, P.S.-BAMANGOLA, DIST-MALDA, PIN- 732138	8145555899
18	SANJIT MANDAL	Jagdala/PS-18	VILL- DOMADANGA, P.O- ASHRAMPUR, P.S.-BAMANGOLA, DIST-MALDA, PIN-732138	9933400758

GP wise Disaster Management Committee :

Gobindapur Maheshpur GP Office No. : 03511-264735

Sl. No.	Name	Designation	Contact No.
1	Pratima Mondal	Pradhan	7063496276
2	Hiramani Mardi	Upa Pradhan	9932795250
3	Pradip Roy	Member	8759509874
4	Dilip Roy	Member	9614749483
5	Shankar Debnath	Member	9800829753
6	Nagen Murmu	Member	9679866764
7	Himangshu Kr. Saha	E.A.	6295857527
8	Shashilal Sarkar	Secretary	7797985592
9	Bikram Sarkar	Sahayak	9733305246
10	Nipu Saha	Sahayak	8116845779
11	Dipali Chowdhury	G.P.K.	8372936725
12	Sukdeb Roy	G.P.K.	9733349287
13	Fulmoni Tudu	G.P.K.	8145332551
14	Babai Patra	G.R.S.	9635487991

Madnabati GP

Sl. No.	Name	Designation	Contact No.
1	Ranjita Halder (Majumder)	Pradhan	7076173332
2	Satya Ram	Upa Pradhan	9614313233
3	Sunil Besra	Member	7364903653
4	Najir Sarkar	Member	9593306375
5	Suresh Pujhar	Member	7550944611
6	Panchanan Mandal	Member	7318700982
7	Dibyendu Das	E.A.	7602740514
8	Santanu Dasgupta	Secretary	9593756280
9	Sukumar Hasda	Sahayak	9609743379

10	Dipak Sarkar	G.P.K.	9733389951
11	Samarjit Roy	G.P.K.	8348442106
12	Jagai Halder	G.P.K.	7076211891
13	Biswajit Paul	S.T.P.	9734107799
14	Kanailal Sarkar	G.R.S.	8759158064

Chandpur GP Office No. : 03511-266288

Sl. No.	Name	Designation	Contact No.
1	Subhash Bhakta	Pradhan	9083947746
2	Rajita Kisku	Upa Pradhan	9593306264
3	Sanjay Mandal	Member	9932295021
4	Biplab Soren	Member	7407477460
5	Shyamali Sarkar	Member	9593008438
6	Tuktuki Mondal	Member	9002721078
7	Mithun Mallick	E.A.	6290059272
8	Satyaranjan Biswas	N.S.	9733061913
9	Md. Yousuf Ali	Sahayak	8945576972
9	Subhankar Mardi	Sahayak	8145856603
10	Prahalad Bhakta	G.P.K.	7602064962
11	Pramila Das	G.P.K.	8016728692
12	Md. Alauddin Sarkar	G.P.K.	9733430035
13	Joyhari Adhikari	G.R.S.	9733082339

Jagdala GP

Sl. No.	Name	Designation	Contact No.
1	Tulsi Mondal	Pradhan	9734397717
2	Sadhan Chandra Mandal	Upa Pradhan	9733921339
3	Swapan Nath	Member	9002012433
4	Amritalal Sarkar	Member	9734911360
5	Shiben Baishyamali	Member	9734171917
6	Shambhu Roy	Member	9775969250
7	Dilip Ch. Bachhar	E.A.	9800692793
8	Mrinmoy Das	N.S.	9735014614
9	Goutam Kr. Paul	Secretary	9851700192
10	Subhendu Das	Sahayak	8670510797
11	Jhuma Biswas	Sahayak	9563229770
12	Sanjay Barai	G.P.K.	7797387762
13	Suniram Murmu	G.P.K.	9733112992
14	Lotan Kumar Misra	G.P.K.	9614761321

15	Swarup Biswas	S.T.P.	8016427229
16	Pallab Mandal	G.R.S.	9679350757

Bamangola GP Office No. : 03511-266336

Sl. No.	Name	Designation	Contact No.
1	Priyanka Barman	Pradhan	7583980047
2	Himangshu Mandal	Upa Pradhan	8371967723
3	Shyamal Murmu	Member	9932322802
4	Sanjoy Mandal	Member	8001420847
5	Gopal Halder	Member	9083108803
6	Narottam Roy	Member	9614867907
7	Manoranjan Karmakar	E.A.	9609977660
8	Pabitra Kumar Paul	N.S.	9434456849
9	Santanu Kundu	Secretary	9614412118
10	Amarjit Pan	Sahayak	9434818692
11	Bijaya Mandal	Sahayak	8370817984
12	Majibur Rahaman	G.P.K.	9733391648
13	Ananda Sanyasi	G.P.K.	9733393559
14	Kailash Chowdhury	G.P.K.	8972109836
15	Bapan Barman	S.T.P.	9800300404
16	Madhab Ch. Shil	G.R.S.	9932662702

Pakuahat GP

Sl. No.	Name	Designation	Contact No.
1	Sima Majumder Ghosh	Pradhan	9733419120
2	Mini Murmu	Upa Pradhan	9734182778
3	Rabindra Nath Urao	Member	9733105339
4	Susanta Biswas	Member	9735096168
5	Sushil Mondal	Member	8001716947
6	Bibhuti Bhusan Mandal	Member	9647769601
7	Madhabi Mandal	Member	9593613676
8	Arindam Lala	E.A.	9775435050
9	Abhisikta Singha	N.S.	9735566813
10	Shyamal Sarkar	Sahayak	9734987124
11	Krishnendu Kundu	Sahayak	8918178200
12	Bijay Roy	G.P.K.	9932466954
13	Utpal Barman	G.P.K.	7557847114
14	Satyanranjan Sarkar	G.P.K.	7797218207
15	Sourav Roy	G.R.S.	9851387864

Sl. No.	Name of the Officers & staff	Designation	Whatsapp/ Mobile No.
1	Sri Sanjit Mandal	B.D.O.	9434738458
2	Sri Asish Nayek	Jt. B.D.O.	8768526979
3	Sri Avijit Das	D.E.O.(M.D.M.)	9832619990
4	Santanu Dasgupta	Secretary, Madnabati GP	9593756280
5	Goutam Kr. Paul	Secretary, Jagdala GP	9851700192
6	Santanu Kundu	Secretary, Bamangola GP	9093734804
7	Shashilal Sarkar	Secretary, G.M.Pur GP	7797985592

Civil Defence Personnel to be deployed for search & rescue operation with contact no.

Sl. No.	Name of Civil Defence Personnel	Contact No.
1	Subrata Mandal	9734151802
2	Sonata Sarkar	9593744325
3	Anupam Ghosal	7797937297
4	Bidyasagar Mandal	8972046598
5	Shyamal Mandal	9775996302
6	Tapas Mandal	9002549862
7	Ashoke Baidya	9775837814
8	Tapas Roy	9733379393
9	Prashanta Mandal	9734915926
10	Ashim Bhakat	9734766625

List of Social Worker:

Sl. No.	Name	Contact No.
1	Subrata Mandal	9734151802
2	Sonata Sarkar	9593744325
3	Anupam Ghosal	7797937297

4	Bidyasagar Mandal	8972046598
5	Shyamal Mandal	9775996302
6	Tapas Mandal	9002549862
7	Ashoke Baidya	9775837814
8	Tapas Roy	9733379393
9	Prashanta Mandal	9734915926
10	Ashim Bhakat	9734766625

Medical Facilities & Contingency Plan with Contact No.

Activity	Name of Nodal Officer	Mobile No.	Alternative responsible officer(In absence of Nodal Officer)	Mobile No.
Overall	Dr. Sudip Kundu, Block Medical Officer of Health (BMOH)	7031106353	Dr. J.C. Mandal, 2 nd Medical Officer	9547900898
Reporting	Dr. Satish Gupta, M.O.	9083077970	Dr. Shyam Kanti Ghosh, M.O.	8670009181
Logistics(Drug)	Dr. J.C. Mandal, 2 nd Medical Officer	9547900898	Dr. Satish Gupta, M.O.	9083077970
Logistics(Transport)	Dr. Shyam Kanti Ghosh, M.O.	8670009181	Dr. Satish Gupta, M.O.	9083077970
Inter-sectoral co-ordination	Dr. Sudip Kundu, Block Medical Officer of Health (BMOH)	7031106353	Dr. J.C. Mandal, 2 nd Medical Officer	9547900898
Media Management	Dr. Sudip Kundu, Block Medical Officer of Health (BMOH)	7031106353	Dr. J.C. Mandal, 2 nd Medical Officer	9547900898

Sl. No.	Name of the Doctor	Place of posting	Mobile No.
1	Dr. Sudip Kundu	Bamangola Rural Hospital	7031106353
2	Dr. Jagadish Ch. Mandal	Bamangola Rural Hospital	9547900898
3	Dr. Shyam Kanti Ghosh, M.O.	Bamangola Rural Hospital	8670009181
	Dr. Satish Gupta, M.O.		9083077970

5	Dr. Motiur Rahaman (Dentist)	Bamangola Rural Hospital	7278038510
6	Dr. Atif Ali	Kashimpur P.H.C.	7044076082
7	Dr. Biswajit Banerjee	Kashimpur P.H.C.	9474364483
8	Dr. Ashis Biswas	Uttar Nayapara P.H.C.	9614123642
9	Dr. Santanu Bhowmick	Uttar Nayapara P.H.C.	9832821040

Important Telephone No. & Address of Resource persons of NGO &

List of NGO.

Name of NGO	No of Volunteers	Communication No
B.S.K.U.S	10	Dilip Mandal 9593719681
Maheshpur Welfare Society	23	Hasina Khatun 9733396748
Bamangola Life Line Welfare Society	11	Nirmal Podder 9593725227

Country Boat Deployment details with authentic contact no. & name of Boatman

Sl. No.	Name og Majhi	Name of Ghat	Name of River	Contact No.
1	Kartik Biswas	Kadubari Rangamati Ferry Ghat	Tangan	8670213046
2	Bimal Roy	Dakatpukur Ferry Ghat	Tangan	9733232175
3	Jitu Hemram	Chhotopathari Ferry Ghat	Hariya	8145572219
4	Ananta Mandal	Machua Ferry Ghat	Hariya	8158835606
5	Tafijul Sekh	Samsabad Ferry Ghat	Brahamani	9647701655
6	Hepdul Sekh	Shibdangi Ferry Ghat	Brahamani	
7	Balai Roy	Dharmadanga Ferry Ghat	Tangan	8167520083
8	Nakul Mandal	Parhabinagar Ferry Ghat	Tangan	7872836155
9	Tapas Bairagi	Thangbhanga Ferry Ghat	Tangan	6295458965
10	Juran Mandal	Bhangachura Ferry Ghat	Tangan	9382057328
11	Mangal Soren	Shiltani Ferry Ghal	Hariya	9647356865

12	Tarapada Tarafdar	Kathuadanga Ferry Ghat	Tangan	8001753272
13	Nepal Biswas	Ashrampur Kali Ferry Ghat	Hariya	8348557906

Contingency Plan : Habibpur Dev Block

Socio - Economic Profile of the Block

Population of Habibpur Block(As per 2011 Census)

Male	106,707 - 50.72%
Female	103,676 - 49.27%
Rural	185,642
Urban	25,357
Scheduled Castes	105,386
Scheduled Tribes	61,337
Density of population (per KM ²)	530

Percentage of Literacy: Male - , Female -

Geographical area (in Sq. K.M) – 397.10

Length of border boundary – 82.5 K.M

Total no. of village - 656

No. of backward villages – 140

Basic livelihood of the villagers – Agriculture, piggery, goatery, fishery, bidi making ,pottery , diary etc.

Total Cultivated Area : 3,9831.2 Hec.

Total area of single cropped Land – 26540 Hec.

Total area of Multi Cropped Land – 12011 Hec.

Total area of of Fallow Land – 6567 Hec.

Total area of Forest – 682,68 Hec.

Transport And Communication System:

Road : Surfaced- 179 K.M , Unsurfaced – 339 K.M

No. of Terminating Bus Route : 5

Waterways : Nil

Railways : Railway Station 7 K.M distance from Block H.Q

(Train Service not available)

Mechanism of Dissemination of warning message by e- Mail/ Mobile

Sl. No.	Name of G.P	Important G.P. Official.	Contact No.	Remarks
1.	Aktail	Prodhan -	9733226639	
		Executive Assistant-/Secretary	9933520360	
2	Baidyapur	Prodhan -	8001201110	
		Executive Assistant-/ Secretary	9733035277	
3	Mangalpura	Prodhan -	9734189831	
		Executive Assistant-/ Secretary	9734264709	
4	Jajail	Prodhan -	8016813191	
		Executive Assistant-/ Secretary	8759939023	
5	Kanturka	Prodhan -	8944827636	
		Executive Assistant- /Secretary	9851889668	
6	Dhumpur	Prodhan -	8637083838	
		Executive Assistant-/ Secretary	7872186246	
7	Habibpur	Prodhan -	9733081627	
		Executive Assistant-/ Secretary	9933812206	
8	Bulbulchandi	Prodhan -	9775889319	
		Executive Assistant-/ Secretary	9800618754	

9	Aiho	Prodhan -	7797188189	
		Executive Assistant-/ Secretary	9475247481	
10	Rishipur	Prodhan -	7319575134	
		Executive Assistant-/ Secretary	9563262775	
11	Sreerampur	Prodhan -	9679135956	
		Executive Assistant- /Secretary	9932065973	

Gram Panchayat wise responsible person for Disaster Management Plan

Habibpur Dev. Block Disaster Management Plan – 2018

Sl. No.	Name	Designation	Location	Responsibility	Phone No.
1	Sri Subhajit Jana	B.D.O	Habibpur	Overall charges Disaster Management	7719360740
2	Sri Tarun Kanti Barman	Jt. B. D.O	Habibpur	- Do -	8670754553
3	Golam Mehbub	P.D.O	Habibpur	In – charge of vehicle & boats and also to receive & transmit messages	9681443595
4	Sujit Kr. Lal	BDMO in charge (A.A.E.O)	Habibpur	All relief works, report & return distribution of Relief articles, Control room	9434193323
5	Kumud Ranjan Biswas	Relief Clerk	Habibpur	To help BDMO , In – charge of Relief godown	9647807981
6	Pani Murmu	Gr. D (Relief)	Habibpur	To help BDMO & Relief Clerk	7584923968
7	Samir Basak	P.S Clerk	Habibpur	To lift all Relief materials from Malda.	
8	Biswajit Basak	S.A.E	Habibpur	In – charge of drinking water & disinfection	9434519133
9	Santosh Mardi	Gr. D	Habibpur	To help P.D.O , BDMO , RC	
10	Shib Shankar Biswas	FFA	Habibpur	Officer In – charge of Mangalpura G.P	6295519887
11	Koushik Mandal	Sahayak	Mangalpura	To assist the O. C Mangalpura	9733176138
12	Atin Bagchi	Ins.BCW	Habibpur	O.C of Baidyapur G.P	8016131465
13	Jogeswar kisku	Secretary	Baidyapur	To assist the O. C Baidyapur	9733035277
14	Bhaskar Bhattacharya	S.A.E	Habibpur	O.C of Bulbulchandi G.P	7001822996
15			Bulbulchandi	To assist the O. C Bulbulchandi	
16	Rabin Chakraborty	S.A.E	Habibpur	O.C of Sreerampur G.P	
17	Peter Murmu	Secretary	Sreerampur	To assist the O. C Sreerampur	
18	Swapan Arya	F.E.O	Habibpur	O. C of Rishipur G.P	9800833033
19	Atenu chakraborty	Secretary	Rishipur	To assist the O. C Rishipur	9434682708
20	Nabini Das	Deputy Sec.	Habibpur	O.C of Aiho G.P	9733114885
21	Satyen Haldar	Sahayak	Aiho	To assist the O.C Aiho	9734942998
22	Ashok Sarkar	S.E.O	Habibpur	O.C of Dhumpur G.P	9735058683
23		E.A	Dhumpur	To assist the O.C Dhumpur	
24	Palash Ghosh	B.I.O	Habibpur	O.C of Jajoil G.P	6296044715
25	Biswajit Adhikary	E.A	Jajoil	To assist the O.C Jajoil	9733432196
26	Sujit Kr. Lal	A.A.E.O	Habibpur	O.C of Aktail G.P	9434193323
27	Goutam Mandal	Secretary	Aktail	To assist the O.C Aktail	9933520360
28	Anisur Rahaman	A.P.O	Habibpur	O.C of Kanturka G.P	
29	Bhaskar Roy	E.A	Kanturka	To assist the O.C Kanturka	

**REQUIREMENT OF GAS CUTTER, CRANE JCB MACHINE, EARTH MOVER, SAW MILL, BUS
TRUCK/407/LORRY**

ITEM	NAME OF THE OWNER	MOBILE NO.
Gas Cutter	Sri Jiban Saha	9434420955
Crane	Sri Malay Kumar Sarkar Md. Ansar, Malda	9434420955 9434057554
JCB Machine & Earth Mover	Sri Bholá Ghosh	9733361219
Saw Mill	Sri Purnendu Kundu	8972208493
Bus	Sri Purnendu Kundu Sri Shankar Bhagat	8972208493 9434206537
TRUCK/407/LORRY	Sri Prakash Prosad	9434154408

Contingency Plan : Kaliachak-I Dev Block

Socio-economic Profile of Englishbazar Block:

1) Total Geographical Area (Hec): 106.6 sq km

2) Boundary : North – English Bazaar Municipality

South – Kaliachak - III Block & Kaliachak - II Block

East – English Bazar Municipality, Kaliachak – II Block & Bangladesh

West – Kaliachak - II Block

3) Regular rainfall:	853 mm
4) Net Area under cultivation (Hec.) :	17071
5) Net Cropped Area (Hec) :	9571
6) Net Irrigated Area (Hec) :	7500
7) Area under pasture orchard etc. (Hec) :	900
8) Forest land (Acres) :	Nil
9) Gram Panchayat:	14 Nos.
10) No. of Village :	151 nos.
11) No. of Mouzas:	66 Nos.
12) Population as per Census 2011:	3,92,439
13) No. of Rescue Centre:	105
14) No. of H.S School:	04
15) No. of High School:	10
16) No. of Jr. High School:	02
17) No. of Primary School:	109
18) No. of High Madrasah:	05
19) No. of College:	01
20) No. of Rural Library:	03
21) No. of Block Pry. Health Centre:	01
22) No. of PHC:	03
23) No. of Sub Centre:	42
24) No. of MSK:	13
25) No. of SSK:	52
26) No. of Post Office:	03 (BOP – 29)
27) Name of the Important Rivers:	The Pagla and Bhagirathi

Vulnerable Gram Panchayat & Embankment / Sluice

Name of the Vulnerable Gram Panchayats:

- 1) Alinagar 2) Kaliachak – I 3) Kaliachak – II 4) Alipur – I
5) Alipur – II 6) Mozampur 7) Silampur – I 8) Silampur – II
9) Nawda Jadupur 10) Sujapur 11) Jalalpur 12) Gayeshbari
13) Bamongram Mosimpur 14) Jaluabadhal

Vulnerable Points on Embankments / Sluice:

- 1) Khaltipur in Silampur – II G.P
2) Tetrutola Points in Kaliachak – I GP
3) Bathan in Kaliachak – I GP

Name of Vulnerable and very Vulnerable Villages (G.P wise):

Rustamnagar ,Jothparam Noornagar (**Alinagar GP**)
Tetrutola , Ramasankartola (**Kaliachak – I GP**)
Balupur , Nagirpur(**Sujapur G.P**)
Kadamtola , Purba Krishnapur (**Jaluabadhal G.P**)

Assessment of area Prone to River Erosion:

- Rustamnagar ,Jothparam Noornagar (**Alinagar GP**)
- Tetrutola , Ramasankartola (**Kaliachak – I GP**)
- Balupur , Nagirpur(**Sujapur G.P**)
- Kadamtola , Purba Krishnapur (**Jaluabadhal G.P**)

Gram Panchayat level

Sl No.	Name of Gram Panchayat	Contact Person	Mobile No.
1	Alinagar	Proadhan	8768004553
		UpaProadhan	9733189761
		Executive Assistant	7797902625
2	Kaliachak – I	Proadhan	9733191739
		UpaProadhan	9735072616
		Executive Assistant	7797902625
3	Silampur – I	Proadhan	9647372425
		UpaProadhan	98641863053
		Executive Assistant	9775882376
4	Silampur - II	Proadhan	9733431333
		UpaProadhan	9564654787
		Executive Assistant	9635191260
5	Nawda Jadupur	Proadhan	9735778030
		UpaProadhan	8926605880
		Executive Assistant	9932025227
6	Jalalpur	Proadhan	9434411530
		UpaProadhan	9733339516
		Executive Assistant	8670429298
7	Bamongram Mosimpur	Proadhan	9800916530
		UpaProadhan	9564243811
		Executive Assistant	7872593731
8	Jaluabadhal	Proadhan	9679167933
		UpaProadhan	9734034630
		Executive Assistant	7872593731
9	Mozampur	Proadhan	7551876782
		UpaProadhan	9734611092
		Executive Assistant	9564154134
10	Alipur - II	Proadhan	7908138427
		UpaProadhan	8116289010
		Executive Assistant	9641035968
11	Alipur – I	Proadhan	9434641279
		UpaProadhan	9733219607
		Executive Assistant	9564154134

12	Gayeshbari	Prodhan	9563062616
		UpaProdhan	9734789360
		Executive Assistant	9593810714
13	Sujapur	Prodhan	9614220792
		UpaProdhan	9733248706
		Executive Assistant	9593810714
14	Kaliachak - II	Prodhan	6295221124
		UpaProdhan	6294228958
		Executive Assistant	9733413877

Block Level:

Block Disaster Management Committee

1	Sabhapati, Kaliachak – I Panchayat Samity	Chairman	9641362743
2	Block Development Officer, Kaliachak – I	Convener	7719360743/03512244258
3	Karmadhyaksha, Shishu-o-NariUnnayan, Janakalyan-o-Tran SthayeeSamity	Member	7076571671
4	Jt. Block Development Officer, Kaliachak – I	Member	9073938571
5	Block Land & Land Reforms Officer	Member	7719360780
6	Block Medical Officer of Health	Member	8101347606
7	Block Livestock Development Officer	Member	9434301028
8	Assistant Director Agriculture	Member	9735234483
9	SI of School	Member	8926360250
10	Child Development Project Officer	Member	8436593699
11	Inspector-in-charge, Kaliachak Police Station	Member	244310/9083270309
12	Baliadanga Yuba Kallan Samittee	Member	8918425422

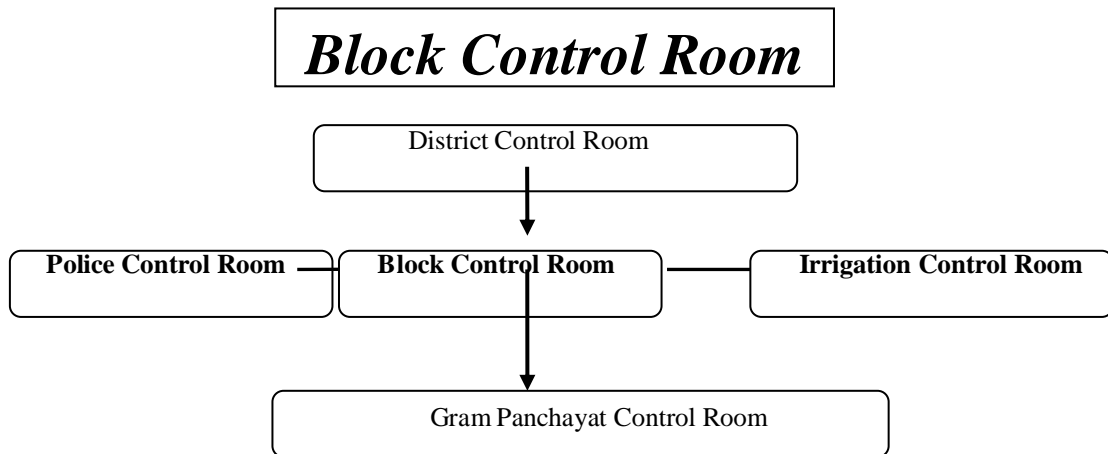

Quick Response Team at Block Level

Name of the Officers & Staffs	Designation	Contact No	Duty Allotted	
Sandip Ghosh	B.D.O, Kaliachak - I	9434738341	Over all In- Charge	
Riya Chakraborty	Jt. BDO, Kaliachak -I	9073938571		
Sabyasachi Mukharjee	IBCW	9083290332		
Gobinda Ch. Sarkar	SAE	9476288363		
Ujjal Das	SAE	9614510099		
Subhajit Poddar	T.A	7797951956		
Pradip Gupta	T.A	9434422242		
Shuvra Das	A/C	9932870458		
Sujoy Biswas	APO	9609218128		
Debabrata Biswas	FFA	8981763224		
Md.Israil Momin	Data Manager KP	8906697487		
Gouranga Sinha	A.H.C	9733165197		
Md.Mazharul Islam	A/C Clerk	9735747375		Cash Section
Nanda Kr. Sarkar	Cashier	9733152037		Report Section
Ziaur Rahaman	JE (RWS)	9749333102		
Tilok Sen	D.E.O, M.D.M	9832402888		
Kousik Ghosh	D.E.O	9332653220	Strong Room	
Md.Juber Hossain	G-D.A	8967615552		
Aynul Hoque	S.E.O	9733083304		
Abhilash Mandal	LDA	9734936463		
Gopal Ch. Mandal	P.S ,SHG & SE Dept.	9734222286		
Amalendu Pal	P.P	9733209762		

Name of the Officer/Officials engaged at Gram Panchayat Level for Quick Response:

Sl.No.	Name of the G.P	Name of the Officers & Staff	Phone No
1	Alinagar	Md.Selim Sk, E.A Asem Mahata, N.S , Md.majtuba Ali , Secretary Najrul Islam , Sahayak Pravash Ch. Das . GPK Md.Hedayetullah , GPK	7797902625 9434213477 8617684470 9733130048 9932531964 9735090234
2	Kaliachak - I	Md.Selim Sk, E.A Sutana Karmakar , N.S Md.Aziz Khan , Secretary Md.rafiq Sk, Sahayak Manob Kr. Roy, GPK Shib Narayan Pramanik, GPK Md.Rojul Islam , GPK	7797902625 9832535345 9832358485 9775495211 9932929380 8170970826 8768942746
3	Silampur – I	Atiur Rahaman , NS , Sanjib Kr. Misra Secretary Md.Jhihaj , Sahayak Md.Motiur Rahman , GPK Raj Kr.Basak , GPK	9733074710 9635191260 9734108922 8436391351 7602310966
4	Silampur - II	,EA BiplabTribedi, NS Suman Kr. Das, Secretary Koushik Mandal, Sahayak Goutam Mandal, Sahayak Subrata Das, GPK Nityananda Das, GPK	9474346485 9475093479 9434206961 9434186121 9609956154 7501021503 9593967265 9735098454
5		Bikash Ch. Das, E.A	9932025227

	Nawda Jadupur	Radhesham Barma, N.S Md.Bareque Ali, Sahayak Bappa Kr. Pal, GPK Motiur Hossain , GPK	9734163449 9933494662 7384171041 9734171018
6	Jalalpur	Mobarak Sk, EA Dalim Sk, NS Manab Mitra, Secretary Goutam Sarkar, Sahayak Md.Jakkar Ali, Sahayak Panchanan Das, GPK Md.Sajahann Ali, GPK	8670429298 9800908755 9614037268 9733303057 9593662758 8972385424 9733130218
7	Bamongram Mosimpur	Tanmoy Mandal , E.A Sandipan Das, N.S Md.Selim Sk, Sahayak Nipu Sarkar , Sahayak Md.Mohsin Ali, GPK Niladri Biswas, GPK	7872593731 7001305376 9563518966 9002266627 9733038816 9002266627
8	Jaluabdhal	TanmoyMandal,EA Sk,NS Md.Rejaul Hossain, Secretary Unus Ali, Sahayak AninditaJha, Sahayak Md.selim Ali, GPK	7872593731 9800908755 9732530961 9735368489 9734251441 9609251504
9	Mozampur	Emamul Hoque, E.A Jakir Sarif,NS Babul Akhtar , Secretary Ruhul Islam , GPK	9564154134 9593955071 9609745050 9734905908
10	Alipur - II	Muklesur Rahman , EA Palash Kr. Mandal, NS Md.Minarul Hoque, Secretary Rumman Ali, GPK	9641035968 7872918035 9593992070 9800471768
11	Alipur - I	Emamul Hoque, EA Palash Kr. Mandal, NS Anup Dutta, Secretary Sitesh Basak, GPK	9564154134 7872918035 9851482925 8906250229
12	Gayeshbari	Dost Mahammad , EA	9593810714
		Sushma Khatun , NS	8927655078
		Kingsuk Saha, Secretary	9475444347
		Dipti Das, GPK	7407158861
13	Sujapur	Dost Mahammad , EA	9593810714
		Amal Das, NS	9434231943
		Md.Eshamuddin ,Secretary	7585869250
		Chanchala Mandal , GPK	9800804377
		Md.Hakimuddin , GPK	9832053651
14	Kaliachak - II	Abul kalam Azad, EA	9733413877
		Prosenjit Sarkar , NS	8617625002
		Manwar Hossian ,Secretary	9434954838
		Swapan Kr. Chowdhury,GPK	9734057046

List of Trained Civil Defence Volunteers (Collected from SSOI, CD, Malda):

Sl No.	Name	Address	Mobile No.
1	Washim Sk	Jalalpur, kaliachak , Malda	7363028870
2	Alamin Sk	Jalalpur, kaliachak , Malda	8001791718
3	Muktarul Sk	Nornagar, kaliachak , Malda	9679064056
4	Md.Kutubuddin Sk	Jalalpur, kaliachak , Malda	9933884353
5	Md.Sarwar Jahan	Dharara, kaliachak , Malda	8768713863
6	Md.Tusar Ali	Fatekhani, kaliachak , Malda	9932488314
7	Md.Ahad Ali	Jalalpur, kaliachak , Malda	8159994122
8	Md.Hasanur Sk	Noornagar, kaliachak , Malda	9647792385

Contingency Plan : Kaliachak-II Dev Block

Introduction.

Among 15 Blocks in Malda, Kaliachak - II Development Block is one of the vulnerable Blocks in the shadow of mainly Flood and Erosion.

The Block has an area 209.17 sq.k.m. and comprises of nine Gram Panchayats. The total population of this Block is 208089 (as per 2011 Census Report). The livelihood of the majority of population depends on Agriculture, Horticulture and Cultivation of Polu.

The Block is Prone to Flood. The main rivers are the Ganges , the Pagla, the Bhagirathi. Among nine Gram Panchayats the most vulnerable Gram Panchayats are ,Bangitola , Uttar Panchanandapur - I , Uttar Panchanandapur - II , Rajnagar&Hamidpur.

The Block shows the sign of severe problems due to Erosion caused by the Ganges. As Flood , Erosion prevail, a large number of population faces tremendous hardship.

To mitigate the emergent situation because of Flood , Erosion or other Natural Calamities , like Pre - monsoon Cyclone , Drought (rarely occurred)and Accidental Fire (if any) ; DISASTER MANAGEMENT PLAN, 2020 - 2021 has been prepared on the basis of various relevant points.

Hazard , Vulnerability , Capacity & Risk Assessment (HVCRA)

Name Of The Much Vulnerable G.P. And Villages

Among 317 Villages many villages are vulnerable in the perspective of Flood, and there condition worsened when Flood rules over them. Such villages are listed below.

Sl .No.	Gram Panchayat	Name of the Villages	Remarks
1	Uttar Panchanandapur-I	a) Dalboxtola , b) Ramlaltola (Partly) , c) Loharditola , d) Purba Sultantola , e) Laskoritola , f) Paglaghat Bus Stand , g) Jinerditola , h) Nasarattola	Water - logged in the Year 2011 2013 , and 2015 2016 ,2019
2	Uttar Panchanandapur-II	a) Dhelfora , b) Jitnagar , c) Jugaltola	Water - logged in the Year 2011 ,2019

3	Bangitola	a) Jote Kostury , b) Mahadevpur , c) Bintola , d) Sadipur , e) Gosaihat , f) Chowdhurytola g) Chhatiantola , h) Sakullapur, i)Majiasaran	Water - logged in the Year 2011, 2013, 2014 2015 and 2016 ,2019
4	Hamidpur	a) Shibutola , b) Etwaritola , c) Shripur Colony , d) Piaritola (East & West) , e) Tofi , f) Mathabhanga , g) Jatintola , h) Chumkitola , i) Chethrutola , j) Khatiakhana Char , k) 8 no. Spar Bundh	Water - logged in the Year 2011 , 2013 2015 and 2016 ,2019
5	Rajnagar	a) Nayagram Model , b) Bromottar	Water - logged in the Year 2011, 2013 and 2016 ,2019

OPERATION SECTION

Sectional Name	Controlling Official	Designation	Contact No
Staging Area	Santu Pramanik	S A E (A I)	9475054153
	Biswajit Bhattacharjee	S A E (B P)	9435728835
Response Branch	Monojit Biswas	CCT	9749552357
Divisional (Geographical)	Md. Anisur Rahman	DEO (MDM)	9593109571
Group (Functional single Resource ,Task Force /Strike Team	Fitu Sk	DRMP .MEMBER	9733207278
Transportation Branch (Road)	Sanjib Kumar Saha	Chowkider RLI	9851639567
Transportation Branch (Rail)	Sachipati Jha	DRMP .MEMBER	9647846848
Transportation	Shankar Saha	DRMP .MEMBER	8670280470

Branch (Water)			
Transportation Branch (Air)	Dipanjan Das	DM (Kanyashree)	9679899227

Planning Section.

Section Name	Controlling Officer	Designation	Contact No
Resource Unit	Omioranjan Roy	C I	8670390282
Situation Unit	Joyesh Sinha	D E O	9734192631
Docomentation Unit	Masiur Rahman	U D A	7872805449
Demobilization Unit	Sk Ayum Ali	U D A	9933651966

Logistic Section.

Section Name	Controlling Officer	Designation	Contact No
Service Branch Communication Unit	Md . Kalander Ali	A P O 9MGNREGS)	7872231033
Service Branch (Medical Unit)	Akib Khan	B C W	9883777903
Service Branch (Food Unit)	Md. Mahatabuddin Ali	Supervisor,	7908768946
Support Branch (Resource providing unit)	Debashish Sarkar	A C H C	9434732150
Support Branch (Facility unit)	Prodyut Mandal	U D A	834820011
Support Branch (Ground support unit)	Sudipta Chowdhury	L D A	9851900887
Finance Branch (Time Unit)	Abdul Majed Ali	A A E O	6296552767
Finance Branch (Compensation/ClaimUnit)	Nisit Kundu	CASHIER (BLOCK ESTABILISHNENT SECTION	9832484874
Finance Branch (Procurement Unit)	Rasidul Khayer	CASHIER CUM STORE KEEPER	9647766412
Finance Branch (cost Unit)	Monoj Gupta	CCT	9851274543

Preparedness Measures

[BLOCK CONTROL ROOM]

SL NO.	NAME	DESIGNATION	MOBILE NUMBER
1.	Sanjay Ghising	B,D,O	7719360744
2.	Subrata Mallik	Joint B.D.O.	9830112992

3.	Rofiqul islam	B.D.M.O. in charge	8617064608
4.	Ria Dinda	F.E.O.	8420181265
5.	Mithu Karmakar	B I O	9641356603
6.	Monojit Biswas	C.C.T.(P.S.)	9749552357
7.	Prodyut Mandal	U.D.C.	834820011
8.	Akib Khan	B.C.W	9883777903
9.	Abdul Majed Ali	A A E O	6296552767
10.	Sudipta Chowdhury	L D A	9851900887

Country Boat & Mechanised Boat Deployment details with authentic contact no. & name of Boat man

Sl. No.	Name of Boat Owner	Contact No.	Gram Panchayat	Type of Boat	Tagged Official
1	Ghanashyam Mandal	9563831634	Hamidpur G.P	Small size bhutbhuti	Ashok Saha, Secretary, Hamidpur G.P.,7908038563
2	Sanatan Mandal	9734957349	Hamidpur G.P	Small size bhutbhuti	
3	Khalek Sk	7872518641/ 9933124494	Rajnagar G.P.	Small size bhutbhuti	Md DaudHossein, EA, RajnagarG.P.,9733 396998
4	Sattar Ali	9733146058	Uttar Panchanandapur-I G.P.	Small size bhutbhuti	Md. MobarokSk, EA, Uttar Panchanandapur-I G.P.,9932611583
5	RofikSk	9134665949	Uttar Panchanandapur-I G.P.	Small size bhutbhuti	
6	SaidulHoque	9563262536	Uttar Panchanandapur-I G.P.	Small size bhutbhuti	
7	EnamulHoque	9733018485	Uttar Panchanandapur-I G.P.	Small size bhutbhuti	
8	Bharat Mandal	7076582522	Uttar Panchanandapur-I G.P.	Small size bhutbhuti	
9	NuhuSk	9563659861/ 9735089005	Uttar Panchanandapur-I G.P.	Small size bhutbhuti	
10	PoltuSk	9733108894	Uttar Panchanandapur-II G.P.	Small size bhutbhuti	

11	UjirSk	9733108894	Uttar Panchanandapur-II G.P.	Small size bhutbhuti	Panchanandapur-II G.P.,9733465672
12	TapanMandal	8158082181	Bangitola G.P.	Country boat(Rowing)	Abdul NaserDewan, EA, Bangitola G.P., 9609781141
13	RajkumarMandal	7076048171	Bangitola G.P.	Country boat(Rowing)	
14	RatanMandal	8016852528	Bangitola G.P.	Country boat(Rowing)	
15	DilipMandal	8016852528	Bangitola G.P.	Country boat(Rowing)	
16	BabluMandal	9734655495	Bangitola G.P.	Country boat(Rowing)	
17	Krishna Mandal	9733221992	Bangitola G.P.	Country boat(Rowing)	

**Co-ordination Mechanism for implementation of DDMP
Kaliachak-II Dev,Block,Malda**

Sl. No.	At Block Level Staffs	Name(Designation)	Mobile
A.	Sabhapati, Panchayat Samity	Tinkur Rahaman Biswas	9733059116
B.	Block Development Officer	Sanjoy Ghising	7719360744
C.	Karmadhakshya,Sishu-o-nari Unnayan Janakalyan-o-Tran sthayee Samity of Panchayat Samity	Dilnara Bibi	9641894031
D	Block Disaster Management Officer in charge	Rofiqul Islam	9641894031
E.	Officer in – Charge Mothabari Police Station	Bitul Paul	9083270323

GRAM PANCHAYAT LEVEL STAFFS

Sl. No.	Name of G.P.	Name of Prodghan and Upo-Prodhan	Contact
1.	Bangitola G.P	Mst. Santara Khatun(Prodhan)	7407101568
		Putul Chowdhury(Upo-Prodhan)	8170956013
2.	Uttarpanchanandapur -I G.P.	Ruiya Bibi(Prodhan)	9851870451
		Abdul Hoque(Upo-prodhan)	9736060150
3.	Uttarpanchanandapur -I I G.P.	Anjana Mandal Sarkar(Prodhan)	9735063177
		Santana Ghosh(Upo-prodhan)	9735551054

4.	Rathbari G.P	Sahanara Khatun (Prodhan)	963553201
		Sanjib Swarnakar(Upo-prodhan)	9593225489
5.	Gangaprasad G.P	Amiul Islam(Prodhan)	9733238286
		Mina Mandalr(Upo-prodhan)	9800846120
6.	Uttarlaxmipur G.P..	Nur Asmin Khatun(Prodhan)	9733129762
		Basudev Mandal(Upo-prodhan)	7407052355
7	Mothabari G.P	Mosa .Nilufa Iyasmin (Prodhan)	6295151675
		Sahidul Sekh(Upo-prodhan)	9775461810
8	Hamidpur G.p	Jakera Bibi(Prodhan)	9593754677
		Parul Mandal (UpoProdhan)	9734330642
9	Rajnagar G.P	Dhani Rani Mandal(prodhan)	9775412588

Name Of The Officer/Officials Engaged At Gram Panchayat Level.

Sl. No.	Name of the G.P.	Name of the Officers & Staffs	Contact No
1.	Bangitola G.P	Rofiqul Islam B D MO in Charge	8617064608
		Abdul Naser Dewan E.A	9609781141
		Partha Dutta Secretary	9733010282
		SadhanKumarMandal Nirma Sahayak	9735913493
		Sunil Chandra Mandal	8016274625
		Pijush Mandalk	7063399333
2.	Panchanandapur – I G.P	Akib Khan BCW inspector	9883777903
		Md. Mobarak Hossain E.A	9932611583
		Priyaranjan Das N.S	9733264081
		Kanak Kumar Mandal Secretary	9733095438
		Masidur Rahman Sahayak	9832747297
		Sadiqul Islam Sahayak	9734993363
3.	Panchanandapur – I I G.P	Ria Dinda F.E.O	8420181265
		Wasef Ali Chowdhury N.S	8617883616
		Nazrul Islam E.A	9733465672
		Shyamal Kr. Das Secretary	9649343725
		Tunu kumar Sanghi Sahayak	9564644752
		Jalpana Saha	8/145301371

Name of the Officers/Officials engaged at Gram Panchayat Level

Sl. No.	Name of the G.P.	Name of the Officers & Staffs	
4.	Rathbari G.P	Mithu Karmakar B I O	9641356603
		Sanghati Mukherje E.A	9434406966
		Kanak Kumar Kundu N.S	9474163078
		Goutak Majumdar Sahayak	9434245738
		Md. Badiruddin Sahayak	9733419540
		Subhas Chandra Mandal GPK	7872871566
5.	Mothabari G.P	Masiur Rahman U D A	7872805449
		Md. Emadudin E.A	8327218031
		Jayan Chandra Mandal N.S	9474794995
		Binoy Kumar Ghosh Sahayak	9733189687
		Mrinal kumar Mandal secretary	9735935372
6	Uttarlaxmipur G.P	Santu Pramanik SAE (AI)	9475054153
		Kumarika Saha N.S	9563364335
		Manoj Sarkar Sahayak	9800849032
		Harun Al Rasid GPK	7797884582
		Hemonta Kumar ROY	9733460054
7	Hamidpur G.P	Omioranjan Roy C I	8670390282
		Subrata Kumar Upadhyay N.S	8967674975
		Asok Saha Secretary	8670129325
		Nousad Ali Sahayak	9734059871
		Md. Zeaul Hoque E.A	9735029874
8	Rajnagar G.P	Joyesh Singh DEO	9734192631
		Md. Daud Hossain E.A	9733396998
		Balu Roy Secretary	7384984211
		Shyamal Kumar Das N.S	9609982896
9	Gangaprasad G.P	Prodyut Mandal UDA	834820011
		Ahmed Reza E.A	9851905051
		Md. Torab Ali Secretary	7797874193
		Debashish Chowdhury N.S	9749633400
		Srimanta Kumar Roy GPK	9614119960
		Manoranjan Mandal GPK	8145831755

Sl. No.	Name of Ambulance Driver	Ambulance No.	Contact No.
1.	Bangitola RH(Fitu Sk)	NGO(WB/65/9103)	9733336030
2.	Anuarul Sk	WB/65B/9274	8768443077
3.	Anuarul Sk	WB/65/ 6560	8641055583
4.	Saukat Ali	WB/657709	947465683
5	Aktaar Alam	WB/65/9103	8641055583
6	Fatik Sk	WB/65C/0039	9775997524
7	Sultana Khatun	WB/ 65/9103	8641055583
8	Akhtar Alam	WB66B/7388	9679079434
9	Anikul Islam	WB/65B/9496	9733227209
10	Abdul Ajj	Wb /65C/2864	9749043089
11	Ujir Chowdhury	WB 65A/ 1046	9775614729
12	Anikul Islam	WB/66 W/8334	9733227209
13	Rintu Sk	WB/61A /4970	9775825283
14	Abdul Alim	WB 65C/3093	9733235713

List of Rural Hospitals , PHCs

Sl. No.	Name of Institutions	Contact No. (Mobile & Landline)	Bed Capacity	No of Doctors available	No. of Paramedical Staffs available
1.	Bangitola Rural Hospital	9564214594	30	4	2
2.	Mothabari Primary Health Center	8967453193	0	1	1
3.	Hamidpur Primary Health Center	9153438004	0	1	1

List of Drug Shops :

Sl. No.	Name of Shops (with location)	Contact No.	Remarks
1.	Fair shop not available (Bangitola RH)		
2.	Medicine Centre	9609919140	
3.	Akhi Medicine Centre	7602835669	
4.	Apple Medical Hall	9775461432	
5	AR Pharmacist	9800179207	
6	Good luck Medical	9932130497	
7	Sanu Medicine Corner	9775937089	
8	Popy Medical Hall	9474343383	
9	Richa Drug Agency	8116145775	
10	Baba Loknath Medical Hall	7278505690	
11	Raj Medicine Centre	9647888544	
12	Ahamed Medicine Centre	9733579605	
13	Bony Medicine Corner	9593965098	

List of Doctors available in the area :

Sl. No.	Name of Doctors	Contact No.	Specialized field
1.	Dr. Koushik Mistry(Bangitola RH)	8944953095	General Physician (BMOH)
2.	Dr. J Hoque(Bangitola RH)		General Physician (2 nd MO)
3.	Dr. Sudipta Sikdar(Bangitola RH)	7407988966	General Physician (MO)
4.	Dr. Jiaul Hoque(Bangitola RH)	7872060073	General Physician (MO)
5	Dr N Roy(Mothabari PHC)	8967453193	General Physician (MO)
6	Dr. N G Mandal (Hamidpur PHC)	9153438004	General Physician (MO)

H: List of NGOs :

Sl. No.	Name of NGOs	No. of volunteers (List to be enclosed)	Key person	Contact No	Specialized field
1.	Gangaprosad Rural welfare Society	8	Ansarul Mian	9733064256	SHG
2.	Sukurditola Rural Welfare society	7	Asraul Hoque	9733335923	Sanitation, Child Protection
3.	Meherapur Welfare society	7	Rabiul islam	8101289942	Sanitation
4.	Panchanandapur Binapani Rural Welfare Society	7	Krishna Mondal	9733277073	Sanitation

H: 1. Name and Contact no of NGO member

Sl.No.	Name of NGO	Member	Contact No.
1.	Sukurditola Rural Welfare Society	Asraul Hoque	9733335923
2.		Abul Kalam azad	9733126893
3.		Gautam Mondal	9733277073
4.		Shefali Khatun	9735047946
5.		Masidur Rahaman	9775974397
6.		Rigia Khatun	
7.		Hira Khatun	7548051137

H: 2.Name and Contact no of NGO member

Sl.No.	Name of NGO	Member	Contact No.
1.	Gangaprosad Rural Welfare Society	Md. Ziaur Rahaman	9734999776
2.		Ansarul Hoque	9733064256
3.		Tehera Begum	8670804645
4.		Md. Manjur Rahaman	9851813086
5.		Md. Samsuzzaman	7076741343
6.		Sabina Yasmin	9851183086

Contingency Plan of Kaliachak-III Dev Block

Assessment of Area prone to River Erosion & flood.

Sl.No	Name of the Gram Panchayat	Name of Vulnerable Village.	Remarks
1.	Birnagar-I	Lalutola,Dinutola,Chinabazar,	Erosion-2019-2020,Farakka barrage and river Ganges are the main factors.
2.	Birnagar-II	Sarkartola,Babupur,Guljartola,Mo llahtola,Mukundatola, Baguntola,	Water logged(flood like situation)- 2019-2020.Farakka barrage and river Ganges are the main factors.
3.	P/Sovapur	Khoyarpara,Chutpara,Golapmanda lpara,3&4no Colony,Badyanathpur,BechunSark arpara,Postofficepara,Parbodyanat hpur.	Erosion & Water logged(flood like situation)-2019-2020. Farakka barrage and river Ganges are the main factors.
4.	Krishnapur	Mondai,charsujapur, Bechan Mandal para,.	Water logged(flood like situation)- 2019-2020, Farakka barrage and river Ganges are the main factors.
5.	Bakhrabad	Sukdevpur,Sabdapur, Deonapur,	Water logged(flood like situation)- 2019-2020, Farakka barrage and river Ganges are the main factors.
6.	Kumbhira	Hazinagar,Mohanpur,Sukpara,	Water logged(flood like situation)- 2019-2020, Farakka barrage and river Ganges are the main factors.

Control room & crisis management team with contact no at block level.

Sl no	Name	Designation	Mobile No
1	GoutamDatta	BDO	9002203538
2	Sahanaj Begum	Savapati	8001245667
3	Mir SohelShakhawat	Jt. BDO	7908009502
4	Rajiv Samaddar	BDMO	9038579179
5	Mabia Bibi	Karmadhyakshya -Tran	9775954522
6	SouravDhabal	FEO	8621045935
7	Debaghya Samaddar.	Ins. BCW	9547843478
8	Jamsed ALI	SAE(B.P)	8436821576
9	BiplebenduBairagi	AP0	9093631160
10	Sujit Sarkar	RLI	9563920222
11	Abdul MarufMondal	CI	8001246597
12	Md. Hasib ALI	RLI	7001694240
13	Firdousara Begum	UDC	9733065380
14	DebasishSaha	Peon	9932968659
15	Aazamali	LDC	7550911239
16	Sahajad Ali	DLT	8001604872
17	Pata Mandal	Gro''D	9735067367

Local Police Station Baishnabnagar

1	Dipak Sarkar	Addl.S.P.	03512-244310
2	TridipPramanik	I.C.	9800894021

Control Room At GP Level**Name of the GP: Akandaberia**

Sl no	Name	Designation	Contact no.
1	Sarwati Mandal	Pradhan	9002280544
2	SaikatKarmakar	Executive Assistant	9733080228
3	NripenMurmu	Secretary	9734264709

Name of the GP: Bakhrabad

Sl no	Name	Designation	Contact no.
1	MastaraKhatun	Pradhan	9735935507
2	Samsuddin Ahmed	Executive Assistant	9836425385
3	EkramulHaque	Secretary	8768326379

Name of the GP: Birnagar-I

Sl no	Name	Designation	Contact no.
1	SimaHalder Roy	Pradhan	7365825351
2	MD. Emam Hossain	Executive Assistant	8918078220
3	Jagadishmondal	Secretary	8918726324

Name of the GP: Bedrabad

Sl no	Name	Designation	Contact no.
1	Rita Ghosh	Pradhan	9734171072

2	ObaidulHaque	Executive Assistant	8906293181
3	AbdurRahaman(In Ch.	Secretary	9734936140

Name of the GP: Birnagar-II

Sl no	Name	Designation	Contact no.
1	Soma Roy	Pradhan	9732477842
2	Sadikul Islam	E.A	9775067176
3	AshisDas,In Ch.	Secretary	9932672934

Name of the GP: Bhagabanpur

Sl no	Name	Designation	Contact no.
1	Mostaque Hossain	Pradhan	9733375855
2	Joharul Islam	EA	9734910580
3	Kalyan Sarkar	Secy.In charge.	9563238709

Name of the GP: Chariantapur

Sl no	Name	Designation	Contact no.
1	Sahanara Bibi	Pradhan	9733084746
2	Kalyansundar Sarkar	Secretary	9563238709

Name of the GP: Golapganj

Sl no	Name	Designation	Contact no.
1	Sabina Yesmin	Pradhan	8348809252
2	MdAbdussattar	Ea	7797004867
3	Debasish Mandal	Secretary	9933479653

Name of the GP: Krishnapur

Sl no	Name	Designation	Contact no.
1	Meser Ali	Pradhan	9733120153
2	Kalyan Mishra	EA	9733013009
3	Prabal ch. Sarkar	Secretary	8768002485

Name of the GP: Kumbhira

Sl no	Name	Designation	Contact no.
1	Bulbul sarkar	Pradhan	8967561031
2	Samsuddin Ahmed ,In Ch.	EA	9836425385
3	PranabMondal	Secretary	9734334547

Name of the GP: Lakshimipur

Sl no	Name	Designation	Contact no.
1	YoshadaKumariMondal	Pradhan	9064943278
2	MasidurRahaman	EA	8145360302
3	Abdul kalam Azad	Secretary	9434139865

Name of the GP: pardeonapur-Sovapur

Sl no	Name	Designation	Contact no.
1	SusmitaRabidas	Pradhan	9614642943
2	MasidurRahaman, In Charge,	EA	8145360302
.3	Ekramulhaque ,In Charge	Secretary	9733144632

Name of the GP: Sahabajpur

Sl no	Name	Designation	Contact no.
1	Beby Mandal	Pradhan	9547564309
2	TanmoyBasak	EA	7001865709
3	Satya Kr. Mondal	Sahyak	9800036756

Name of the GP: Sahabanchak

Sl no	Name	Designation	Contact no.
1	Riko Khatun	Pradhan	9939240624
2	SafiqulAlam	EA	9832535585
3	Biswa Das	Secretary	9733331791

CIVIL DEFENCE PERSONEL TO BE DEPLOYED FOR SEARCH & RESCUE WITH CONTACT NO.

Sl No.	Designation	Address	Contact No
1	Priyotosh Chowdhury	jotkosturi	8927895495
2	Sanju Mandal	Baishnabnagar	8159006147
3	Khairul Basar	PALGACHI	.-7384841625
4	AnshumanPramanik	Baishnabnagar	7797241257
5	Md Akbar Sk	Birnagar	7797290659
6	Md Hamid Ali	Birnagar	9732933312
7	Shyamali Mandal, (VT)	Lakshmipur-G.P.,Kaliachak-III	9547843478

8	Siddharta Ghosh,(VT)	Lakshmipur-G.P.,Kaliachak-III	9733163323
9	Farman Ali (V.T)	Krishnapur- G.P.,Kaliachak-III	9734221058
10	Sanjoy Mandal, (VT)	Krishnapur- G.P.,Kaliachak-III	8900589826
11	Shyamali Mandal, (VT)	Krishnapur- G.P.,Kaliachak-III	7002548752

List Of Country Boat Owners/Operators with size of Boat:

Sl No.	Name of Boat Owner	Name of GP	Contact no.
1	TashiruddinSk	p/sovapur	9083345253
2	Abdul Alim	P/sovapur	9734619535
3	Inalhaque	P/sovapur	8768374510
4	Bakkarsekh	p/sovapur	9153263569
5	Sanjay mondal	p/sovapur	9064727415
6	Shibumondal	p/sovapur	6295253802
7	ElahiSk	P.Sovapur	9775272061
8	Robiulhoque	P.Sovapur	8328794364
9	Abdul Sekh	P.Sovapur	8768030577
10	Azad sk	P.Sovapur	7319126031

11	Yusuf Ali `	p/sovapur	9775067215
12	Ramgati Chowdhury	p/sovapur	7797658896
13	Nandagopal Chowdhury	p/sovapur	7797429927
14	Raju Chowdhurya	p/sovapur	9735591663
15	Abu Kalam	p/sovapur	9732430218
15	Ashu Chowdhury	p/sovapur	8967772822
16	DilwarSk	Birnagar-I	9735070587
17	SikimSk	Birnagar-I	9735736170
18	AnjarulSk	Birnagar-I	9734990646
19	AlamgirSk	Birnagar-I	9734963011
20	RabiulSk	Birnagar-I	9734992198
21	DoulatSk	Birnagar-I	7797240679
22	RabiulSk	Birnagar-II	84369040679
23	KuddusSk	Birnagar-II	9564449967
24	SenaulSk	Birnagar-II	9734942915
25	IliasSk	Birnagar-II	8001251391

Important Telephone No. & Address of Resource Person of NGO & Social Worker

Sl No	Name of NGO	Name of Secretary	Contact No
1	16 Mile RDS	Md MaimulHoque	9002427747
2	Chak Seherdi Handicapped Society	MatrulSk	9733250711

Plan to Co-ordinate with PHE for safe drinking Water:

Sl No.	Name	Designation	Phone no.
1	Md jamshedAli	SAE, KCK-III	8436821576
2	Md Nurul Islam	SAE, BPC	9593863022
3	ARUP KR. PRAMANIK	MECH.	9733326747

Contingency plan of Englishbazar Dev Block

Stakeholders their responsibilities:

Block Development Officer: Block Development Officer is the Commandant of the Block in respect of Disaster Management. All the works related to rescue, relief distribution and rehabilitation are done as per his direct supervision.

Police: Police takes a major role in rescue operation, distribution of relief materials and maintaining Law & Order situation during disasters.

Inspector of Food Supplies: Inspector of Food Supplies takes a major role for arrangement of Food grains, Kerosene Oil etc. and maintaining liaison with the dealer points for maintaining PDS during disaster situation.

Irrigation Department: Maintenance and repairing of embankments in emergency basis.

Civil Defence: Civil Defence Volunteers help in rescue operation, distribution of relief articles during disaster situations.

Block Medical Officer of Health: Block Medical Officer of Health takes a major role to take emergency treatment facilities for the victims of any disasters and send Medical Teams to the disaster affected areas regularly and takes an important role to control the outbreak of any types of epidemic.

Block Livestock Development Officer: Block Livestock Development Officer takes major role for protection of live stock after disasters and arranges fodder, necessary vaccination for the cattles and runs regular vigil to the cattle's health.

Assistant Director of Agriculture: Assistant Director of Agriculture takes a major role in identifying the crop area damages and the affected farmers and takes an important role in giving Government Assistance to the identified farmers.

Child Development Project Officer: Child Development Project Officer takes an important role to run the ICDS Centres in alternate places to provide food to the children and pregnant women during the disaster situation.

PHE Department: PHE Department takes a major role to provide water pouches to the victims of disasters and takes a major roll for disinfecting the tube wells after flood period.

Electricity Department: Maintenance and Supply of electricity is an important issue which runs by the Electricity Department after any disasters.

Fire Services Department: This department takes an important role in disasters caused by accidental fire, earthquake etc.

Non Government Organisation: Non Government Organisations take major role in helping the administration in providing the joint rescue operation, relief distribution and to provide awareness campaign in the cluster areas of the society.

Socio-economic Profile of Englishbazar Block:

- 1) **Total Geographical Area (Hec):** 24632.59
- 2) **Boundary :** **North** – Old Malda Block & Ratua –II Block
South – Kaliachak - I Block & Kaliachak - II Block
East – English Bazar Municipality & Bangladesh
West – Manikchak Block
- 3) **Regular rainfall:** 1453 mm
- 4) **Net Area under cultivation (Hec.) :** 21417.86
- 5) **Net Cropped Area (Hec) :** 8955
- 6) **Net Irrigated Area (Hec) :** 6275
- 7) **Area under pasture orchard etc. (Hec) :** 8941
- 8) **Forest land (Acres) :** Nil
- 9) **Gram Panchayat:** 11 Nos.
- 10) **No. of Village :** 270 nos.
- 11) **No. of Mouzas:** 135 Nos.
- 12) **Population as per Census 2011:** 2,74,103
- 13) **No. of Rescue Centre:** 169
- 14) **No. of H.S School:** 04
- 15) **No. of High School:** 33
- 16) **No. of Jr. High School:** 01
- 17) **No. of Primary School:** 139
- 18) **No. of High Madrasah:** 02
- 19) **No. of College:** 04
- 20) **No. of Rural Library:** 09
- 21) **No. of Block Pry. Health Centre:** 01 (Milki BPHC)
- 22) **No. of PHC:** 02 (Mahadipur & Chandipur)
- 23) **No. of Sub Centre:** 33
- 24) **No. of MSK:** 06

- 25) No. of SSK: 25
- 26) No. of Post Office: 22
- 27) Name of the Important Rivers: The Ganges, Kalindri and Mahanand

Vulnerable Gram Panchayat & Embankment / Sluice

Name of the Vulnerable Gram Panchayats: 1) Sovanagar, 2) Milki, 3) Binodpur, 4) Narhatta, 5) Fulbaria, 6) Kazigram, 7) Jadupur-II, 8) Kotwali, 9) Partly Amrity, 10) Partly Mahadipur, 11) Partly Jadupur-I

Vulnerable Points on Embankments / Sluice: 1) Sagardighi in Kazigram G.P

2) Bramjan Points in Narhatta GP

3) Kadubons in Narhatta GP

4) Itakhola Sluice in Narhatta GP

5) Bongapoint in Narhatta GP near Nagrai point

6) Laxmighat point near Masjid

7) Babu Mia point

8) Khaskole Sluice gate & Sadipur point in Binodpur GP

9) Hatkhola, Atgama point in Milki GP

10) Gosainpur Point & Sadipur Point in Binodpur GP

11) JotePrithi point in Kazigram GP

12) Domohini points in Kazigram GP

13) Kanchantar to Kumarpur road point in Jadupur-II GP

14) Bidhannagar barrage point

15) Bhabanipur to Kalindri in Sovanagar GP

16) Kalindridare point in Sovanagar GP

17) Nahadiradra point in Sovanagar GP

18) Chandipur in Sovanagar GP

19) Satichora point in Kotwali GP

20) NutunNagharia in Fulbaria GP

21) Kamaltipur&Mohanpur under Sovanagar GP

22) Khasipara&Kawakhand under Milki GP

Khaskhole, Khasipara&Kawakhand(**Milki GP**)
Mohanpur&Kamaltipur(**Sovanagar GP**)
Nagharia, NatunNagharia(**Fulbaria G.P**)
Itakhola, Tekra (**Narhatta G.P**)
Satichura Colony, Bridge Colony (**Kotwali G.P**)

Institutional arrangements for Disaster Management (DM):**Gram Panchayat level:**

Sl No.	Name of Gram Panchayat	Contact Person	Mobile No.
1	Binodpur	Prodhan	9679357833
		UpaProdhan	9434920786
		Executive Assistant	9732647669
2	Milki	Prodhan	9593850793
		UpaProdhan	9593306922
		Executive Assistant	9474017510
3	Kazigram	Prodhan	9733227311
		UpaProdhan	9733018841
		Executive Assistant	9475093479
4	Jadupur-I	Prodhan	7098688476
		UpaProdhan	9434206911
		Executive Assistant	9800142142
5	Jadupur-II	Prodhan	9564955252
		UpaProdhan	7797278587
		Executive Assistant	9733134873
6	Fulbaria	Prodhan	9733237899
		UpaProdhan	9550827313
		Executive Assistant	9734905143
7	Narhatta	Prodhan	7699883633
		UpaProdhan	9647879823
		Executive Assistant	9434455964
8	Kotwali	Prodhan	8653714666
		UpaProdhan	9064793298
		Executive Assistant	9474775799
9	Amrity	Prodhan	8371852980
		UpaProdhan	9734135501
		Executive Assistant	9475391361
10	Sovanagar	Prodhan	9734192907
		UpaProdhan	9593833252
		Executive Assistant	9635207929
11	Mahadipur	Prodhan	8436014690
		UpaProdhan	9933537649
		Executive Assistant	9851023125

Block Level:**Block Disaster Management Committee**

1	Sabhapati, English Bazar Panchayat Samity	Chairman	7063133804/252327(O)
2	Block Development Officer, English Bazar	Convener	7719360742/252297(O)
3	Karmadhyaksha, Shishu-o-NariUnnayan, Janakalyan-o-Tran SthayeeSamity	Member	8086628299
4	Jt. Block Development Officer, Englishbazar	Member	8436533210/9232470435

5	Block Disaster Management Officer	Member	7407908299
6	Block Land & Land Reforms Officer	Member	8961287456
7	Block Medical Officer of Health	Member	274699/7548072470
8	Block Livestock Development Officer	Member	9800086865
9	Assistant Director Agriculture	Member	9614250512
10	SI of School	Member	9474476645
11	Child Development Project Officer	Member	9330246141
12	Inspector-in-charge, E.B Police Station	Member	252071/9083270308
13	Block Welfare Officer	Member	9062716025
14	N.G.O Krishna Kali Vocational Training Centre	Member	9932379083

List of Community Facilitators (C.Fs)

Jadupur-I Gram panchayet			
Sl. No.	SASAD NO.	NAME OF THE Community Facilitators	cont. No.
1	I	MOUSUMI KHATUN	9800905733
2	I	MARIUM ARA	8537875471
3	II	AMBERA KHATUN	8536023649
4	II	JANNATUN KHATUN	7407823908
5	III	FARIDA YESMIN	9093482443
6	III	SELIMA KHATUN	9733150463
7	IV	SABIRAN BIBI	9609813012
8	IV	SABINA KHATUN	9593550769
9	V	RADHA RANI SARDAR	9734771038
10	V	TOMA GHOSH	7872029541
11	VI	MAMPI MANDAL	7384223288
12	VI	PAPIYA PAL	9614710652
13	VII	SOLEHA KHATUN	9002592208
14	VII	MANUARA BIBI	8343022108
15	VIII	SANAKA DAS	7583908239
16	VIII	AJMIRA KHATUN	9775377165
17	IX	FATEMA KHATUN	8345892276
18	IX	TUMPA KHATUN	7865864423
19	X	MITHU CHOWDHURY	9609843944
20	X	KRISHNA MANDAL	9933079317
21	XI	RAKHI MANDAL(DAS)	8906385157
22	XI	PUTUL DAS	8158824978
23	XII	MOHUMUDA BIBI	9614272021
24	XII	SAJINA KHATUN	9503643522

Jadupur- II Gram panchayet			
Sl. No.	SASAD NO.	NAME OF THE Community Facilitators	cont. No.
1	I	JOSADA GHOSH	9609703922
2	I	FULA HALDAR	7602653782
3	II	GOURI GUPTA	9932951797
4	II	MAMONI SARKAR	8001924166
5	III	BABITA MANDAL	9735285069
6	III	DALI MANDAL	9474796279
7	IV	MINOTI MANDAL	
8	IV	SHIBANI MANDAL	9474729972
9	V	SIMA BIBI	7797984259
10	V	ANIMA KHATUN	9609428366
11	VI	ALOKA MANDAL	9735702148
12	VI	ASHA MANDAL	9647020684
13	VII	WAHIDA BIBI	7584028317
14	VII	LESANUR KHATUN	9593742940
15	VIII	MOLINA KHATUN	8670763415
16	VIII	ARINA KHATUN	7602985771
17	IX	CHANDANA DAS	9775420521
18	IX	SAGIRA BIBI	9593929510
19	X	ANJURA BIBI	7797995228
20	X	BEBI BIBI	7797857391
21	XI	RUNA BIBI	7407061465
22	XI	FIRDOUSHI BIBI	8116064551
23	XII	DALI DAS	8967556592
24	XII	TUMPA GHOSH	9932054239
25	XIII	NAMITA HALDAR	8116543945
26	XIII	MALATI HALDAR	7407160439

Kazigram Gram panchayet

Sl. No.	SASAD NO.	NAME OF THE Community Facilitators	cont. No.
1	I	SUPRITI UPADHYA	9593539348
2	I	JHARNA MANDAL	9593816575
3	II	BINA MANDAL	8116732439
4	II	ARCHANA MANDAL	9733234609
5	III	BINA MANDAL	9641493481
6	III	MALLIKA MANDAL	9775812938
7	IV	RAKHI PRAMANIK	9733112740
8	IV	BAKUL RANI MANDAL	9732046252
9	V	PINKI SAHA	8145230065
10	V	RUMA DAS	8370805210
11	VI	SABRUNA BIBI	9593905521
12	VI	USHA MANDAL	9776390330
13	VII	SUNITI BASAK	9647812924
14	VII	MANJANA GHOSH	

15	VIII	LATIKA GHOSH	7872230960
16	VIII	KALYANI MANDAL	9733270740
17	IX	NAMITA RAZAK	9734597003
18	IX	CHANDANA MANDAL	9647628789
19	X	KABITA MANDAL	9851016011
20	X	PALI RANI SAHA	9851890264
21	XI	CHANCHALA MANDAL	9734962532
22	XI	DALI BIBI	8906108282
23	XII	DALI DAS	8016834975
24	XII	SAHARA BIBI	9679393251
25	XIII	CHANDANA RAJAK	9002932984
26	XIII	TAPASI BASAK	9932541025
27	XIV	SHYAMALI DAS	9775200776
28	XIV	SAMAPTI GHOSH	7407473861
29	XV	SUNITI MANDAL	9153899814
30	XV	CHADNI BIBI	9609767423
31	XVI	MANJILA BIBI	9733017128
32	XVI	JAKIRA BIBI	9735292934
33	XVII	ARATI BISWAS	8670317596
34	XVII	REKHA MANDAL	9593878485
35	XVIII	SUSHUMA MANDAL	9083203764
36	XVIII	JOTSNA GOSWAMI	8967482928
37	XIX	MANI THAKUR	8145916940
38	XIX	USHA MANDAL	8116936177
39	XX	GOLABI KHATUN	7098852348
40	XXI	SHEFALI BIBI	9775844024
41	XXI	JASMINA BIBI	9002620448
42	XXI	GOURI BALA	7602632263
43	XXII	GITA DAS	7602632263
44	XXII	MALATI BARAI	7318696074

Milki Gram panchayet			
Sl. No.	SASAD NO.	NAME OF THE Community Facilitators	cont. No.
1	I	SOVA GHOSH	8759861447
2	I	ASTOMI GHOSH	7407351662
3	II	MONIKA MANDAL	9851719454
4	II	REKHA MANDAL	9851318598
5	III	ANJUMARA BIBI	9614468069
6	III	RINKI KHATUN (BIBI)	7384930523
7	IV	SAHEMA KHATUN	9614723901
8	IV	SUKU KHATUN	9563426754
9	V	AFSANA KHATUN	7478813382
10	V	SABINA YEASMIN	9647139340
11	VI	RUKSENA	7501230193
12	VI	SALENUR	9647809122
13	VII	JOLI BIBI	9733137053

14	VII	SUKIDA KHATUN	9806181202
15	VIII	ALEMA KHATUN	9563405712
16	VIII	SULTANA PERVIN	8436807092
17	IX	JOLI BIBI	9475554744
18	IX	SADENUR KHATUN	9679209678
19	X	ESMA KHATUN	7031333185
20	X	SONAJ BIBI	8670485055
21	XI	MITHU PODDAR	9126370735
22	XI	MINATI MANDAL	
23	XII	CHHAYA KARMAKAR	8016370171
24	XII	ANITA DUTTA	7384481587
25	XIII	TAPASHI MANDAL	9593663094
26	XIII	ANIMA MANDAL	9593309937
27	XIV	RINKI BIBI	7407787011
28	XIV	PRITI RABIDAS	9563278343
29	XV	SAMENA BIBI	9734128932
30	XV	ASHMA BIBI	7031117415
31	XVI	SAGIRA BIBI	9733090137
32	XVI	SANI YADAB	9775195859
33	XVII	NAMITA KARMAKAR	9734946127
34	XVII	GOURI CHOWDHURY	9832480159
35	XVIII	JHUMA GHOSH	9609138849
36	XVIII	RENUKA KHATUN	

Amrity Gram panchayet			
Sl. No.	SASAD NO.	NAME OF THE Community Facilitators	cont. No.
1	I	SITARA BIBI	7031063427
2	I	ANGURI KHATUN(BIBI)	9563452396
3	II	NAJNIN KHATUN	9851955455
4	II	RABINUR BIBI	9614286215
5	III	RUMALI KHATUN(BIBI)	7470234224
6	III	USMANI BEGUM	7031632640
7	IV/19	FIRDOSHI KHATUN(BIBI)	9933978463
8	IV/19	AJMIRA BIBI	8001075725
9	IV/20	RESHMA KHATUN	9932273232
10	IV/20	ABRUN KHATUN(BIBI)	8348413021
11	V	SUSMITA DAS(MANDAL)	9733136162
12	V	MADUMITA MANDAL	9733436591
13	VI	CHANDANA MANDAL	7074462361
14	VI	PROTIMA MANDAL	9593750444
15	VII	SUNITI MANDAL	9749097454
16	VII	MAYA KARMAKAR	7908262468
17	VIII	CHANDANA MANDAL	7098857787
18	VIII	PINKI MAJUMDAR(GHOSH)	7797851831
19	IX	REKHA KARMAKAR	9734123559
20	IX	RUMA MANDAL(DAS)	8906001767

21	X	BASHAKHI MANDAL	9733232776
22	X	MINOTI ROY GUPTA	9733331671
23	XI	SAPTAMI MANDAL	7407421863
24	XI	MALLIKA MANDAL(DAS)	7098857534
25	XII	SHEFALI MANDAL	8670563585
26	XII	SONALI MANDAL	8640848067

Fulbaria Gram panchayet			
Sl. No.	SASAD NO.	NAME OF THE Community Facilitators	cont. No.
1	I	PRITI DAS	7602390256
2	I	PINKI DUTTA	9735870363
3	II	MORJINA BIBI	9933431734
4	II	ASWARANI BIBI	9593687434
5	III	ARSHI BIBI	9547820538
6	III	LUTFUN BIBI	7602974965
7	IV	SABEDA BIBI	7432402066
8	IV	JAHARA KHATUN	9734195640
9	V	ROJINA BIBI	7363064900
10	V	JAYA GHOSH	
11	VI	RUMPA SAHA	8101240094
12	VI	LAXMI KARMKAR	8759433729
13	VII	ASHIMA SAHA	9563467310
14	VII	LILUFA BIBI	7797889345
15	VIII	JOLI BIBI	7797982037
16	VIII	MADHURI GUPTA	9563620624
17	IX	CHAMPA SARKAR	9609524614
18	IX	RAJNANDINI CHOWDHURY	8906646885

Mahadipur Gram panchayet			
Sl. No.	SASAD NO.	NAME OF THE Community Facilitators	cont. No.
1	I	RUKMONI ROY	8972493913
2	I	BAIJANTI ROY	9932106440
3	II	ARCHANA ROY	8972796109
4	II	LALMONI GHOSH	8670809531
5	III	BEAUTI SARKAR	8170866342
6	III	LAXMI MANDAL(SINGHA)	8116671784
7	IV	SHANKARI PARAMANIK(ROY)	9800534212
8	IV	RITA MANDAL	
9	V	PRIYANKA MANDAL	8967832752
10	V	SUPRIYA GHOSH	7063126130
11	VI	JULI MANDAL	9932706014
12	VI	SONAKA MANDAL	7384176037
13	VII	FARIDA KHATUN BIBI	9547323159
14	VII	MINOTI MANDAL	8016615155
15	VIII	AKLEMA BIBI	9093751099
16	VIII	SAKILA BIBI	9932309489

17	IX	POLI SARKAR	7384825304
18	IX	BANCHTA SARKAR	9002226328
19	X	SHIKHA DAS	7602504721
20	X	SAINUR KHATUN	8670165064
21	XI	MASTARA BEWA	7478196853
22	XI	PARVIN BIBI	8116263730
23	XII	MOUMITA SARKAR	7602102341
24	XII	CHHABI MANDAL	9800488066
25	XIII	RINKU GHOSH	7318865040
26	XIII	KAKULI ROY	9933686977
27	XIV	ARCHANA MANDAL	8170907930
28	XIV	KABITA GHOSH	8967748867

Kotwali Gram panchayet			
Sl. No.	SASAD NO.	NAME OF THE Community Facilitators	cont. No.
1	I	LATA MAJHI	8436191439
2	I	BULI MAJHI (SARKAR)	7031508660
3	II	SHRABANTI MANDAL	9733425903
4	II	ANJANA BISWAS	7797494482
5	III	PARVIN BIBI	9593572950
6	III	SUCHETA BISWAS (SINGHA)	9775809511
7	IV	BISHNU PRIYA ROY	9614246433
8	IV	KRISHNA BISWAS (Haldar)	9735090394
9	V	DHRITIKANA ROUTH	8942070914
10	V	KEYA ROUTH	9933706001
11	VI	SUBRATA DAS	9233104459
12	VI	SIMA CHOWDHURY	9564280082
13	VII	MONKHUSI ROY	
14	VII	MINA BISWAS	
15	VIII	NAMITA MANDAL	9933128014
16	VIII	HASNARA BIBI	7407806121
17	IX	LUSI KHATUN	9609840253
18	IX	ASMA KHATUN	9609897299
19	X	SONALI DAS	9593347532
20	X	RUMA DAS	9635539933
21	XI	SUCHARITA DAS	9153186049
22	XI	LILA DAS	9734907911
23	XII	PIYALI GOSWAMI (Mandal)	7063438359
24	XII	ALPONA MANDAL	7384207991
25	XIII	FARHANA RAHAMAN	9851864205
26	XIII	ROJI BIBI	9851974283
27	XIV	TANAJ BANU	9851914490
28	XIV	SIMA CHOWDHURY	
29	XV	MORIYAM BIBI	7548095191
30	XV	SITARA BIBI	9614081297

Binodpur Gram panchayet			
Sl. No.	SASAD NO.	NAME OF THE Community Facilitators	cont. No.
1	I	CHANDANA GOSHWAMI	7872402257
2	I	JHARNA GOSHWAMI	7076952003
3	II	BITHIKA GOSHWAMI	9641439237
4	II	PARUL ROY	9593679002
5	III	CHHAYA SARKAR	8972983466
6	III	RAKHI GOSAWAMI	9091974187
7	IV	JHARNA MANDAL	9002136020
8	IV	SAMPA MANDAL	9593367215
9	V	BABY Mandal	8768121819
10	V	RAKHI CHOWDHURY	8976128369
11	VI	BHANUMOTI MANDAL	7029435462
12	VI	RITA BHATTACHARJEE	9593857355
13	VII	ALPONA MANDAL	9749921665
14	VII	CHINA GOSWAMI	7872186931
15	VIII	JABA RANI MANDAL	9775914061
16	VIII	NAMITA PRAMANIK	9775919466
17	IX	RUPASI MANDAL	7872336262
18	IX	MAMPI MANDAL	9093345593
19	X	SUSUMA MANDAL	9564702140
20	X	SANTI PRAMANIK	7797859383
21	XI	SUKRITY PAUL	7868836101
22	XI	ASIMA MANDAL	9735937332
23	XII	RASEDA KHATUN	7098109663
24	XII	MARJINA KHATUN	7031026049
25	XIII	AMENA BIBI	9614424730
26	XIII	CHHALAN CHOWDHURY	8370956291

Sovanagar Gram panchayet			
Sl. No.	SASAD NO.	NAME OF THE Community Facilitators	cont. No.
1	I	NOOR BANO KHATUN	8759606027
2	I	SULTANA KHATUN	8759509279
3	II	RUNA LAILA	7797924298
4	II	LUSI KHATUN	9563425037
5	III	RESIDA BIBI	8145355325
6	III	RUMA BIBI	7468851201
7	IV	ROKEYA BEWA	9614420861
8	IV	NARGISH BIBI	7278526818
9	V	SMRITI KARMAKAR	9614947402
10	V	PAMPA SARKAR (PODDAR)	7797901197
11	VI	SUNITA SWARNAKAR	9614624880
12	VI	PARBATI KARMAKAR	8906151232
13	VII	CHANDANA LOHAR (KARMAKAR)	9002934125
14	VII	SANTANA KARMAKAR	9563043779
15	VIII	PRITI GHOSH	9563909024

16	VIII	MEMBARI BIBI	9851539672
17	IX	SANCHITA MANDAL (GHOSH)	8670419081
18	IX	SUJITA RAY (GHOSH)	9851265197
19	X	RINA ROY	9547250390
20	X	RANI ROY	7063658743
21	XI	NASERA KHATUN	7407816592
22	XI	SALE BIBI	8436765763
23	XII	RAJIKA KHATUN	7551014655
24	XII	SAHANAJ BIBI	7407785223
25	XIII	ROKIYA BIBI	9735921305
26	XIII	MOSTARI BIBI	7872127433
27	XIV	SABINA ESMIN	8371817187
28	XIV	NURBANU BIBI	8670155624
29	XV	RITA KARMAKAR	9735904964
30	XV	SAIYADA NURBUGAN BIBI	8768308907
31	XVI	MOSLIMA BIBI	9733128583
32	XVI	SUNefa BIBI	7098832024
33	XVII	RINA BIBI	8001717387
34	XVII	MOST MOSLEMA KHATUN (BIBI)	7076913936
35	XVIII	ASMA BIBI	8337836797
36	XVIII	ASMA BIBI	9734376894

Narhatta Gram panchayet			
Sl. No.	SASAD NO.	NAME OF THE Community Facilitators	cont. No.
1	I	SALEHA BIBI	9153843404
2	I	ASNARA BIBI	9800022909
3	II	SEFALI BIBI	8170841307
4	II	HALIMA KHATUN	9733186359
5	III	FARIDA YEASMIN	9891901414
6	III	JARINA BIBI	9153469135
7	IV	MOTEMEBERA PARVIN	9933024357
8	IV	MASTARA BIBI	9679695155
9	V	NASIMA BIBI	8170821585
10	V	SANGITA GOSWAMI	9734092097
11	VI	BABITA MANDAL	7076853935
12	VI	SUMITRA MANDAL	9647056472
13	VII	PUSPA CHOWDHURY	8158932436
14	VII	AKIDAN BIBI	8346806005
15	VIII	SELINA KHATUN	9547138700
16	VIII	RINKI BIBI	9679140358
17	IX	SAKILA KHATUN	7797041816
18	IX	MASEDA BIBI	9134315444
19	X	TUMPA MANDAL	
20	X	SABINA BIBI	7557872072
21	XI	RAJESWARI MANDAL	9734905785
22	XI	CHANCHALA MANDAL	9647219812

23	XII	MITHU MANDAL	9733042490
24	XII	NUR AKTARA BIBI	7407631170
25	XIII	NASIMA BIBI	8967730250
26	XIII	SURMA BIBI	9800402527
27	XIV	CHANCHALA SAHA	8670721160
28	XIV	TRIPTI SAHA	7098688064
29	XV	SAKILA BIBI	9735428909
30	XV	SIPRA SAHA	7076268082
31	XVI	SABINA BIBI	9734957499
32	XVI	DOLI BIBI	8945597230
33	XVII	MADHABI MANDAL	8972571535
34	XVII	ROKEYA NAJРАН	9635969790
35	XVIII	SARIFAN BEWA	7797819062
36	XVIII	SELINA KHATUN	8509884155
37	XIX	KANIKA KARMAKAR	9734120968
38	XIX	RUPALI MANDAL	7031761781
39	XX	HIMANI MANDAL	9232452189
40	XX	RINA MANDAL	8145741299
41	XXI	JAMINA BEWA	7757037463
42	XXI	AYATAN BIBI	9933170865
43	XXII	TAJNUR BIBI	7319034183
44	XXII	MOUSAMI BIBI	9932130396

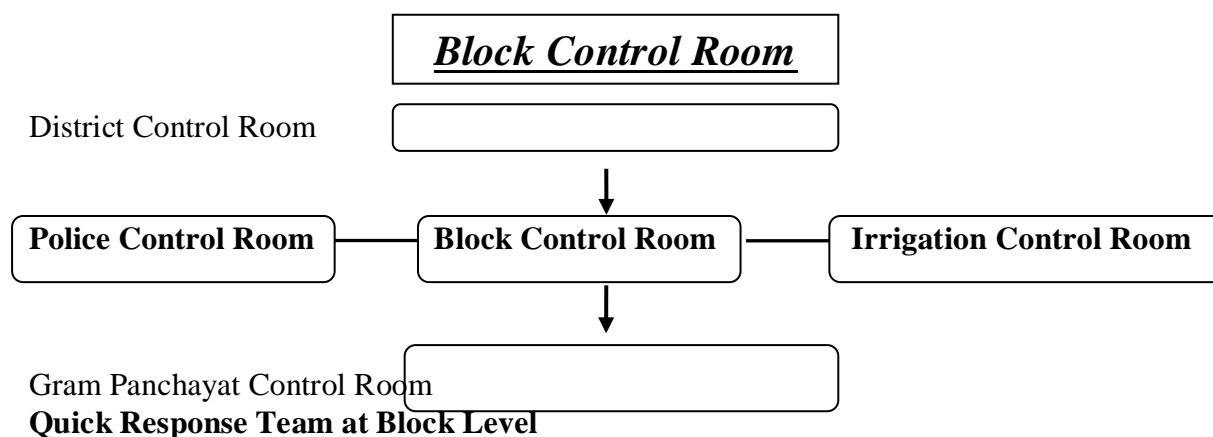

Name of the Officers & Staffs	Designation	Contact No	Duty Allotted
Saugata Chowdhury	B.D.O, EB.	7719360742	Over all In- Charge
Uttam Kr. Biswas	Jt. BDO,EB	8436533210	
SubhashisPoddar	BDMO	7407908299	
Dilip Kr. Ghosh	SAE	9434455906	
Ashok Das	SAE	9434303648	
Mritynjoy Sarkar	T.A	9734906234	
Mainak Banerjee	T.A	9635850549	
Amrita Sarkar	A/C (P.S)	9475094772	
Md. Zamir Hossain	FA	9735025589	
SinghaRajak	BLC	9733008905	
Bankim Mandal	Data Manager (S/W)	9232178964	

DhrubajyotiGoswami	A.H.C	9434820544	Cash Section
Sankar Ch. Basak	A/C (R.D)	9749818381	
Mritunjoy Bhattacharya	Cashier (P.S)	9474473048	
Sudipta Das	Cashier (R.D)	9434684853	
EmdadulHoque	B.I.O	9434314465	Report Section
Sanjoy Kr. Mandal	D.E.O	9474721602	
Suman Sarkar	CA	9933972014	
DoliHansda	G-D	9635751091	
AsimKundu	RC	7501634696	Strong Room
Ashis Kr. Ghosh	PC	9474080803	
JoyetaDatta	SHG & SE Supervisor	9734222286	
Harulal Sarkar	Xerox & GeneratorOpt.	9733419526	

Name of the Officer/Officials engaged at Gram Panchayat Level for Quick Response:

Sl.No.	Name of the G.P	Name of the Officers & Staff	Phone No
1	Sovanagar	KumudRanjan Mandal ,UDC Kousik Kr. Sinha, E.A Avijit Sarkar, N.S Achintya Kr. Das, Secretary Suman Kr. Dey, Sahayak SanjibPramanik. GPK ChanduHazari, GPK	9434394703 9635207929 9734939459 8918905157 9851245768 7098048308 9800903346
2	Milki	MaimurSekh, SEO Bikramjit Banerjee, E.A Narendra Nath Sarkar, N.S Mrinmoy Das, Secretary Koushik Mandal, Sahayak Sufal Chandra Ghosh, GPK Sushila Mardi, GPK Sunil Karmakar, GPK	9800201526 9474017510 9932302975 9609974990 9593877394 9734959502 9932091963 9800354724
3	Fulbaria	ParthaPramanik, PA&AO Ajoy Kr. Sarkar, E.A Bishnupada Barman, NS Nilu Kr. Sinha, Secretary ChayanKantiSaha, Sahayak MdZakir Hossain, GPK Sanup Kumar Singha, GPK	9062716025 9734905143 9733056985 9609907994 9434820095 8653019785 9153035751
4	Kazigram	Niloy Sarkar, Supervisor MSDP Banani Mishra Sanyal,EA BiplabTribedi, NS Suman Kr. Das, Secretary Koushik Mandal, Sahayak Goutam Mandal, Sahayak Subrata Das, GPK Nityananda Das, GPK	9474346485 9475093479 9434206961 9434186121 9609956154 7501021503 9593967265 9735098454
5	Mahadipur	Bimal Kr. Sarkar Anup Kr. Saha, N.S AnirbanSukul, Sahayak	9851023125 8016820014 7551042446

		Shyam Chand Roy, GPK Md. JiaurRahaman, GPK Jhuma Ghosh	9635401934 8906503592 9932715341
6	Jadupur-II	Shiwangi Gupta, FEO Palash Kr. Sinha, EA KousikSaha, NS Siddhartha Singha, Secretary Goutam Sarkar, Sahayak Sanhita Banerjee, Sahayak SwapanBasak, GPK JobayerSk Totan Biswas, GPK	8759498482 9733134873 8918540825 9733303057 9434510835 9474473277 9547034556 9547743411 9733375907
7	Jadupur-I	Mithun Chakraborty, E.A Babli Mandal, N.S Shyamal Kr. Saha, Sahayak Priyanka Jha, Sahayak Buddhadeb Mandal, GPK Prakash Chandra Roy, GPK Samaresh Das	9800142142 9734177606 9614708471 9614608610 8759807310 8900647914 9851897877
8	Amrity	AnupMitra,EA AmalMajumdar,NS Rubi Roy Biswas, Secretary PaltuMisra, Sahayak AninditaJha, Sahayak Manoj Kumar Mandal, GPK PituSk, GPK TanmoyMisra, GPK	9475391361 9614963299 9614407170 7319032211 9734251441 9733218773 9609719995 7602834956
9	Kotwali	RanjanKaithwar, Dy. Secy IshaniPramanik, E.A DipankarKarmakar,NS Kaushik Bhowmik, Secretary Himadri Nandi, Sahayak Jayanta Ghosh, Sahayak Prafulla Kumar Roy,GPK Debabrata Chowdhury, GPK Rajib Chowdhury, GPK	9432379230 9474775799 9800142104 9547494499 9734193216 9832387542 9609769621 9474439867 7501337617
10	Narhatta	Masgul Islam, EA NirmalSamanta, NS SekharGoswami, Secretary Chinmoy Chakraborty, Sahayak Dilip Roy, Sahayak Ala Sk, GPK Pashupati Mandal, GPK Sajib Kr. Das, GPK	9434455964 9434170678 9547384382 8535947266 7584026237 9734555585 9735077306 7797039823
11	Binodpur	BiswajitBalida, EA Subhendu Chowdhury, NS Panchanan Mandal, Secretary Sisir Kumar Dutta,Sahayak TirthaLala DilrubaParvin, GPK Sk. Sariful Islam, GPK Md. Badiruddin, GPK Ananda Goswami, GPK	9732647669 9434681245 8348512938 9093881479 7585976226 9476142444 9733176350 9851884494 9474653172

Arrangement for accommodation of the Victims of Disasters:

As a part of disaster management permanent and temporary Rescue Shelters were identified previously as there is no useable permanent Rescue Shelters available with this Block. All the Educational Institutions are used as Rescue Shelter and the School Authorities are requested for sparing the campuses.

List of Flood Shelter / Rescue Camps (G.P wise)

Sovanagar GP:

(1) Sovanagar H.S, (2) Sovanagar Model Jr. High Madrasah, (3) SovanagarMgd. Pry., (4) Pirpur New C.S Pry., (5) Mohanpur Pry., (6) Malda C.S Pry., (7) Nasirchak Pry., (8) Kauakhand Pry., (9) Uttar Chandipur Pry., (10) Nathinagar Pry., (11) BhabanipurMgd. Pry., (12) SovanagarMgd. Pry., (13) Chandipur J.B. Pry.

Milki GP:

(1) Milki High (H.S) School (2) Bhartitary H.S (3) Milki H/A Branch Pry. (4) Ananda Mohapur Pry. (5) Khaskole Pry. (6) MilkiMgd. Pry. (7) Naraharipur Pry.(8) Shyampur Colony (9) Amgachi Pry. (10) KhaskoleMgd. Pry. (11) Bhagabanpur Pry. (12) Atgama S.P Pry. (13) Milki H/A Pry. (14) Bhartitary Pry. (15) Fatepur Pry.

Amrity G.P

(1) Raigram H.S (2) MohanpurNivedita Girls' H.S (3) Amrity Pry. (4) BaniagramMgd. Pry. (5) Sekendarpur Pry. (6) RaigramMgd. Pry. (7) Manganpara Pry. (8) Gouripur Pry. (9) Madanpur Pry. (10) Vivekananda Vidyapith (11) BaroghariaMgd. Pry. (12) GokulnagarKamat (13) Vinodpur Pry. (14) Battali Pry.

Binodpur G.P

(1) Sattari H.S (2) Uttar Sattari Pry. (3) DakshinChandipur Pry. (4) Basudebpur Pry. (5) Mathurapur Pry. (6) Krishnanagar Pry. (7) Binodpur J.B.Pry. (8) Niamatpur G.S Pry. (9) BaroGosainpur Pry. (10) Gosainpur Kabala Pry. (11) Mobarakpur Pry. (12) GosainpurMgd. Pry. (13) BarampurMgd. Pry. (14) SattariSarbanjanin Pry. (15) Sattari J.B Pry.

Fulbaria G.P

(1) Nagharia High School (2) Nagharia H/A Pry. (3) DarsallaBintola Pry. (4) Balupur S.C Pry. (5) NatunNaghariaMgd. Pry. (6) Fulbaria B.S Pry. (7) FulbariaMgd. Pry. (8) Darsalla Pry.

Narhatta G.P

(1) Budhia High Madrasah (2) Narhatta G.S.H.S (3) BudhiaPaschim Pry. (4) Picchli Pry. (5) Anandipur Pry. (6) Jotegopal Pry. (7) BabupurMgd. Pry. (8) BudhiaMgd. Pry. (9) Laxmipur J.B Pry. (10) Malihat Pry. (11) Laxmipur Pry. (12) Satgharia Pry. (13) Narhatta Pry. (14) Gobindapur Pry. (15) Nagrai Pry. (16) Itakhola Pry. (17) Sailpur Pry.

Jadupur –I G.P

(1) JadupurAnchal H.S (2) Bhagirathi H.S (3) KanchantarMaharajpur Jr. H.S (4) JadupurMgd. Pry. (5) GabgachhiJadupur Pry. (6) SonatolaJadupur J.B (7) KamalabariMgd. Pry. (8) Parbatta C.S Pry. (9) Byspur Pry. (10) Gopinathpur Pry. (11) Narendrapuyr Pry. (12) Maharajpur K. Tar J.B (13) Madhughat J.B.

Jadupur –II G.P

(1) HaziMd Ali Jr. H.S (2) Kamlabari Jr. H.S (3) Kumarpur Pry. (4) KrishnapurMgd.Pry.(5) Amjamtola Pry. (6) Raipur Pry. (7) Moslempur Pry. (8) Gobindapur Pry. (9) Jaharatola Pry. (10) Gopalpur Pry. (11) H.K Konar Colony Pry.

Kazigram G.P

(1) Chandipur B.R.S H.S (2) Kazigram H.S (3) KazigramMgd. Pry. (4) Chandipur J.B (5) Sadanandapur Pry. (6) srirampur Pry. (7) Dilalpur Pry. (8) Uttar Ramchandrapur v (9) Madapur Pry. (10) Sadanandapur Pry. (11) Mahajamapur J.B (12) Manikpur Pry. (13) Damodarpur Pry. (14) Laxmipur Pry. (15) Amrity Colony (16) Rajnagar Pry. (17) JotePrithi Pry. (18) Harishpur Pry. (19) Karmanigram Pry. (20) Bhagalpur Pry. (21) rameswarpur Pry. (22) Kamonagar Pry. (23) Sagardighi Pry. (24) Sadullapur Pry. (25) 52- Bigha Pry.

Kotwali G.P

(1) JoteArapur P.N High (H.S) School (2) JoteArapur T.A Girls' H.S (3) Santa Debya H.S (4) MilikArapur Pry. (5) GouripurMgd. Pry. (6) Maliha Pry. (7) Kotwali J.B (8) KalyanpurMgd. Pry. (9) Nimasarai H.S Pry. (10) JoteNimasaraiMgd. Pry. (11) Daibakipur Pry. (12) JoteRapur P.N.H/A Pry.

Mahadipur G.P

(1) Mahadipur High (H.S) School (2) Mahadipur Girls' H.S (3) Gouripur H.S (4) MahadipurMgd. Pry. (5) Mahadipur S.C Pry. (6) UmarpurR.Ghosh H.S (7) Sagardighi S.C Pry. (8) Khirki Pry. (9) Garmahali Pry. (10) Piyasbari Pry. (11) RamkeliRupsanatan Pry. (12) Kanakpur Pry. (13) Dakhalgram Pry. (14) Khasimari Pry. (15) A.K Gopal Colony Pry.

List of High Land Temporary Flood Shelters:

Sl No.	Name of the G.P	Place where Temporary Flood Shelter will be opened if necessary
1	Milki	Playground of Milki High School
		Playground of Khaskhole high School
2	Sovanagar	Playground of Sovanagar High School
3	Amriti	AmritiShibMandir Ground
4	Binodpur	Playground of Sattari High School
5	Kazigram	Play ground of ChandipurBRS High School
6	Fulbaria	Play ground of Bindpara Pry. School
		Playground of Naugharia High School
7	Narhatta	Play ground of Narhatta G.S High School
		Itakhola Bandh
		Play ground of Lakshmipur Pry. School
8	Kotwali	Play ground of Arapur High School
		Kotwali Market
		Play ground of JoteArapur P.N High School
9	Mahadipur	Play ground of Gouriya High School
10	Jadupur-I	Milan Sangha Playground
11	Jadupur-II	Play ground of Jaharatata High School
		JaharatataMandir Ground

List of Helipad & Air Dropping Sites

Sl.No.	Name & Location of Helipad & Air Dropping Sites	Situated within the area of	Lat& Long
1	Play ground of Sovanagar High School	Sovanagar G.P	25.042267, 87.9766
2	Play ground of Milki High School	Milki G.P	25.03195, 88.0003
3	Play ground of Raigram High School	Amrity G.P	25.0221752, 88.0474484
4	Play ground of Sattari High School	Binodpur G.P	24.9918, 88.03678
5	Play ground of Nagharia High School	Fubaria G.P	25.0413, 88.02758
6	Play ground of BudhiaHigh Madrasah	Narhatta G.P	25.08711, 88.08513
7	Play ground of KamlabariAgnishikha Club & Library	Jadupur-I G.P	25.009347, 88.069979
8	Play ground of ChandipurBRS High School	Kazigram G.P	24.98917, 88.08159
9	Play ground of Kotwali High School	Kotwali G.P	25.0453, 88.11134
10	Play ground of Gouriya High School	Mahadipur G.P	24.8852671,88.13796

List of Trained Civil Defence Volunteers (Collected from SSOI, CD, Malda):

Sl No.	Name	Father's Name and Address	Mobile No.
1	Md. BapiMomin	BarikMomin, Vill& P.O. Amrity	9851798554
2	ManoranjanSaha	UjjalSaha, Vill& P.O. Amrity	9614733615
3	KabirMomin	MatinMomin, Vill& P.O. Amrity	7797989920
4	MrKhushruNadab	OyarehNadab, Vill& P.O. Amrity	9851798117
5	Prakash Mandal	Rabi Mandal, Vill. Basudebpur, P.O. Niyamatpur	7478530816
6	Biswajit Mandal	Buddhadeb Mandal, Vill. Darshalla, P.O. Fulbaria	8293130005
7	AtiulMomin	BarekMomin, Vill. Madia, P.O. Sovanagar	8967948781
8	Manoj Das	Haripada Das, Vill. Pathakpara, P.O. Milki	8759708206
9	Rouf Mia	Md. Chand Mia, Miapara, P.O. Milki	8759501520
10	Tanmoy Chakraborty	Manabendra Chakraborty, 52 Bigha, Bagbari	9547486339

11	RamanandaPramanik	BanamaliPramanik, Sovanagar	9563252213
12	SubrataPoddar	TapanPoddar, Vill. Babupara, P.O. Milki	7031593158
13	Dipankar Choudhury	Gopeswar Choudhury, Vill. Chhotomohanpara, P.O. Amrity	8537931199
14	PrasenjitSaha	ShyamSundarSaha, Vill. Madia	9851716822
15	Sujit Das	Sushil Das, Vill. Chandipur, Kazigram	8972588084
16	Golam Mortuja	Golam Rabbani, Vill. Chandipur, P.O. Sovanagar	9614436405
17	Md. Siman Ali	Md. Tahiruddin, Vill. Chandipur, P.O. Sovanagar	7469011055
18	Sabir Rahaman	MojifulRahaman, Vill. Chandipur, P.O. Sovanagar	8759706597
19	Md. Azaruddin Ahmed	Md. Sahedali, Vill. Chandipur, P.O. Sovanagar	9614986159

List of Boatman:

Sl No	Name of Boatman	Mobile No.
1	SajiruddinSabji	8145845568
2	KajilSabji	7797989537
3	Hiralal Chowdhury	9647702111
4	Mohilal Chowdhury	9932370637
5	Gobinda Chowdhury	7063524731
6	YunusSk	9932999643
7	Abdul Motin	9851386802
8	Harunol Rashid	7031657833
9	FarjanSk	9933365001
10	Dinesh Mandal	9733032834

Contingency Plan of Old Malda Dev Block

Hazard, Vulnerability, Capacity & Risk

Name of the Block	Name of the Vulnerable Gram Panchayats	Name of the Vulnerable Village	Relief Camps and Shelters Tagged
	Mangalbari	Jalanga Naldubi Moulpur Bolatuli	Jalanga Primary School Naldubi Primary School Moulpur Primary School Bolatuli Primary School Block Campus
	Muchia	Bidhangarh Sendia Char Laxmipur Sibgange	Bidhangarh Prathamik Vidyalaya Sendia Prathamik Vidyalaya Char Laxmipur Prathamik Vidyalaya
Old Malda Block	Mahishbathani	Balarampur Balarampur Khanibathan Borkol Sahanagar Islampur Mahishbathani NutonTola Mahishbathani PuratonTola Kadamtali Rahutgaon	Balarampur Managed Pry SWchool Balarampur Nuton Tola Pry School Kadamtoli Pry School Rahutgaon Pry School
	Sahapur	Mahananda Riverside Area Madhaipur Char Kadirpur Choto &Boro Kadirpur Bala Sahapur	Sahapur High School Madhaipur High School Charkadirpur Primary School Choto Kadirpur Primary School Boro Kadirpur Primary School Balasahapur Primary School
	Jatradanga	Meherpur Hatgachi Gabtoli Halna Mohammadpur Jatradanga	Meherpur High School Hatgachi Darial Primary School Baragabtuli Primary School Jatradanga K.B. High Madrasha
	Bhabuk	Not Vulnerable	xxxxxxxxxxxxxxxxxxxxxxxxxxxx

Institutional Arrangement for Disaster Management(DM)

B.D.O. Old Malda Dev. Block will look after the entire relief work and report to the District Relief Section. The subject is purely temporary in nature and subject to change considering the need of the hour that may likely to arise.

LIST OF BLOCK OFFICERS AND STAFFS WITH CONTACT NUMBER(OLD MALDA DEV. BLOCK)

SL NO.	NAME	DESIGNATION	MOBILE NUMBER
1.	Irfan Habib	WBCS(Exe)	7719360741
2.	Ranaditya Biswas	Joint B.D.O.	9735334374
3.	Sushanta Das	S.A.E.(B.P.)	9434456761
4.	Swapan Kumar Saha	S.A.E.(A-1)	9434421816
5.	Priyanka Paul	J.E.(R.W.P.)	9064498090
6.	Sadek Ali	C.I.	9733268058
7.	Debasish Dutta	B.I.O.	9434130055
8.	Koushik Mandal	B.D.M.O.	7384782126
9.	Ashim Kumar Ghosh	F.E.O.	9477469712
10.	Soumita Gupta	W.D.O	9733059006
11.	Subrata Kundu	A.H.C.	9474476689
12.	Sohini Sarkar	Insp. B.C.W.	7044793673
13.	Prodip Kumar Das	Deputy Secretary	9593850797
14.	Koushik Kumar Jha	U.D.,A.P.S.	9434421473
15.	Swati Das	U.D.C(B.P.)	9733110675
16.	Kajal Kumar Dev	A/C(R.D.)	7797903842
17.	Kakoli Saha(Seth)	C.C.	9933412943
18.	Sukumar Tudu	P.C.	9593897675
19.	Parbati Das	L.G.S.	8116338736
20.	Rupsankar Sengupta	F.F.A.	7063399228
21.	Nasrin Banu	Cashier P.S.	9733327742
22.	Sujit Mohanto	Operator	9800215771
23.	Mantu Mahato	D.E.O.	9735010743
24.	Prosanta Lala	A/C(P.S.)	9434981115
25.	Anoy Bagchi	C.C.T.(P.S.)	7797819991
26.	Biswajit Das	L.D.C.	9609704005
27.	Ahindra Nath Das	P.P.	8967286059
28.	Sukumar Sarkar	D.L.T.	8001980029
29.	Jitendra Nath Pramanik	P.S.P.	8967930055
30.	Md. Mahidur Rahman	B.C	6294221758
31.	Pradip Das(Chimru)	Contingent Menial	9933831634
32.	Meshar Ali	Contingent Menial	9932891526

BLOCK CONTROL ROOM

SL NO.	NAME	DESIGNATION	MOBILE NUMBER
1.	Irfan Habib	WBCS(Exe)	7719360741
2.	Ranaditya Biswas	Joint B.D.O.	9735334374
3.	Koushik Mandal	B.D.M.O.	7384782126
4.	Ashim Kumar Ghosh	F.E.O.	9477469712
5.	Rupsankar Sengupta	F.F.A.	7063399228
6.	Anoy Bagchi	C.C.T.(P.S.)	7797819991
7.	Biswajit Das	L.D.C.	9609704005
8.	Ahindra Nath Das	P.P.	8967286059
9.	Pradip Das(Chimru)	Contingent Menial	9933831634
10.	Meshar Ali	Contingent Menial	9932891526

Identify of Shelter ame of the District	Name of Block	Name of Police Station	Name of Gram Panchayat	Name of Village	Name of temporary rescue shelters	Location of the Shelters	Maximum accommodation capacity of the temporary shelters	Name of the Para/lane from where people will come here	Shortest route to be used by the concerned villagers
Malda	Old Malda	Malda	Muchia	Adampur	Madhabpur P.P. Pry School	Mahadebpur	400	Adampur	2 KM by road
				Ajoynagar				Ajoynagar	1 KM by road
				Anandanagar				Anandanagar	2 KM by road
				Muchia	Chandramohon High School	Muchia	2000	Muchia	0.5 KM by road
				Baroipara				Baroipara	0.5 KM by road
				Khanpu				Khanpu	0.5 KM by road
				Sendia				Sendia	2 KM by road
				Shibganj				Shibganj	2.5 KM by road
				Bidhangarh				Bidhangarh	2 KM by road
				Monoharpur	Muchia G.P.Office	Muchia	1000	Monoharpur	0.5 KM by road
				Laxmipur & Char Laxmipur	Laxmipur Pry. School	Laxmipur	700	Laxmipur & Char Laxmipur	1 KM by road
				Najarpur	Kailashpur Pry School	Kailashpur	600	Najarpur	1 KM by road
				Moregram	Moregram Pry. School	Moregram	500	Moregram	0-1 KM by road
				Sujapur	Ganeshpara Pry. School	Sujapur	350	Sujapur	1.5 KM by road

Name of district	Name of Block	Name of Police Station	Name of Gram Panchayat	Name of Village	Name of temporary rescue shelters	Location of the rescue shelters	Maximum accommodation capacity of the temporary shelter	Name of the Para/lane from where people will come here	Shortest route to be used by the concerned villagers
	2	3	4	5	6	7	8	9	10
Malda	Old Malda	Malda	Mahishbathani	Sahanagar	Sahanagar Borkol Managed Primary School	Sahanagar	300	Sahanagar	1 KM by road
				Islampur				Islampur	1 KM by road
				Mahishbathani Nutan Tola	Mahishbathani NutanTola Pry School	Mahishbathani NutanTola	300	Mahishbathani Nutan Tola	2 KM by road
				Mahishbathani Puraton Tola	Gujarghattola Pry School	Gujarghattola	500	Mahishbathani Puraton Tola	2 KM by road
				Gujarghattola & Baluatola				Gujarghattola	
				Kadamtoli	Kadamtali Pry School	Kadamtali	300	Kadamtali	1 KM by road
				Rahutgaon	Rahutgaonn Pry School	Rahutgaon	300	Rahutgaon	1 KM by road
Malda	Old Malda	Malda	Bhabuk	X	X	NOT VULNERABLE	X	X	X
Malda	Old Malda	Malda	Jatradanga	Meherpur	Meherpur High School	Meherpur	500	Meherpur	0-1.5 KM by road
				Hatgachi	Hatgachi Darial Primary School	Hatgachi	250	Hatgachi	0-1.5 KIM by road
				Gabtoli	Baragabtuli Primary School	Gabtoli	300	Gabtoli	0-2 KM by road
				Halna Md.Pur, Jatradanga	Jatradanga K.B.High Madrasha	Jatradanga	1500	Halna Md.Pur	0.5-2 KM by road
								Jatradanga	0-1.5 KM by road
				Page 142					

Name of District	Name of Block	Name of Police Station	Name of Gram Panchayat	Name of Village	Name of temporary rescue shelter	Location of the shelter	Maximum accommodation capacity of the temporary shelter	Name of the para/lane from where people will come here	Shortest route to be used by the concerned villagers
Malda	Old Malda	Malda		Santipur	Upasakorma Pry. School	Santipur	400	Santipur	2 KM by road
				Sahapur 1 No. & 2 No. B.D.Colony	Sahapur Sishu Niketan & Sahapur 1 No. B.D.Colony Pry School	Sahapur	800	Sahapur	0-2 KM by road
				Pabnapara	Bala Sahapur Nimna Buniadi Pry School	Balasaapur	500	Pabnapara	1 KM by road
			Sahapur GP	Chhatianmore	Sahapur High School	Sahapur	600	Chhatianmore	2 KM by road
				Kadirpur & Char Kadirpur	Kiran Moyee Pry School	Charkadirpur	500	Kadirpur & Char Kadirpur	2 KM by road
				Nityanandapur	Nityanandapur Jr. High School	Nityanandapur	500	Nityanandapur	1 KM by road
				Madhaipur & Pathar Madhaipur	Madhaipur High School	Madhaipur	750	Madhaipur	1 KM by road

OLD MALDA DEV. BLOCK**BOAT OWNERS AND CONTACT NO.**

NAME OF G.P.	NAME OF THE BOAT OWNERS	NUMBER OF BOATS	CONTACT
Jatradanga	Mustakhin Sekh	1	7319032440
	Ali Zinnatul	1	8967090873
	Khursed Sekh	1	7479039256
	Firojuddin	1	7478190293
Mahishbathani	Hassan Ali,S/O-Jalaluddin [Balarampur Village]	1	9002895607
	Abdul Salam [Borkol Budhiya Village]	1	8116385426
	Harun al Rashid [Mahishbathani Ferry]	1	8436404877
Sahapur	Sudev Haldar	1	9635860362
	Ananda Rajbanshi	1	7872953040
Muchia	Bittu Das[Charlaxmipur]	1	8759843952
	Nirmal Das[Charlaxmipur]	1	7478135362
Mangalbari	Ziaruddin,S/O-Jamiruddin	1	9749947711
	Salam,S/O-Jamiruddin	1	9749947711
	Rejaul	2	8927581594

Co-ordination Mechanism for implementation of DDMP

Sl. No.	At Block Level Staffs	Name(Designation)	Telephone(Office)	Mobile
A.	Sabhapati, Panchayat Samity	Mrinalini Mandal(Maity)	9932402893	9932402893
B.	Block Development Officer	Irfan Habib	9434738459	9434738459
C.	Karmadhakshya,Sishu-o-nari Unnayan Janakalyan-o-Tran sthayee Samity of Panchayat Samity	Sobha Rajbanshi	9593843849	9593843849
D.	Block Disaster Management Officer	Koushik Mandal	6294687336	6294687336
E.	West Bengal Police	IC,Old Malda	9733008144	9733008144

GRAM PANCHAYAT LEVEL STAFFS

Sl. No.	Name of G.P.	Name of Prodghan and Upo-Prodhan	Contact
1.	Mangalbari	Suraiya Bibi(Prodhan)	8927629179
		Goutam Das(Upo-Prodhan)	8536979785
2.	Muchia G.P.	Subhalaxmi Gain(Prodhan)	8170011365
		Khokan Sarkar (Upo-prodhan)	9614051720
3.	Mahishbathani G.P.	Rajina Bibi(Prodhan)	9800762818
		Rejaul Hoque(Upo-prodhan)	9679318450
4.	Bhabuk G.P	Lakshiram Hansda(Prodhan)	7384054473
		Probhu Nath Dube(Upo-prodhan)	7699116262
5.	Jatradanga G.P.	Ali Nur Hoque(Prodhan)	8918927917
		Satabdi Sarkar(Upo-prodhan)	9800005474
6.	Sahapur G.P..	Ukil Mandal(Prodhan)	7699277199
		Mandira Mandal(Das)(Upo-prodhan)	9851540974

LIST OF VEHICLES TO BE AVAILABLE AT THE TIME OF ANY EMERGENT NEEDS AND STAFFS OF GP/BLOCK

SL. NO.	TYPE OF VEHICLES	NAME OF DRIVER OF VEHICLE	VEHICLE NO.	CONTACT NO.
1.	Bolero(for Block works)	Sagar Block Driver		7318823017
2.	Taxi(Permanent in Old Malda Block)	Rafikul Islam	WB 65B 3960	8101601177

3.	Taxi, Matador etc. supplier	Kartick Saha(Owner)		9002493604
*****	List of NGO'S	*****	*****	*****
4.	Malda Welfare Samiti(Bullet Club)Pirojpur			253923,251087,265140
5.	Name of Official Staffs(Old Malda Block)	Designation		
(i)	Irfan Habib	B.D.O.		9434738459
(ii)	Ranaditya Biswas	Jt. B.D.O.		9933167265
(iii)	Koushik Mandal	B.D.M.O.		6294687336
*****	Name of G.P.	Prodhan		
(i)	Mangalbari	Suraiya Bibi		8927629179
(ii)	Mahishbathani	Rajina		9800762818
(iii)	Muchia	Subhalaxmi Gain		8170011365
(iv)	Bhabuk	Lakshiram Hansda		7384054473
(v)	Jatradanga	Ali Nur Hoque		8918927917
(vi)	Sahapur	Ukil Mandal		7699277199

DIAGNOSTIC CLINICS

SL. NO.	NAME OF DIAGNOSTIC CLINICS	CONTACT NO.	DIAGNOSTIC FACILITIES AVAILABLE
1.	MAULIK NURSING HOME & DIAGNOSTIC CENTRE	(I)9733123291 (II)9933350531 (III)9679610739	PATHOLOGY,X-RAY,USG,ECG,NURSING HOME TREATMENT FACILITIES
	NAME OF AMBULANCE DRIVER	AMBULANCE NO	CONTACT NO
2.	CHAITANYA SARKAR	WB-65/8863	9734130540
	DRUG SHOPS NAME		CONTACT NO.
3.	M/S-MAULIK MEDICINE(IN HOUSE)CENTRE		(I) 9733123291 (II)9679610739

CONTINGENCY PLAN OF GAZOLE DEVELOPMENT BLOCK

1 Area of the Block : 513.73 Sq km

2 No. of Mouza : 293 Nos.

3 Population as per Census 2011 :

Population	Male	Female	Others	Total
Rural	174978	168974	7	343959
Population	Male	Female	Others	Total
Rural	108663	83843	3	192509

4 Literacy rate as per Census 2011 :

5 No. of G.P. : 15

6 No. of Rescue Centre : Nil

7 Total No. of Sansad : 220

8 No. of H.S. School : 25

9 No. of High School : 8

10 No. of Jr. High School : 42

11 No. of Pry. School : 220

12 No. of High Madrasa : 2

13 No. of College : 1

14 No. of Rural Library : 7

15 No. of Rural Hospital : 2

16 No of Block Pry. Health Centre : 1

17 No of PrimaryHealth Centre : 3

18 No. of Subcentre : 60

19 No. of Telephone Exchange : 6

20 No. of Important Ferry : 1

21 No. of MSK : 7

2 No. of SSK : 61

23 No. of Post Office : 1

24 No. of Bank Branches : 15

25 Name of the Important Rivers: 1) Mahananda and 2) Tangan

1. Name of the Block: **Gazole Development Block.**

2. No. & Name of the vulnerable Gram Panchayat: 10 Nos.

a) Alal

b) Bairgachhi-I

c) Bairgachhi-II

d) Chaknagar

e) Salaidanga

f) Raniganj-I

g) Gazole-II

h) Karkach

i) Raniganj-II

j) Babupur

3. Vulnerable points on Embankment/Sluice.

a) Embankment of Mahananda near Pabnapara

b) Kuriadaha Kalinagar Band in Alalo Karkach G.P.

c) Munir Bandh near Ahora Bus Stand.

d) Masahldighi to Muriakundu Bundh

e) Hatnagar to Ahil via Nasinghdanga.

f) Ahil to narsinghdanga doba concerned with link Bundh.

g) Culvert on N.H.-34 near Adina

h) Culvert on Gazole Alal-Road near Rasikpur.

g) Culvert on N.H.-34 near Adina

j) Embankment from Bamongola Ghat to Buridaha.

k) Embankment from Gobindapur to Bachahar.

l) Embankment from Kanchamitha to Bachahar.

m) Embankment from Kamaldanga to Arajai Jalsa.

4. Name of Vulnerable and very Vulnerable Villages.

Alal (Alal Point)					
Sl. No.	Name of Village	Sl. No.	Name of Village	Sl. No.	Name of Village
1	Shrikrishnapur	2	Itbandha	3	North Rajaramchak
4	South Rajaramchak	5	Mobarakkpur	6	Khopatului
7	Suromani	8	Mahakalbana	9	Binodpur
10	Muriakundu	11	Kadamtali	12	Khod Malancha
13	Ranipur	14	Imamnagar	15	Ber
16	Pabnapara	17	Alal	18	Baishbighi

Alal (Moyna Point)					
Sl. No.	Name of Village	Sl. No.	Name of Village	Sl. No.	Name of Village
1	Raghunathpur	2	Nilnagar	3	Debidaha
4	Kalinagar	5	Gourangapur	6	Ahora
7	Durgapur	8	Lakshinarayanpur	9	Champadighi
10	Kharikadighi	11	Nabagram		

Baigachhi-I					
Sl. No.	Name of Village	Sl. No.	Name of Village	Sl. No.	Name of Village
1	Uttar Alinagar	2	Ramnagar	3	Kailabad
4	Dakshin Alinagar	5	Kutubpur	6	Paschim Binodpur
7	Raikhandighi				

Baigachhi-II					
Sl. No.	Name of Village	Sl. No.	Name of Village	Sl. No.	Name of Village
1	Ramkrishnapally	2	Lakshminarayanpur	3	Dewani
4	Nayapara	5	Hazarhat	6	Diarapara
7	Balutola	8	Kushapara	9	Baigachhi North
10	Baigachhi south	11	Akalpur	12	Akalpur Duba

Chaknagar					
Sl. No.	Name of Village	Sl. No.	Name of Village	Sl. No.	Name of Village
1	Mudafat Habinagar	6	Nengrasimul	11	Krishnapur
2	Piralutala	7	Mathamura	12	Sisha Piralutala
3	Doba Khokhsan	8	Bairdangi	13	Kadubari
4	Purbasundarpur	9	Bilkanchan	14	Gangrampur
5	Jhal Jhaliapara(Doba Part)	10	Jot Bairab Doba		

Salaidanga					
1	Hatnagar Doba	6	Narsinghdanga Doba	11	Mahishal
2	Srirampur	7	Ahil	12	Santinagar
3	Suryanagar	8	Jamdanga	13	Poladanga
4	Nayapara	9	Mohammadpur	14	Garadhul
5	Jorpukur	10	Imamnagar	15	Bardanga

Raniganj-I					
1	Raniganj	2	Kamaldanga		

Gazole-II					
1	Rasikpur	3	Banial	5	Bablabona
2	Matail Doba	4	Mashaldighi		

Karkach					
1	Hossainpur	5	Bachahar	9	Uttar Mahinagar
2	Uttar Maldanga	6	Amaitor	10	Atgram
3	Amsole	7	Updel	11	Dakshin Mandanga
4	Ahora(Gourangapur)	8	Kanchannagar	12	Kanchamitha

Raniganj-II					
1	Buridaha	3	Saluka	5	Purba Bil Ahora
2	Karchadanga	4	Altore	6	Araji Jalsa

Babupur					
1	Baje Habinagar	2	Sanbandha	3	Rajnagar

Population Likely to be affected:-

Alal G.P.				
Sl. No.	Name of Mouza	Jl.No.	Population	
1	MALLIKPUR	1	375	
2	KADAMRALI	3	1021	
3	KHOD MALANCHA	4	1585	
4	ALAL	6	2001	
5	KISMAT SULTANPUR	8	3313	

6	MOBARAKPUR	9	1215
7	RAJARAMCHAK	10	5312
8	MAHAKAL BONA	11	2412
9	MURIYA KUNDU	12	2278
10	KAGASURA	13	403
11	BADE MAYNA	117	6315
12	RAGHUNATHPUR	118	301
		Total:-	26531

KARKACH G.P.

Sl. No.	Name of Mouza	Jl.No.	Population
1	ARAZI MISHRABATI	112	2575
2	DAKSHIN MALDANGA	113	525
3	UPDEL	122	745
4	AMSOLE	123	389
5	ATGAN	124	699
6	UTTAR MALDANGA	125	258
7	UTTAR MAHINAGAR	126	2092
8	BACHAHAR	127	1045
9	HOSENPUR	129	488
10	AMAITOR	145	835
11	ICHAHAR	148	485
		Total:-	10136

Babupur G.P.

Sl. No.	Name of Mouza	Jl.No.	Population
1	SANBANDHA	188	589
2	BAJEHABINAGAR	202	81
3	RAJNAGAR	205	745
		Total:-	1415

Chaknagar G.P.

Sl. No.	Name of Mouza	Jl.No.	Population
1	JAJILAPARA	189	799
2	PURBASUNDARPUR	191	657
3	BAIRADANGI	192	2183
4	DUBAKHOKSAN	193	4471
5	BILKANCHAN	194	1129
6	GANGARAMPUR	195	347
7	MUDAFAT HABINAGAR	196	2034
8	JOTBHAIRAB	199	907
		Total:-	12527

SAL AidANGA G.P.			
Sl. No.	Name of Mouza	Jl.No.	Population
1	EAMAMNAGAR	197	3089
2	BAR DANGA	208	595
3	AHIL	258	1180
4	NARASHINDAGA	259	703
5	POLADANGA	260	2334
6	MAHISHAL	261	1833
7	HATNAGAR	263	1974
		Total:-	11708

Gazole-II G.P.			
Sl. No.	Name of Mouza	Jl.No.	Population
1	RASIKPUR	15	1261
2	MATIL	100	1694
3	SHYAMNAGAR	109	1794
4	BANIAL	110	1075
		Total:-	5824

BAIRGACHHI-II G.P.			
Sl. No.	Name of Mouza	Jl.No.	Population
1	AKALPUR	17	2733
2	SAHAROL	19	4366
3	JIGIN	20	1721
4	ARAZI DEHARUL	21	5939
5	BAIRGACHHI	24	4858
		Total:-	19617

BAIRGACHHI-I G.P.			
Sl. No.	Name of Mouza	Jl.No.	Population
1	RYAKHANDIGHI	23	2857
2	BAIRGACHHI	24	3155
3	KAILABAD	25	3740
4	ALINAGAR	26	4896
5	PASACHIM BINODPUR	27	741
		Total:-	15389

RANIGANJ -II G.P.			
Sl. No.	Name of Mouza	Jl.No.	Population
1	SALUKA	262	1694
2	KARCHA DANGA	266	1450
3	ALTOR	267	983
4	BATI JORA	282	2663

List of Halipad & Air Dropping Sites.		
Sl.No.	Sites	Name of G.P.
1	Footbal Ground of Gazole High School.	Gazole -I
2	Tiakati High School Ground	Bairgachhi -II
3	Footbal Ground of Panchpara.	Gazole -II
4	Footbal Ground of near Uttar Noggram	Karkach
5	Footbal Ground at Altore.	Raniganj -II
6	Footbal Ground at Ahil.	Slaidanga
7	Footbal Ground of Raniganj High School	Raniganj -I

Irrigation facilities & Sources:							
Name of Block	Pond	Dugwells	Lipoints	Shallow	River	Khanri	Kennel
Gazole	250	150	NIL	374	73	22	12

Block Control Room

Sl No	Name of the Officers/Staff	Designation
1	Smt Ushnata Moktan	BDO
2	Sri Sandipan Dey	Jt. BDO
3	Sri Ranjan Das	BCW, O/C- Block Disaster Management
4	Sri Manik Kr. Chatterjee	BWO(in-Charge(APO))
5	Sri Mayukh Barik	SAE(A-I)
6	Sri Mridul Banik	BIO
7	Sri Tarun Kumar Majumdar	UDA
8	Sri Sunil Sarkar	Cashier
9	Sri Amit Kr. Dey	CC
10	Sri Sasthi Kumar Das.	Op to C.I.
11	Md. Sahanwaj Rahaman	Gr. D

**DETAILS OF PERSONNEL TO BE DEPLOYED FOR SUPERVISION
AND MANAGEMENT THE TIME OF DISASTER**

1. Information and Management Team

Sl. No.	Name with Designation	Address	Phone Number
1	Smt Ushnata Moktan,BDO	Block Development Office,Gazole	235330/7719360738
2	Sri Haradhan Dev, O/C	Gazole Police Station	235327/9083270317
3	Sri Sandipan Dey, ,Jt.BDO	Block Development Office,Gazole	9932474629
4	Sri Ranjan Das, B.C.W.	Block Development Office,Gazole	7047323308
5	Azinish Husseain shine, CI	Block Development Office,Gazole	9064120494
6	Sri Tapan Kr. Sardar	APO (MGNREGA)	7679045006
7	Sri Sushanta Krityaniya, JTO B.S.N.L.	Gazole Telephone Exchange	235000/9434001273

2. RESCUE AND EVACUATION TEAM

	Name with Designation	Address	Phone Number
1	Rejina Parvin, Savapati	Gazole Panchayat Samity	9733323538
2	Smt Ushnata Moktan,BDO	Block Development Office,Gazole	235330/7719360738
3	Sri Haradhan Dev, O/C	Gazole Police Station	235327/9083270317
4	Sri Sanat Mandal, Divitional Officer	Malda Fire Station	252054/252101/9434420428
5	Sri Sandipan Dey ,Jt.BDO	Block Development Office,Gazole	9932474629
6	Sri Mayukh Barik, S.A.E.(A-I)	Block Development Office,Gazole	9434543890
s7	Sri Bipradev Roy, SAE(BP)	Block Development Office,Gazole	9733221898
8	Sri Prodip Guha Neogi	Forest Range Office, Gazole	235417/9434189884
9	Sri Ranjan Kr. das, B.C.W.,O/C,Block Disaster Management	Block Development Office,Gazole	7047323308
10	Azinish Husseain shine, CI	Block Development Office,Gazole	9064120494
11	Sri Amit Upadhyay, TA ,MGNREGA	Block Development Office,Gazole	9733063429
12	Sri Prasanta Roy,OCM	Block Development Office,Gazole	9851700194

3. Emergency Health Management

Sl No.	Name	Designation & Officer	Phone Number
1	Dr. Gauranga Biswas	Block Medical Officer of Health, BPHC, Hatimary	9933371662 /230202 /230275
2	Dr. Shyam Sundar Halder	Medical Officer-in-charge, Gazole Rural Hospital	9434378739
3	Dr. Brindaban Roy	General Physician, Gazole Rural Hospital	9434231796
4	SriManik Kr. Chatterjee	Block Welfare Officer (in-Charge (APO))	8759101826 / 7908894572
5	Sri Tapan Kr. Sardar	APO(NREGS)	7679045006
6	Sri Khokon Baidya	Child Dev. Project Officer. Gazole Block	235324/988385673 3
7	Smt. Sampa Choudhury	L.G.S.	9733001566

4. Relief (Food,Feed,Fodder and Civil Supplies) Management Team:

Sl No.	Name	Designation & Officer	Phone Number
1	Basanti Roy Mandal	Karmadakshya,Shishu-Nari-Unnayan Janakalyan-O-Tran Sthayee of Gazole Panchyat Samity	6294025087
2	Sri Sandipan Dey ,Jt.BDO	Block Development Office,Gazole	9932474629
3	Dr.Rabindra Nath Mandal	Blok Live Stock Dev. Officer	9732614756
4	Sri Khokon Baidya	Child Dev. Project Officer. Gazole Block	235324/9883856733
5	Sri Manik Kr. Chatterjee	Blok Welfare Officer(in-charge(APO))	8759101826/7908894572
6	Sri Pradip Guha Neogi	Ranger Officer	235417/9434189884
7	Sri Haradhan Dev, O/C	Gazole Police Station	235327/9083270317
8	Sri Manabendra Kr. Saha	ADO, Gazole	03512-234240 / 9434603897
9	Sri Tarak Debnath	Inspector Food & Supply Dept., Gazole.	9475227747
10	Sri Ranjan Kr Das	BCWGazole Block	7047323308
11	Azinish Husseain shine, CI	Block Development Office,Gazole	9064120494

5. TRANSPORTATION MANAGEMENT TEAM

Sl. No.	Name with Designation	Address	Phone Number
1	Smt Ushnata Muktan,BDO	Block Development Office,Gazole	235330/771936073 8

2	Sri Sandipan Dey ,Jt.BDO	Block Development Office,Gazole	9932474629
3	Sri Ranjan Kr Das	BCWGazole Block	7047323308
4	Sri Haradhan Dev, O/C	Gazole Police Station	235327/908327031 7
5	Azinish Husseain shine, CI	Block Development Office,Gazole	9064120494

6. Infrastructure Management Team

Sl. No.	Name with Designation	Address	Phone Number
1	Sri Subrata Ranjan Biswas	Asstt.Engineer Gazole High Way Division	
2	Sri Mayukh Barik, S.A.E.(A-I)	Block Development Office,Gazole	9434543890
3	Sri Susanta Krityaniya, JTO B.S.N.L.	Gazole Telecom Exchange	9434001273
5	Sri Raktim Gupta	The S.M.,Gazole CCC, WBECDCCL	235341/7449302 707

7. ANIMAL RESCUE MANAGEMENT TEAM

Sl. No.	Name with Designation	Address	Phone Number
1	Sri Sandipan Dey ,Jt.BDO	Block Development Office,Gazole	9932474629
2	Sri Ranjan Kr Das	BCWGazole Block	7047323308
3	Ram kumar Mandal	B.L.RO.Gazole	8617241661
4	Azinish Husseain shine, CI	Block Development Office,Gazole	9064120494
5	Sri Pradip Guha Neogi, FO	Forest Range Office	235417 / 9434189884

8. TRAUMA MANAGEMENT TEAM

Sl. No.	Name with Designation	Address	Phone Number
1	Rejina Parvin, Savapati	Gazole Panchayat Samity	9733323538
2	Smt Ushnata Moktan,BDO	Block Development Office,Gazole	235330/771936 0738
3	Sri Sandipan Dey ,Jt.BDO	Block Development Office,Gazole	9932474629
4	Dr. Gouranga Biswas	Block Medical Officer of Health, BPHC, Hatimary	9046030205 /230202 /230275
5	Dr. Shyam Sundar Halder	Medical Officer-in-charge, Gazole Rural Hospital	9434378739
6	Dr. Brindaban Roy	General Physician, Gazole Rural Hospital	9434231796

9.DAILY REPORT & RETURN

- | | |
|-------------------------------------------------|---------------------------------------|
| 1 Sri Sandipan Dey ,Jt.BDO | 6 Sri Tarun Kumar
Majumdar, U.D.A. |
| 2 Sri Manik kr. chatterjee, B.W.O.(in-
Charg | 7 Sri Krishna Ch. Roy,
C.A. |
| 3 Sri Ranjan Kr. Das, BCW | 8 Sri Prasun
Sarkar.CCSK(P/S) |
| 4 Sri Mridul Banik,BIO | |
| 5 SriBiswajit Choudhury,UDC(PS) | |

10.RELIEF STORES

2. Sri Mridul Banik,BIO
3. Sri Tarun Kumar Majumdar,
U.D.A.
4. Sri Prasanta Roy, OCM
5. Sri Sandip Biswas, A/C(P/S)
6. Sri Sasthi Kr.Das,O.P.to C.I.
7. Md. Sahanwaj Rahaman, Gr. D

11.Crop Damage Report :-

1. Sri Manabendra Kr. Saha ,Assistant Director of
Agriculture,Gazole. Contact No. 03512-234240 /
9434603897

12.Arrangement of Fodder and Treatment of Livestock :-

- 1 Sector Alampur Consisting Gram Panchayats
Baigachhi-I&II,Raniganj-I&II,Gazole -
I&II,Alal,Pandua,Majhra.
In Charge:Concerned V.S.
- 2 Sector Deotala Consisting Gram Panchayats
Deotala, Chaknagar, Karkach, Babupur,Sahajadpur &
Salaidanga
In Charge:Concerned V.S.

13.Arrangement of Drinking water at Relief Camps & Disinfection of Tube-well:

- In Charge: 1 Amit Kr. Karmakar, JE, Contact No.-7001779651
2. Gouri Sankar Saha, Mech, Contact No:-9734083497
 3. Naresh Ch. Paul, Helper
 4. Haren Ch. Das, Helper.
 5. Karuna Kanta Goswami, Helper.

14.Law & Order:

1. The Block Development Officer, Gazole Dev. Block.
2. The Officer- In –Charge, Gazole Police Station.

15.Arrangement for Requisition of Boat for rescue operation and requisition of school as flood shelter:

- | | |
|---------------------------------------------------------------------------------------------------------------------------------------------------------------------------------------------------------------------------------------|-------------------------------------------------------------------------------------------------------------------------------------------------------------------------------------------------|
| <ol style="list-style-type: none"> 1. Anup Kumar
Kundu, Sv. D.O.(Addl.), Gazole Block. 2. Samiran
Choudhury F.E.O., Gazole Block 4. Ranjit Sarkar,
R.C. 5. Basudev Haldar, F.A. | <ol style="list-style-type: none"> 1. Mansur Ali, (Rtd. Emp) 2. Azinish Husseain shine, CI 3. Prasun Sarkar,CCS(P.S) 4. Tarun Kumar Majumdar,
UDA |
|---------------------------------------------------------------------------------------------------------------------------------------------------------------------------------------------------------------------------------------|-------------------------------------------------------------------------------------------------------------------------------------------------------------------------------------------------|

Transport Arrangement of Relief Articles and Arrangement of Vehicle for Mobile Duty:

1. Tapan Kr. Sardar , APO, MGNREGS.
2. Biswajit Choudhury, UDA(PS)
3. Rabindra Nath Karmakar,LDA(Ret.)
4. Sudhir Kr. Chakraborty,
UDPC
5. Mansur Ali, (Rtd. Emp)

Person to be constructed for emergent problem of road communication (Malda Highway Division).

Sri Sadhan Das, SAE(PWD)

16.Sanitation and Health and Disinfection of Well:

1. The Block Medical Officer of Health,BPHC, Hatimary
2. Maa-O-Shishu Kalyan Samity, Sanitary Mart,

Sub- Allotment of Relief Materials:

1. The Savapati, Gazole Panchayat Samity, Malda.
2. The Block Development Officer, Gazole Dev. Block, Malda.
3. The Sahakari- Savapati, Gazole Panchayat Samity, Malda.
4. The Jt. Block Dev. Officer, Gazole Dev. Block, Malda.
5. The Karmadhakshya, Sisu-O- Nari Unnayan Janakalyan-O- Tran Sthayee

Samiti.

Substitute of Head of Office incase of his temporary absence :

1. The Jt. Block Dev. Officer, Gazole Dev. Block, Malda.
2. The Assistant Programme Officer (SGSY), Gazole Dev. Block,Malda.

CONTROL ROOM STAFF

Sl No	Name of the Officers/Staff	Designation
1	Smt Ushnata Moktan	BDO
2	Sri Sandipan Dey	Jt. BDO
3	Sri Ranjan Kr. Das	BCW, O/C- Block Disaster Management
4	Sri Manik Kr. Chatterjee	BWO(in-Charge(APO))
5	Sri Mayukh Barik	SAE(AI)

6	Sri Mridul Banik	BIO
7	Sri Tarun Kumar Majumdar	UDA
8	Sri Sunil Sarkar	Cashier
9	Sri Amit Kr. Dey	CC

**DETAILS OF PERSONNEL TO BE DEPLOYED FOR SUPERVISION
AND MANAGEMENT THE TIME OF DISASTER**

1.Information and Management Team

Sl. No.	Name with Designation	Address	Phone Number
1	Smt Ushnata Moktan,BDO	Block Development Office,Gazole	235330/7719 360738
2	Sri Haradhan Dev, O/C	Gazole Police Station	235327/9083 270317
3	Sri Sandipan Dey, ,Jt.BDO	Block Development Office,Gazole	9932474629
4	Sri Ranjan Kr Das	BCWGazole Block	7047323308
5	Azinish Husseain shine, CI	Block Development Office,Gazole	9064120494
6	Sri Tapan Kr. Sardar	APO(NREGS)	7679045006
7	Sri Sushanta Krityaniya, JTO B.S.N.L.	Gazole Telephone Exchange	235000/9434 001273

**Important Telephone No. of Gram Panchayat and Panchayat Samiti
under Gazole Panchayat Samiti**

Sl No.	Name	Contact No.	
		Office	Mobile
Gazole Panchayat Samiti			
1	Rejina Parvin, Sabhapati Gazole Panchayat Samiti	03512-235345	9733323538/ 8918776520
2	Sri Jayanta Kr. Ghosh Sahakari Sabhapati Gazole Panchayat Samiti		9002128080

ALAL GRAM PANCHAYAT			
Office Phone No -			
Sl. No.	Designation	Name	Mobile No.
1	Prodhan	Smt Lakshmi Halder	9002126171
2	Upa Prodhan	Sri Farukh Hussain	8944971544
3	Executive Asst		
4	Secretary	Sri Utpal Kr Roy	9475994635
5	Nirman Sahayak	Md Bojlur Rahaman	9609987768
6	Job Assistant		
7	Sahayak	Sri Jhantu Sarkar	9434323211
8	Sahayak		
9	GPK	Sri Aminul Hoque	9733434387
10	GPK	Sri Jaydeb Chowdhury	7031363201, 9933711851
11	GPK	Sri Bimal Mandal	7602839523
12	GRS	Sri Prasenjit Singha	9851566148
13	Jeebika Sebak	Smt Nasima Khatun	9932338496
14	VLE	Sri Nandagopal Sarkar	7384260489

KARKACH GRAM PANCHAYAT			
Office Phone No - 233318			
Sl. No.	Name	Designation	Mobile No.
1	Prodhan	Smt Fulmani Hasda	8944945666
2	Upa Prodhan	Sri Bancharam Sarkar	9002513977
3	Executive Asst		
4	Secretary	Sri Gouranga Deb Varma	9153353599
5	Nirman Sahayak	Sri Sourav Roy	9593356240, 9614105945
6	Job Assistant		
7	Sahayak	Sri Biplab Kr Kundu	7908535582
8	Sahayak	Sri Ashok Kr Saha	9547152400
9	GPK	Sri Ganesh Ch Mohanta	8967893854
10	GPK	Sri Bikash Kr Sarkar	9932690687
11	GPK		
12	GRS	Sri Riajul Islam	9933144877
13	Jeebika Sebak	Sri Mobasir Hossain	9775412101
14	VLE	Sri Imteyaz Nowaz	9733231278

Deotala			
Sl. No.	Name	Designation	Mobile No.
1	Prodhan	Smt Sultana Rajiya	7872962236
2	Upa Prodhan	Sri Mangal Murmu	9734926873
3	Executive Asst	Sri Tonmoy Das	9635188133
4	Secretary	Sri Nimai Saha	9475676613
5	Nirman	Sri Sabir Alam	9434105721

	Sahayak		
6	Job Assistant		
7	Sahayak	Sri Lokesh Ch Roy	9733197792
8	Sahayak	Sri Shubhendu Mandal	9735095848
9	GPK	Md Mostakim Hossain Choudhury	9932935415
10	GPK	Sri Najibur Rahaman	8348263902
11	GPK	Sri Biswanath Sarkar	9733464267
12	GRS	Md Imran Alam	9734187772
13	Jeebika Sebak	Sri Tanmoy Mudi	8906791511
14	VLE	Sri Shakti Bhumali	9593363684

Babupur

Sl. No.	Name	Designation	Mobile No.
1	Prodhan	Smt Nargis Parvin	9735013284
2	Upa Prodhan	Smt Kapu Hembram	8167370919
3	Executive Asst	Sri Tushar Kanti Sarkar	9932064495
4	Secretary	Sri Tridibesh Biswas	9933419282
5	Nirman Sahayak	Sri Kunal Sinha	9475182313
6	Job Assistant		
7	Sahayak	Sri Niresh Ch Sarkar	9434981430
8	Sahayak	Sri Asim Biswas	9851440233
9	GPK	Sri Abul Kalam Azad	9474082954
10	GPK	Sri Biswanath Sarkar	9547792404
11	GRS	Sri Julfikar Ali Azad	9775915837
12	Jeebika Sebak	Sri Ashim Majumdar	8768912251
13	VLE	Sri Jayanta Pramanik	8145848650

CHAKNAGAR GRAM PANCHAYAT

Office Phone No - 237244

Sl. No.	Name	Designation	Mobile No.
1	Prodhan	Sri Sadhu Charan Sarkar	9933399373
2	Upa Prodhan	Sri Gopal Balo	9733290627
3	Executive Asst	Sujon Sarkar	
4	Secretary	Sri Gokul Ch Mandal	7602837726
5	Nirman Sahayak		
6	Job Assistant		
7	Sahayak	Sri Ganesh Tudu	8116738585
8	Sahayak	Sri Ratan Mahato	7797939738
9	GPK	Sri Ratan Kr Biswas	9733186124
10	GPK	Sri Profulla Kr Roy	9734195211

11	GPK	Sri Nimu Tudu	9800832841
12	GRS	Sri Prasanta Tarafdar	9733343959
13	Jeebika Sebak	Sri Himalay Roy	9733140763
14	VLE	Sri Prasun Pramanik	8972999720
Salaidanga			

Sl. No.	Name	Designation	Mobile No.
1	Prodhan	Sri Sanjoy Besra	7047955753, 9382828892
2	Upa Prodhan	Smt Sadhana Biswas	7477681686
3	Executive Asst	Sri Pradyut Ch Roy	7550912797
4	Secretary		
5	Nirman Sahayak	Sri Supratik Ghosh	9804352056
6	Job Assistant		
7	Sahayak	Sri Tapan Kirtania	9851923196
8	Sahayak	Sri Tanmoy Mandal	9932293861, 8172013442
9	GPK	Sri Himadri Sarkar	9733355543
10	GPK	Sri Sukumar Sarkar	9735089830
11	GPK	Sri Haran Biswas	9775810407
12	GRS	Sri Jahir Abbas	9002580610
13	Jeebika Sebak	Smt Kanij Zohra Khatun	9734167584
14	VLE	Sri Waliuzzaman Azad	9735980035

Sahajadpur

Sl. No.	Name	Designation	Mobile No.
1	Prodhan	Smt Urmila Roy	7602351895
2	Upa Prodhan	Sri Nurtaj Ali	8768750703
3	Executive Asst	Sri Paresch Pramanik	9474470274
4	Secretary		
5	Nirman Sahayak	Sri Manojit Saha	9563805282
6	Job Assistant		
7	Sahayak	Sri Pulak Sarkar	9475091854
8	Sahayak	Sri Pramatha Ranjan Sarkar	9775177141
9	GPK	Sri Bimal Roy	9800508856
10	GPK	Md Nazrul Hoque	9734106102
11	GPK	Minati Soren	
12	GRS	Sri Jyotirmay Mandal	9002856460
13	Jeebika Sebak	Smt Rupali Khatun	9733449321
14	VLE	Sri Habib Mostofa	9547482641, 8250487295

Gazole-I

Sl. No.	Name	Designation	Mobile No.
1	Prodhan	Smt Bindu Pujhar (Mal)	9932138647

2	Upa Prodhan	Sri Kajal Kumar Kundu	9735176174
3	Executive Asst	Sri Swapan Kr Ganguly	8116773408
4	Secretary	Sri Satyajit Mitra	7797057626
5	Nirman Sahayak	Smt Minakshi Kundu	9733273180
6	Job Assistant		
7	Sahayak	Sri Timir Baran Mandal	9733242883
8	Sahayak	Sri Tanmoy Ghosh	9609908238
9	GPK	Sri Uday Kr Das	8016494059
10	GPK	Sri Sankar Saha	9735046598
11	GPK	Sri Chandan Sarkar	9851542215
12	GRS		
13	Jeebika Sebak		
14	VLE	Sri Anupam Kr Goswami	9800937499

Gazole-II			
Sl. No.	Name	Designation	Mobile No.
1	Prodhan	Smt Jayanti Barman (Sarkar)	9851504995
2	Upa Prodhan	Sri Nirmal Mudi	9647591085
3	Executive Asst		
4	Secretary	Sri Manjoy Murmu	9800674150
5	Nirman Sahayak	Smt Sharmistha Dey	7586070206
6	Job Assistant		
7	Sahayak	Sri Raju Sarkar	9434680971
8	Sahayak	Sri Nitish Mandal	9475091362
9	GPK	Sri Uttam Ghosh	9126407576
10	GPK	Smt Kanika Hasda	8670576836
11	GPK	Sri Nagendranath Mandal	8972558696
12	GRS		
13	Jeebika Sebak	Sri Animesh Nath Sarkar	8436358980
14	VLE	Sri Ranjan Kr Paul	8116321200

Bairgachi-II			
Sl. No.	Name	Designation	Mobile No.
1	Prodhan	Sri Subodh Sarkar	7319013980
2	Upa Prodhan	Smt Debi Tudu	9933716035
3	Executive Asst	Sri Souven Ray	7908646184, 9733226868
4	Secretary	Sri Nilanjan Jha	9046946335
5	Nirman Sahayak	Sri Apurba Barai	8967430640, 9647494140
6	Job Assistant		
7	Sahayak	Sri Nabadip Sarkar	7797850499
8	Sahayak	Sri Tanu Roy	9002870727
9	GPK	Sri Chitta Ranjan Karmakar	9932229415

10	GPK		
11	GPK		
12	GRS	Md Rakibul Hoque	9614474982
13	Jeebika Sebak		
14	VLE	Sri Protul Ch Singha	9800062972
Bairgachhi-I			
Sl. No.	Name	Designation	Mobile No.
1	Prodhan	Sri Bharat Chandra Mandal	9593976239
2	Upa Prodhan	Smt Nasima	9932830607
3	Executive Asst	Sri Sasim Ray	9733125566
4	Secretary	Sri Rajib Dutta	9932408424
5	Nirman Sahayak	Sri Subal Roy	9733434391
6	Job Assistant		
7	Sahayak	Sri Sajal Satiar	9775919599
8	Sahayak	Sri Nimai Ch Das	7076684345, 8906412282
9	GPK	Sri Sadek Khan	9932750178
10	GPK	Sri Nowsad Ali	9933012073
11	GRS	Md Ruhul Ansari	9933504350
12	Jeebika Sebak	Sri Panchanan Mandal	8116935528
13	VLE	Sri Al Mamun Hoque	9593672009
Pandua			
Pandua			
Sl. No.	Name	Designation	Mobile No.
1	Prodhan	Smt Sonia Hembram	9734077323
2	Upa Prodhan	Smt Chumki Roy	9932210348
3	Executive Asst		
4	Secretary	Sri Swapan Kr Pramanik	9002164136
5	Nirman Sahayak	Sri Kanak Kr Nandi	9932018502
6	Job Assistant		
7	Sahayak	Sri Sanatan Sarkar	8926588454
8	Sahayak	Sri Daulat Kamal	9733079627
9	GPK	Sri Sukumar Mandal	9679490168
10	GPK	Smt Paddamuni Turi	9474402832, 7063138103
11	GPK	Sri Manilal Karmakar	7407180595
12	GRS	Sri Syed Mojammel Ali	9851378882
13	Jeebika Sebak	Smt Rita Mandal	9609784849
14	VLE	Sri Rajib Karmakar	9734140456
Majhra			
Sl. No.	Name	Designation	Mobile No.
1	Prodhan	Smt Baha Soren	7872255977
2	Upa Prodhan	Sri Kamal Krishna Dhali	9609963162

3	Executive Asst	Sri Dipak Kr Dey	9434821209, 8348412987
4	Secretary		
5	Nirman Sahayak		
6	Job Assistant		
7	Sahayak	Sri Sekhar Kr Bhakta	9002924216
8	Sahayak	Sri Ashish Mandal	9593843734, 8145800340
9	GPK	Sri Hemanta Kr Barman	9002442117
10	GPK	Sri Jugal Krishna Sharma	9932931986
11	GPK	Sri Kamal Tarafdar	9851158970
12	GRS	Sri Mithun Sarkar	9614219938
13	Jeebika Sebak	Sri Avijit Sarkar	9563390171
14	VLE	Sri Biplab Singha	9563922481

Ranijang -I

Sl. No.	Name	Designation	Mobile No.
1	Prodhan	Sri Sanjit Das	8972112360
2	Upa Prodhan	Smt Basanti Hansda	8974302836
3	Executive Asst	Smt Chinmoyee Das	9775433939
4	Secretary		
5	Nirman Sahayak	Sri Liton Ch Ghosh	8535983600
6	Job Assistant		
7	Sahayak	Sri Akhil Mandal	7407813401
8	Sahayak	Sri Joy Murmu	7384849584
9	GPK	Sri Charu Ch Turi	9547581500
10	GPK	Sri Niren Mandal	9609227920, 8116629996
11	GRS	Sri Sagar Kr Roy	9733531198
12	Jeebika Sebak	Sri Pankaj Majumdar	9775812380
13	VLE	Sri Uttam Sarkar	9933641252

Raniganj -II

Sl. No.	Name	Designation	Mobile No.
1	Prodhan	Smt Pravati Murmu	9932116937
2	Upa Prodhan	Sri Debabrata Roy	9064587249
	Executive Asst	Sri Tarini Kanta Paul	8670388117, 9434816822
3	Secretary	Sri Parimal Kr Kundu	9733161746
4	Nirman Sahayak	Sri Partha Sarathi Dutta	9434112217
5	Job Assistant		
6	Sahayak	Sri Shibendra Mardi	9564534573
7	Sahayak	Sri Prasanta Podder	9614496095, 8967563884

8	GPK	Smt Parvet Hembram	8768968094
9	GPK	Sri Anukul Majumdar	9733054890
10	GPK	Sri Samir Roy	9734032923
11	GRS	Sri Sukesh Ch Mandal	9800038208
12	Jeebika Sebak		
13	VLE	Sri Ganesh Sarkar	9734990795

CONTINGENCY PLAN : MANIKCHAK DEVELOPMENT BLOCK

Stakeholders their responsibilities:

Block Development Officer: Block development Officer is the commandant of the Block Disaster management team. All the work like rescue, relief distribution and rehabilitation are done on the basis of his/her supervision.

Police: Police helps in the rescue operation, maintaining law & order during the disaster period of any area.

Irrigation Department: Irrigation department takes an important role in maintaining and repairing of embankment in emergency basis. The dept. also takes necessary action in the time of erosion.

Block Controller of Food & Supply: Block level controller of food and supply takes a crucial role for hoarding food materials at many dealer points before flood and supply the rice, kerosene etc after the disaster.

Block Medical Officer Of Health: Block medical officer arrange the treatment facility for the injured person during any disaster. He also keeps strict vigilance over any outbreak of epidemic. BMOH also send medical team in flood affected area.

Block Livestock Development Officer: Block Livestock development officer takes an important role for the protection of live stock after any disaster by sheltering the cattle, arrange fodder for the cattle, and vicinage the cattle after the flood like disaster.

Assistant Director of Agriculture: Assistant director of Agriculture Measure the area and the quantity of crop which have been damaged by the disaster and also helps the farmers by giving assistance which are provided by the Government.

Dept. of PHE: During any disaster mostly in flood they elevate or setup new tubewell in the flood affected area and also supply water pouch pack for the distribution among the flood affected area.

Electricity Department: The electricity department play an important role in maintenance and supply the power in any area after any disaster.

Sub- Inspector of School: Sub- Inspector of school has the responsibility in running the school properly after disaster and co-ordinate he authority if any school use as relief camp in any disaster period.

Child Development Project officer: Child development Project Officer has an important role for running the ICDS centre and also provide nutritious food to the children and pregnant mother after any disaster.

Dept. of Fire service: Fire service department plays important role in any disaster caused by fire. They helps in the distinguishing the fire also investigate the cause of fire.

Civil Defence: Civil Defence helps the local administration in the rescue operation, relief distribution during and after the disaster.

Non- Government Organization: Non Government Organization helps the government institutions by working jointly in rescue operation, relief distribution, and also helps in the awareness campaign program among the community.

Hazards, Vulnerability, Capacity& Risk Assessment (HVCRA):

Description of history of flood and incurred losses:

Year	Name of G.P. affected	Name of Village Affected	No. of people Affected	No. of Human life lost
2016	Manikchack	Ramnagar, Jotpatta, Haddatola, Torabalitola, Shibontola Narayanpurchor(Dhormutola, Bechutola)	2100	01
	Hiranandapur	Godai(Samsad1&2),Giridharitola	1500	
	Dakshin Chandipur	Duanir Chor	200	
2017	Gopalpur	Elahitola, Ishwartola, Kalitola, Sahabottola.	2000	01
	Hiranandapur	Suksena, Bhobanitola	320	
	Dakshin Chandipur	Narayanpur Chor (Partly)	200	
2018	Hiranandapur, Manikchak (partly)Dakshin Chandipur(partly), Uttar chandipur(partly)	Godai Chor, Ramanagar,Piyaritola, Pulintola, Sukdevtola,Giridharitola, Nazirudintola,Lakshutola	1300	0
2019	Manikchak, Hiranandapur, Dakshin Chandipur, Gopalpur, Dharampur, Nazirpur(Partly), Nurpur(Partly), Mathurapur(Partly), Uttar Chandipur(Partly), Chowki Mirdadpur(Partly)	Godai Chor,Rajkumartola, Santinagar,Jagannathtola,Giridharitola, Ramnagar, Jotpatta,Durgaramtola, Bamacharantola, Duarnir Chor, Lutihara, Gopaltola, Balutola, Narayanpur Chor, Kamaltipur, Jalalpur, Munnar Bagan, Laxmikole, Utshobtola, Jalalpur,Giritola, Bhimtola,Sahebramtola,Karticktola,Haripur, Uttar Hukumattola, Jitmanpur,Wahedmara, .Dallutola Sabjipara, Shyamalpara, Tiyorpara, Giritola ,Bhabanitola.	43000	01

Population Details of the Manikchak Development Block (Census-2011)

GP Name	Total Population	Male	Female
Hiranandapur	21903	11349	10554
Uttar Chandipur	34264	17580	16684
Mathurapur	29758	15422	14336
Dakshin Chandipur	26418	13840	12578
Manikchack	28261	14632	13629
Enayetpur	23780	12168	11612
Chowki Mirdadpur	27228	14143	13085
Dharampur	13140	6865	6275
Gopalpur	18427	9564	8863
Nazirpur	15945	8287	7658
Nurpur	30411	15713	14698
Total	269535	139563	129972

Vulnerable Points on embankment

1	The existing bundh near Domhat to Kamalpur at several points under Manikchak, Dharampur G.P.
2	The Nanditola cut points bundh from Bakducra to Rajkumar tola under Hiranandapur G.P.
3	The bundh at Kankri badhdha points under Mathurapur G.P. Sankartola to Kalitola
4	The entire Bundh cercuit embankment(ring Bundh) of several points covering all the G.Ps. of Bhutni Diara regions.
5	Laskarpur bundh at severals points.
6	The existing bundh near Kesharpur colony of HiranandaPur G.P
7	The bundh near Muniramtola & Durlavtola of Hiranandapur G.P
8	Embankment of the river Ganges near 6 No. retired bundh of Kamaltipur under Gopalpur G.P
9	Embankment near Laskarpur Village under Manikchak G.P.
10	Existing embankment - 360 mtr. North from Manikchak Ghat

Assessment of area prone to river erosion:

Sl. No.	G.P. Name	Area Name
1	Hiranandapur	kesorpur
2	Hiranandapur	Rajkumartola
3	Hiranandapur	Kalutontola
4	Hiranandapur	Godai Chor
5	Dakshin Chandipur	Narayanpur Chor

6	Mathurapur	Sankartola
7	Gopalpur	Switch gate Area

Control Room and Crisis Management team with contact no:

Sl No.	Name of Sector	Name of Officer / Staff	Designation	Phone No.
1	Manikchak	1. Subir Paul	FEO	9231828109
		2. Keshab Ch Das	DEO	8900647544
		3. All G.P Staff		
2	Mathurapur	1. Anupam Ch. Chakraborty	Dy. Secretary [PS]	9064382896
		2. Pallab Mandal	Panchayet Clerk	9641663262
		3. All G.P Staff		
3	Nazirpur	1. Pradip Kr. Das	PDO	9735718428
		2. Biswajit Das	LDA	8918848857
		3. All G.P Staff		
4	D.Chandipur	1. Supratik Das	BWO	8759602816
		2. Prosenjit Sarkar	UDC(PS)	9733205325
		3. All G.P Staff		
5	Hiranandapur	1.Sumangal Das	Jr. Engineer(BP)	9064360167
		2. Tilak Rajak	AO	8918887819
		3. All G.P Staff		
6	Uttar Chandipur	1.Sougata Mitra	IMW	9749641955
		2. Subhadip Ghosh	Accounts clerk	9474797213
		3. All G.P. Staff		
7	Nurpur	Monotosh Sarkar	<i>AAEO</i>	7384207699
		2. Nurul Islam	Asst. Acct, MDM	9734968071
		3. All G.P Staff		
8	Gopalpur	1.Sukanta Biswas	EOMEE	9474418361
		2.Shyamal Ghosh	O.C.M.	8927498824
		3. All G.P Staff		
9	Chowki Mirdadpur	1. Probodh Kr. Das	SAE (AI)	9932303881

		2. Prasenjit Das	JSE(SWAN)	9153038483
		3. All G.P Staff		
10	Dharampur	1. Dilip Saha	C.I	9434872054
		2. Tapas Basak	Data Manager	9851111123
		3. All G.P Staff		
11	Enayatpur	Probal Bhomik	BPM	9733314297
		2. Md. Rousan Alam	CCT	9734910573
		3. All G.P Staff		
12	Block Control Room	1. Palash Das	BDMO	8013244985
		2. Jayanta Mandal	RC	8101850163
		3. Anup Mukherjee	Cashier PS	9831044641
		4. Prabhat Karmakar	A/C RD	9932303881
		5. Debashish Ghosh	BLF	8653172196
		6. Pipasha Halder	PEON(P.S.)	7031909880
		7. Md Yasin Ali	Driver	8972277882
		8. Pradyut Sarkar	NG TCPC	9851593599
		9. Latika Saha (Dey)	Gr-D, TCPC	9749313265

List of Doctors and Contact no.:

Sl. No.	Name of Doctors	Contact no.
1	Hemnarayan Jha (BMOH)	9748231194/7890391168
2	Dr. Amal Kumar Pal	9434425631
3	Dr. Kishore Boron Thakur	7800262739
4	Dr. Tabrej Rahaman	7797972483
5	Dr. Rajesh Saha	9775454508
6	Dr. Ashish Mishra	9775960465
7	Dr. Rathin Kundu	9834680611

Contingency Plan of Englishbazar Municipality

HISTORICAL BACKUP

English Bazar Municipality of malda district is one of the oldest local bodies in this state. To talk of English bazaar, few words on Malda may not be exaggeration. Malda, best known either as 'Gateway of Door' or 'Land of Mango' is located at 25.00 N 88.15⁰ E. It has an average elevation of 17 metres. Mahananda, the ancient river is the silent bystander of ups & downs of different Empires. It is lying in the East of English bazaar. The weather is usually extremely humid and tropical. English Bazar Municipality came to existence nearly 148 years ago and through the passage of time, the municipality has arrived to its present state.

BASIC INFORMATION

English Bazar municipality Malda is Flanked by Bangladesh and South dinajpur at the East, Santhal paraganas of Jharkhand State in the West, Uttar Dinajpur in the North and Murshidabad in the South. Geographically this district town is situated between the latitude 25⁰22'-8' N. longitude 88⁰20'-19E respectively. National Highway (NH-34) proceeds through this district town and rendered it more important and made it approachable from all the parts of the state and the country as a whole.

The town is administratively divided into 29 Wards. The area is 13.25 Sq.m at present. The population density is 16,308.15 per Sq.m in 2011. As per 2011 Census, English Bazar Municipality had a population of 216,083 and the urban agglomeration had a population of 324,237. The Municipality has a sex ratio of 877 females per 1000 males and 14.9% of the population is under six years old. Effective literacy was 84.69: male literacy was 85.44% and females literacy was 83.86%. Communities that inhabit Malda includes the Bengalis, Gorkha, Marwaris, Biharis, Shershahbadhia and Rajbangsis. Some local forms of Bengali, Maithili, Rajbangsi, hindi and urdu are spoken along with local dialects. Commonly spoken languages include Bengali and Hindi. Regional languagees include Pabnai , Nabagangi, kamtapuri, Shershahabadia, Santali and Khotta. Old Malda has a number of Shikh population who suffered in the 1984 anti Sikh Riots. Density Of population has become one of the major issues in English Bazar Resulting and Estimated rise in population to the tune of about 3 (Three) Lakhs at Present due to insurgence from the eroded areas of Malda.

TOPOGRAPHY

The general topography of the Town is mostly alluvial in nature and ideal for different corps and its climate condition is most conducive for Mango Cultivation. Lands here are ordinarily classified into Tal, Diara and Barind, which are very much suitable for cultivation. Due to erosion of soils by inappeasable nature of the rivers one may find several changes of its courses.

❖ **Vulnerable Wards & Embankment / Sluice**

Name of the Vulnerable Wards: 1) Ward No 1, 2) Ward No 2, 3) Ward No 8, 4) Ward No 9, 5) Ward No 12, 6) Ward No 13, 8) Ward No 20, 9) Ward No 21

Vulnerable Points on Embankments / Sluice:

- 1) Maheshpur Baganpara, Maheshpur Gaduamre Jagadishpur, Maheshpur Santalpara In Ward No 1
- 2) Firm Area, In Ward No 2
- 3) Kamarpara Ghat, Dhopapra, Baluchar Nichipara In Ward 8
- 4) North Baluchar, Old F.C.I Office Para, Northbabuchar Muchipara, Nichipara In Ward No 9
- 5) Hatath Coloney, Arabinda Coloney In Ward No 12
- 6) Babupara, Hatath Coloney, In Ward No 13
- 7) Maheshmati In Ward No 17 & 18
- 8) Vivekananda Pally In Ward No 19
- 9) Khotabari, S.M Pally, In Ward No 20
- 10) Gayeshpur, In Ward No 21
- 11) Mahanandapally In Ward No 22

Quick Response Team at Municipal Level:

SI No.	Ward	Contact Person (Councillors)	Mobile No.
1	Ward No 1	Rajib Champati	9832068467
2	Ward No 2	Sumala Agarwala	9434193416
3	Ward No 3	Paritosh Kumar Chowdhury	9851077727 8637883937

4	Ward No 4	Ashok Saha	9434231570
5	Ward No 5	Sumita Banerjee	9434052265
6	Ward No 6	Shipra Roy	9475814287 7908237412
7	Ward No 7	Subrata Sardar	9434245815
8	Ward No 8	Kakali Chowdhury	9434303266
9	Ward No 9	Sanjoy Kumar Sharma	9735052525
10	Ward No 10	Krishnendu Narayan Chowdhury	9434095102
11	Ward No 11	Rajashree Dey	9932932968 7501712664
12	Ward No 12	Prasenjit Das	9800544661
13	Ward No 13	Amlan Bhaduri	9434355444 7908937150
14	Ward No 14	Shampa Saha (Basak)	9434934880
15	Ward No 15	Nihar Ranjan Ghosh	9933160056 9775026587
16	Ward No 16	Gayatri Ghosh	8617495915 8145706499
17	Ward No 17	Subhamoy Basu	9434213256 8972241122
18	Ward No 18	Asis Kundu	9832010010
19	Ward No 19	Runu Das	9932733752
20	Ward No 20	Dulal Sarkar	9434065422
21	Ward No 21	Chaitali Ghosh (Sarkar)	9434105571
22	Ward No 22	Narendra Nath Tewari	9434130005 9609881431
23	Ward No 23	Barnali Halder (Kundu)	8167261210 8906280303
24	Ward No 24	Sutapa Das (Ghosh)	9434206862
25	Ward No 25	Dulal nanda Chaki	9434198020
26	Ward No 26	Anju Tewari	8918354842

27	Ward No 27	Subhadip Sanyal	9874344125 9734137588
28	Ward No 28	Prasenjit Ghosh	9474679898 7384583889
29	Ward No 29	Sumita Sarkar Das	9800807212

❖ **Englishbazar Municipality Disaster Management Committee**

1	Nihar Ranjan Ghosh	Chairman	9933160056 9775026587
2	Dulal Sarkar	Vice Chairman	9434065422
3	Chandan Guha	Executive Officer	9434639269
4	Tanmoy Deb	Finance Officer	9051139303
5	Ashok Charaborty	S.A.E	9434206650
6	Utpal Das	S.A.E	9434120207
7	Sibaji Sarkar	S.A.E	9434186130
8	Jibanjit Biswas	Supdt-In Charge	9593559002
9	Tapas Kundu	Sanitary Inspector	9933029923
10	Subir Roy	Sanitary Inspector	9933066022
11	Naru Gopal Seth	General Section	9232626519
12	Ashish Das	Vehicle Section	9609749177
13	Goutam Roy	Electrician-In-Charge	9733360370

List of Flood Shelter / Rescue Camps

SI No.	Address	Place where Temporary Flood Shelter will be opened if necessary
1	B.S Road	Playground of A.C Institution
2	Banshbari	Playground of Banshbari K.M Balika Vidyalaya
3	R.K Mission Road	Playground of Barlow Girls High School
4	Sadar Ghat	Playground of C.C Girls High School
5	Saratpally	Playground of D.N Saha Vidyabhaban
6	Ghorapir	Playground of Holy Child English Academy
7	Bibigram	Playground of Jalalia Girls High School
8	Gangabag	Playground of L.M.S.M High School
9	Madhabnagar	Playground of Madhabnagar Badalmoni (H.S)
10	Malanchapally	Playground of Malanchapally Minu Jha (H.S)

11	Burabiritala	Playground of Malda Academy High School
12	B.C.Roy Road	Playground of Malda bibhuti Bhusan (H.S)
13	Women's College Road	Playground of Malda Girls High School
14	Dakhshin Baluchar	Playground of Malda J.M.S High School
15	B.T College Road	Playground of Malda Model Madrasa
16	Mahanandapally	Playground of Malda Railway Girls Junior High School
17	Jhaljhalia	Playground of Malda Railway High School
18	Singatala	Playground of Malda Town School
19	Banshbari	Playground of Malda U.C. B Vidyalaya
20	Rabindra Avenue	Playground of Malda Zilla School
21	Kuldip Misra Colony	Playground of Jhanjha Kumar Vidyapith
22	2 no Govt Colony	Playground of Mokdumpur Girls Jr. High School
23	Sukantapally	Playground of North point English Academy
24	Prantapally	Playground of Prantapally Girls Jr. High School
25	2 no Govt Colony	Playground of Ramkinkar Balika Vidyalaya
26	Krishnapally	Playground of T.A.C Balika Vidyalaya
27	R.K Mission Road	Playground of Vivekananda Vidyamandir
28	Buraburitala	Playground of I.T.I College
29	Rabindra Avenue	Playground of Malda College

List of High Land Temporary Flood Shelters:

SI No.	Ward No	Place where Temporary Flood Shelter will be opened if necessary
1	Ward no 21	Playground of Bablabona Primary School
		Vacant Land near Railway Quarter
2	Ward no 8	Both Side of Band Road
		D.S.A Maidan
4	Ward no 12	Both side of Puratuli Bandh Road
5	Ward no 18	Pallysree Field near N.H 34
6	Ward no 20	Kothbari Market Area
7	Ward no 24	Both Side of Buraburitala Gour Bandh Road
8	Ward no 25	Truck Stand Near Ghorapir
9	Ward no 26	Truck Stand Near kaltapara

Identification of Helipad:**List of Helipad & Air Dropping Sites**

Sl.No.	Name & Location of Helipad & Air Dropping Sites	Address
1	Play ground of U.C.B Vidyalaya High School	Banshbari
2	Pallysree Field near Nabin Cinema hall	Ramkrishnapally
3	D.S.A Maidan	R.K Mission Road
4	Railway Institute	Jhaljhalia
5	Jahaj Field	Jahaj Field
6	Vacant Land OF Mahananda Colony	Mahananda Colony
7	Firm Area	Maheshpur
8	Malanchapally Minu Jha (H.S)	Malanchapally
9	Field of Anik Sangha Club	2 no Govt colony
10	Field of C.C Girls high School	Puratuli
11	Field Of L.M.S.M High School	Near Rupkotha Cinema hall

List of N.G.O:

Sl No.	Name	Mobile No.
1	Bharat Scouts & Guides	283301 (R)
2	Bharat Sevasharm Sangha	260459
3	Biswa Hindu Parishad	250718
4	Gour Banga Akanta Apan Welfare Society	264258
5	Indian Medical Association	252132/254100
6	Indian Red Cross Society	250293
7	Inner Wheel Club	252687
8	Kalitala Club (Family Counseling Centre)	252035
9	Lions Club Of Malda Century	9434094222/9046703059
10	Lions Club Of Malda Greater	9733166431/9434054692
11	Lions Club Of Malda Jagrity	
12	Lions Club Of Malda Rainbow	9733069404
13	Lions Club Of Malda	252392 9434149754
14	Live & Late Live Society	
15	Maheshmati Swastika Welfare Society	9232567711/9434355143
16	Malda Club	253276
17	Malda Dist. Voluntary Blood Doners Asson	9434197977/9851273845
18	Malda Medium Club	253595
19	Malda Muslim Institute	221294 9434112227
20	Malda Nagorik Unnayan Samity	252543

21	Malda Sanmilani Kolkata	
22	Malda Welfare Society	250095 9434219336/9434149772
23	Marwari Yuba Mancha	253340
24	New Century Lions Club	9434042642/9434017506
25	Paschim Banga Bigyan Mancha	9434420928/9434232040
26	Ramkrishna Mission	252479
27	Rotary Club Mango City	9434012600/9434053295
28	Rotary Club Of Malda Central	9933053585/9434021414
29	Rotary Club Of Malda	251544 9434219193
30	Seba Bharati	252489
31	Shelter For Malda	9434153414
32	Sree Satya Sai Seba Samity	253738/256622
33	St. Jones Ambulance	252751
34	Pollution Control Broad	9434206618/9232459960

List of Boatman:

SI No	Name of Boatman	Address
1	Mukunda Sarkar	Sukanta Pally
2	Dhiren Sarkar	Near Nimai Sarai
3	Adhir Sarkar	Near North Point School
4	Ram Sarkar	Sukanta Pally

Contingency Plan of Old Malda Municipality

Hazard Vulnerability, Capacity & Risk Assessment (HVCRA)

Name of the Municipality	Name of the Vulnerable Wards	Name of the Vulnerable village	Relief camps and shelters Tagged
Old Malda Municipality	I,II,III,VI,VII,VIII,IX, XI,XVIII,XIX	Nawabganj, Banshut, Mokatipur Colony, Chalisapara, Ramchandrapur, Haldarpara, Nichu para, Bachamari,Baul Math, Schoolpara, Lebubagan, Mahananda Colony.	1) Balia Nawabganj Kalighat pry school . 2) Balia Nawabganj Municipal pry school. 3) Satya Narayan pry School. 4) Old Malda New pry School. 5) Lolabag New Pry School. 6) Old Malda Kalachand High School. 7) Ahaladmoni Girls High School. 8) Bachamari Mag.pry School. 9) Bachamari G.K. Pry School. 10)Osmania High School. 11)G.K.High School. 12)Parasamundai pry School. 13)Gour College. 14)Gour Chandra Ghosh Girls High School.

Institutional Arrangement for Disaster Management (DM)

The Chairman , Old Malda Municipality will look after the eater relief work and report to the District relief s. The Subject is purely temporary in nature and subject to change considering the need of the hour that may likely to arise.

SL No.	Name of the Member & Officers.	Constituency Ward No.	Disinations	Contact No.
01	Kartick Ghosh	IX	Chairman	9434372047
02	Chandana Haldar	XV	Vice-Chairperson	8010521860
03	Bebidas Chowrasia	I	Councillor	8116009858
04	Nepal Haldar	II	"	97355088483
05	Dipti Chowdhury	III		9382677578
06	Bibha Adhikari	IV		9735934326
07	Baisistha Tribedi	V		9563323571
08	Md.Mafijul Islam	VI		9733171456

09	Gouranga Saha	VII		9434130242
10	Anusua Das	VIII		9564417126
11	Masud Hossain(Dollar)	X		9475569692
12	Shilpi Ghosh	XI		9126403606
13	Shanku Sinha	XII		9614694352
14	Paritosh Ghosh	XIII		9932270768
15	Soumen Sarkar	XIV		9434060737
16	Sibankar Bhattacharjee	XVI		9547098085
17	Sujan Kumar Saha	XVII		9932811417
18	Rupali Sarkar	XVIII		9775955910
19	Nripen Paul	XIX		9434421850
20	Sariful Islam	XX		9434170793
21	Probir Roy	-	Excutive Officer	8902247909
22	Suwendu Das Gupta	-	SAE O.M.M	9547449696
23	Swapan Sarkar	-	C.A.to Chairman	9476375079
24	Arun Roy	-	Head Cleark	9933519553
25	Lashhman Saha	-	LDC	9932444551
26	Gouranga Ghosh	-	Cleark	7797877101

OLD MALDA MUNICIPALITY CONTROL ROOM.

SL NO.	NAME	DESIGNATION	MOBILE NUMBER
1)	Lachhman Saha	LDC/OMM/(CONTAT	9932444551
2)	Gouranga Kr. Ghosh	TUAL)LDC/O.M.M	7797877101
3)	Lakshan kr. Haldar	CLEARK/O.M.M	7384888744
4)	Hirk Chakrabarty		9735007552

BOAT OWNERS AND CONTACT NO.

Ward No.	Name of the Boat Owners	Number of Boats	Contact
2	i) Madan haldar	01	8906233190
2	ii) Jogen haldar	01	7063358569
2	iii) Mridanga Haldar	01	9654741327

Co-ordination Mechanism for implementation of DDMP

Sl No	At Municipal level Staffs	Name(Designation)	Telephone(Office)	Mobile
A.	Old Malda Municipality	Probir Roy (Executive Officer)	03512-260235	8902247909
B.	Do	Swapan Sarkar C.A	Do	9476375079
C.	Do	Subhendu Dasgupta SAE	Do	
D.	Do	Tapash Ch. Sarkar SAE	Do	
E.	Do	Lachhaman Saha LDC/OMM	Do	9932444551

F.	Do	Gouranga Kr. Ghosh LDC/OMM	Do	7797877101
G.	Do	Lakshan Kr. Halidar Clerk	Do	7384888744

CONTACT NUMBER OF RAILWAY SERVICE

Department	Contact No
1) Enquiry	(131) 266000
2) Computer Reservation	266944
3) Station Manager	266198
4) D.R.M	266458
5) A.D.R.N	266888
6) D.C.M	266222
7) G.R.P	266489
8) Rail Hospital	266004
9) Godowan	266171
10)M.D.O.M	266335
11)Contral Room	266132

Contingency Plan of Police, Malda

The following measures are being taken to relief / help the marooned / distressed people and to defuse any public unrest during flood or flood like situation.

Setting up of Control Rooms:

A Police Control Room with adequate strength will function round the clock at police line for co-operation with other agencies and regular collection of flood warning message and communicate the same to ICs & OCs and others for taking immediate action / overcome any eventuality.

Police Team :

A team with the strength of 1-10 with one Vehicle will be kept in readiness in each shift at (1) Mothabari PS, 2) Ratua P.S. and 3) Manikchak P.S. Apart from, all ICs and OCs of PSs have been alerted and instructed to keep close liaison with BDOs, BSF and other agencies to tackle any emergent situation.

Flood Rescue Centre /Camp :

Names of Govt. Flood Shelters (Permanent in nature):-

- 1) Harischandrapur Block-II Office Compound under Harischandrapur PS
- 2) Mahanandatola village, Ratua Block-I under Ratua PS
- 3) Kankribandh under Mathurapur G.P. under Manikchak PS
- 4) Dakshin Chandipur G.P. under Manikchak PS
- 5) Kaliachak Block-III office Compound under Baishnabnagar PS
- 6) Kumbhira under Baishnabnagar PS
- 7) Rajnagar under Mothabari PS

ICs and OCs have been directed to draw up list of flood rescue centre/ camp, distribution centre in consultation with local BDOs for taking measures to avoid any untoward incident and smooth supply of relief materials.

Mode of Journey:

ICs and OCs are instructed to collect the names of owners of country boats, mechanized boats which are available at BDO office and GP office. They will also contact with Truck & Mini truck owners Association for early transportation of relief material to the flood affected people.

Identification of Helipad Ground and Co-ordination with Air Force:

The BDOs in consultation with the ICs & OCs of PSs will draw up a list of probable helipads. While selecting such helipads, condition of road and other relevant issues are required to be kept in consideration after necessary inspection by the Air Force Officials for finalizing such list. The following places may be earmarked for preparation of helipads and Air dropping points.

a) Helipad

Sl.No.	Name of Helipads	Police Station
1	Police Lines Ground, Malda	Englishbazar
2	Malda College Ground,	
3	Malda Air Strip, Malda	
4	Harischandrapur High School Ground	Harischandrapur
5	Bhaluka Irrign. Bungalow Ground	
6	Kharba High School Ground	Chanchal
7	Samsi College Ground	Ratua
8	Ratua Football Ground	
9	Pukuria High School	Pukhuria
10	Manikchak Sikha Niketan	Manikchak
11	Nazirpur Football Ground	
12	Kaliachak High School Ground	Kaliachak
13	PWD Stockyard, Mothabari	Mothabari
14	Baishnabnagar Football Ground	Baishnabnagar
15	Gazole High School Ground	Gazole
16	Raniganj High School Ground	
17	Bamongola High School Ground	Bamongola
18	Pakua High School Ground	
19	BSF Ground at Narayanpur	Malda
20	Girija Sundari High School Ground	Habibpur
21	Habibpur High School Play Ground	

Air Dropping Points :-

Air dropping of food grains and relief materials will be done at the places (School grounds/High lands), which are generally not inundated during flood. ICs & OCs of PSs in consultation of respective BDOs will draw up a list of such places, if situation of Air dropping arises and inform DM/SP Malda for prompt action.

Vulnerable Points:

ICs & OCs of PSs are instructed to prepare a list of vulnerable points. The following places may be treated as vulnerable points /places (depending upon the history of flood).

Sl.No.	Name of the Place	Name of G.P.	Name of Police Station
1	Ward No. 8	Municipality Area	Englishbazar
2	Ward No. 9		
3	Ward No. 13		
4	Ward No. 20		
5	Ward No. 12		
6	Fulbaria GP	Fulbaria GP	
7	Kotwali GP	Kotwali GP	
8	Narhata GP	Narhata GP	
9	Kazigram GP	Kazigram GP	
10	Rahutgram		Malda
11	Kadamtali		
12	Mahishbathani		
13	Nawabganj		
14	Bachamari		
15	Haldarpara		
16	Mangalbari		
17	Rabindrapally		
18	Nichupara		
19	Bridgepara		
20	Rashiladaha		
21	Nityanandapur		
22	Sarbamangala		
23	Santipur		
24	Vatra		
25	Chhoto Kadirpur		
26	Raipur Sakarma		
27	Chaki More to Naldubi		
28	Char Laxmipur		
29	Bidhangarh		
30	Singhia		
31	Chinabazar	Baishnabnagar	
32	Sankartola		
33	Birnagar-I GP		Birnagar-I GP
34	Chowdhury Para		
35	Anupnagar		

36	Anil Mondalpara in Parlalpur Village		
37	Pardeonapur		
38	Sovapur		
39	Chakbahadurpur		
40	Simultala		
41	Hamidpur		
42	Panchanandapur		
43	Bangitola		
44	Rathbari		
45	Uttar Lakshmipur		
46	Tofi		
47	Jaluabadha		
48	Mallickpara	Jaluabadhal GP	
49	Kadamtala		
50	Rajnagar Model		
51	Natungram near Bandh	Kaliachak-I GP	
52	Tetrutola		
53	Dinutola	Birnagar-I GP	
54	Bholamasna		
55	Kupadaha		
56	Garapara		
57	Bashipara		
58	Khokshan		
59	Boxchor		
60	Nandinadaha		
61	Bhulkimari		
62	Khutadaha		
63	Haripal		
64	Parhabinagar		
65	Changna		
66	Rakhalpukur		
67	Kathudanga		
68	Sapmari		
69	Guapara		
70	Badiyapara		
71	Gunaidanga		
72	Radhakantapur		
73	Doklaghat		
74	Thakurnagar		
75	Ramkrishnapur		
76	Sishudanga		
77	Parbotidanga		

78	Tungipara		
79	Dhumbalu		
80	Debinagar		
81	Ramnagar		
82	Rishipur		
83	Shaktigarh		
84	Dubapara		
85	Anantapur		
86	Satrasia		
87	Loanpara		
88	Basunagar		
89	Krishnagar Nichpara		
90	Anantapur Ghoshpara		
91	Bulbuchandi Dubapara		
92	Ramkantapur		
93	Khatiyakana		
94	Englishbazar Mohanpur		
95	Kalaibari Sarkarpara		
96	Kalaibari Haldarpara		
97	Jagganathpur Rajapath		
98	Khuji Banpur		
99	Bhuadanga Buritala		
100	Bhajadanga		
101	Bhuadanga		
102	Saidpur		
103	Jogeswar		
104	Ranahat		
105	Raghunathpur		
106	Nilnagar		
107	Lakshinarayanpur		
108	Champadighi		
109	Kharikadighi		
110	Kalinagar		
111	Debidaha		
112	Gourangapur		
113	Durgapur	Alal GP	Gazole
114	Nabagram		
115	Ahora		
116	Srikrishnapur		
117	Srikrishnapur		
118	North Rajaramchak		
119	Itbandha		
120	Suromoni		

121	Imamnagar		
122	Ber		
123	Pabnapara		
124	Alal		
125	Baishbighi		
126	South Rajaramchak		
127	Muriakundu		
128	Binodpur		
129	Kadamtala		
130	Khod Malancha		
131	Ranipur		
132	Mobarakpur		
133	Khopatuli		
134	Mahakalbana		
135	Kanchanagar		
136	Ahora		
137	Kanchandighi		
138	Gourangapur Pry. School		
139	Dakshin maldanga		
140	Updel		
141	Nijgram		
142	Uttar Maldanga	Karkachak GP	
143	Uttar Mahinagar		
144	Kanchamitha		
145	Amsole		
146	Bachahar		
147	Hossainpur		
148	Amaitor		
149	Akhirapukur		
150	Baje Habinagar		
151	Rajnagar	Babupur GP	
152	Sanbandha		
153	Mudafat Habinagar		
154	Nengrasimul		
155	Krishnagar		
156	Piralutola		
157	Jotbhairab Doba		
158	POurba Sundarpur	Chaknagar GP	
159	Bilkanchan		
160	Gangarampur		
161	Jhaljhaliapara(Doba Para)		
162	Dubakhoksan		
163	Bairdangi		

164	Mathmora		
165	Sisha Piralutola		
166	Kadubari		
167	Narsindanga Doba		
168	Jamdanga		
169	Hatnagar Doba		
170	Poladanga		
171	Mahammadpur		
172	Garadul		
173	Bardanga		
174	Imamnagar	Salaidanga GP	
175	Ahil		
176	Nayapara		
177	Mahishal		
178	Srirampur		
179	Santinagar		
180	Surjyanagar		
181	Mahammadpur		
182	Rasikpur Duba		
183	Baniya		
184	Bablabona	Gazole-II GP	
185	Mashaldighi		
186	Matali Doba		
187	Diarapara		
188	Balutala		
189	Kushapara		
190	Bairgachhi North		
191	Dewani		
192	Nayapara	Bairgachhi-II GP	
193	Hajarat		
194	Ramkrishnapally		
195	Lakshinarayanpur		
196	Akalpur		
197	Bairgachhi South		
198	Uttar Alinagar		
199	Ramnagar		
200	Kailabad		
201	Raikhadighi	Bairgachhi-I GP	
202	Dakshin Alinagar		
203	Kutubpur		
204	Paschim Binodpur		
205	Raniganj	Raniganj-I GP	

206	Kamaldanga		
207	Karchadanga	Raniganj-II GP	
208	Saluka		
209	Altore(Part)		
210	Araji Jalsa		
211	Purbabill Ahora		
212	Buridaha		
213	Nairpur GP		
214	Manikchak GP		Manikcak
215	Gopalpur GP		
216	Uttarchandipur		
217	Dakshin Chandipur		Bhutni
218	Hiranandapur		
219	Sripur-I		Pukuria
220	Sripur-II		
221	Sambalpur		
222	Maharajpur		
223	Pukhuria		
224	Pirganj		
225	Araidanga		
226	Parananpur		
227	Chandmoni-I GP	Entire Chandmoni GP-I	
228	Khochkhamar	(under Chandmoni-II GP)	Ratua
229	Balupur		
230	Salabatpur		
231	Harikol		
232	Bompal		
233	Kushraksha		
234	Gopalpur		
235	Bablabona		
236	Karbona Kanchannagar		
237	Faridpur		
238	Jakirnaagar		
239	Uttar Ratua		
240	Pakurtala		
241	Bhado Battala		
242	Chapra		
243	Mirkamari		
244	Bilaimari		
245	Bijli		
246	Sadlichak GP		Harischandrapur
247	Sultannagar GP		

248	Islampur GP		
249	Malior-I GP		
250	Malior-II GP		
251	Masaldah GP		
252	Harischandrapur GP		
253	Kushida GP		
254	Mayapur		
255	Nunator		
256	Jagannathpur	Mahanandapur GP	
257	Rator Boldiaghat		
258	Mahaldar Jelepara		
259	Mahanandapur		
260	Tarapur		
261	Shaktihar		
262	Dumrahal Ghat		
263	Diaganj		
264	Khidirpur	Kharba GP	
265	Sadanpur		
266	Sripatipur		
267	Bhabanipur		
268	Udayganj		
269	Bheba		
270	Uttar Kaligunj		
271	Ramdepur	Bhagwanpur GP	
272	Rathor		
273	Kaliapara		
274	Jaganathpur		
275	Bhabanipur		
276	Jadupur		
277	Nowdapara		
278	Kanaipur		
279	Chandipur		
280	Balarampur	Chandrapara GP	
281	Chandrapara		
282	Baharabad		
283	Goalpara		
284	Khanpur		
285	Madaihat		
286	Hussainpur		
287	Telaigachhi		
288	Galimpur		
289	Mathurapur	Motiharpur GP	
290	Krishnapur		

Chanchal

291	Solmari	Dhangara GP	
292	Ranghat		
293	Elangi		
294	Bisanpur		
295	Balurghat		
296	Haldibari		
297	Islampur		
298	Malahar	Khempur GP	
299	Chorolmoni		
300	Bhawanipur		
301	Babupara		
302	Bijli		
303	Chandi Meheshpur		
304	Kaliganj		
305	Darla		
306	Kashimpur		
307	Paranpur		
308	Khempur		
309	Ajgala	Jalalpur GP	
310	Damaipur		
311	Durgapur		
312	Kaliganj Purbapara		
313	Hazratpur		
314	Jalalpur		
315	Makursa Nayapar	Malatipur GP	
316	Gangadebi		
317	Sanchiya	Gourhand GP	
318	Aladipur		
319	Sukrabari		
320	Mohanpur		
321	Enayatnagar		
322	Jitarpur		
323	Sonarai		
324	Boulia		
325	Soti Sadarpur		
326	Mahanandapur		
327	Kapasiya		
328	Dumro Malikand		

Hospital/BPHC :

All ICs and OCs of PSs have been directed to have close contact with the Block Medical Officer of Health in their respective jurisdiction for prompt medical treatment of flood affected people.

Hospital and Block Medical Centres with Telephone Number:

Sl.No.	Name of Hospitals	Telephone Number
1	District Hospital	03512- 254611, 03512- 252280,
2	BPHC Ratua-I	03513- 266242
3	BPHC Ratua-II	03513- 262228
4	BPHC Malatipur	03513- 266239
5	BPHC Kaliachak-I	03512- 243785
6	BPHC Kaliachak-II	03512- 276208
7	BPHC Kaliachak-III	03512- 222550
8	BPHC Manikchak	03512- 272329
9	BPHC Habibpur	03511- 252345
10	BPHC Bamongola	03511- 261244
11	BPHC Old Malda	03512- 261002
12	BPHC Harischandrapur-I	03513-255322
13	BPHC Harischandrapur-II	03513-257237
14	BPHC Chanchal-I	03513-253489
15	BPHC Chanchal-II	03513-265239
16	BPHC Englishbazar	03512-274699

Name of ICs and OCs of PSs, CIs & concerned Police officers in Malda with their contact Number.

SI No.	Name of Police Station	Name of IC / OC	Mobile No.	Mob. No. of Duty officer
1	Englishbazar PS	Shri Amalendu Biswas	9083270308	7477784451

2	Kaliachak PS	Shri Ashis Das	9083270309 9836551310	7477784454
3	Baishnabnagar PS	Shri Tridip Pramanik	9083270313 9002722365	7477784455
4	Malda PS	Shri Santi Nath Panja	9083270310 9830131160	7477784448
5	Habibpur PS	Shri Purnendu Mukherjee	9083270311 9775401987	7477784449
6	Chanchal PS	Shri Sukumar Ghosh	9083270314	7477784440
7	Harishchandrapur PS	Shri Sanjay Kumar Das	9083270315	7477784441
8	DIO-I, DIB, Malda	Smt. Atreyi Sen	9083270324	03512-252349
9	CI Gazole	Shri Hiranmoy Hore	9083270306	03512-235338
10	CI Ratua	Shri Sanjay Ghosh	9083270307	03513-266090
12	Mothabari PS	SI Bitul Paul	9083270323 9609957049	03512-248655
13	Manikchak PS	SI Debobrata Chakraborty	9083270316 9733043304	7477784452
14	Ratua PS	SI Kunal Das	9083270319 9932098891	7477784442
15	Gazole PS	SI Haradhan Deb	9083270317 9733131477	7477784447
16	Bhutni PS	SI Simon Serpa	9083270321	7477784453

			9153559706	
17	Pukhuria PS	SI Jhatan Prasad	9083270320 9434063114	7477784443
18	Bamongola PS	SI Avishek Talukdar	9083270318 9051057557	7477784446
19	OC Traffic, Malda	SI Tarun Saha	9083270322 9836478444	7477784450
20	OC-Watch, DIB, Malda	SI Rabindra Nath Sinha	8918268545 7679183660	03512-252349
21	OC PCR, Malda	SI Dipankar Sarkar	8617500386	7477784445

Disaster Management Plan, 2020-21

Health & Family Welfare Samity, Malda District

Floods as a natural disaster have a high potential of precipitating the incidences of mass casualties. There is the risk of drowning and physical trauma along with the threat of diseases associated with contamination of water and the creation of mosquito breeding sites. Direct health effects of a flood may include: drowning; injuries like cuts, sprains, fractures, electric shocks; diarrhoea, vector-and rodent-borne diseases like malaria; skin and eye infections; and psychological stress.

The indirect health consequences of floods are usually due to damage caused to health care infrastructure and loss of essential drugs, damage to water and sanitation infrastructure, damage to crops and disruption of food supplies, destruction of property causing lack of shelter that may lead to increased exposure to disease-vectors.

Malda district is the gateway of North Bengal. The district waves by the rivers of The Ganges, Mahananda, Fulhar, Kalindri, Behula etc. and the banks of the riverside areas are flood-prone. After 1998, there was no history of heavy flood in the district. Flood occurred during 2019 in four (4) blocks (Ratua-I, Manikchak, Kaliachak-III & English Bazar) of Malda District. About 4 lakh peoples affected due to Flood various rivers. Since last 5 years, the following blocks including the health facilities were affected due to heavy rains and water logged as below:

Areas and health facilities affected during flood

Sl. No	Name of the Block	No of GP/Muni. affected	Total Popn.	SC area affected	Villages affected	Affected Popn.
1	Harishchandrapur-I	7	58,643	20	35	40,000
2	Harishchandrapur-II	9	182,490	32	69	110,000
3	Chanchal-I	5	67,000	11	21	20,000
4	Chanchal-II	5	66,983	17	32	40,000
5	Ratua-I	9	152,672	24	68	110,000
6	Ratua-II	5	72,655	23	42	30,000
7	Gazole	8	62,882	19	75	25,000
8	Englishbazar	3	32,411	5	12	10,000
9	Old Malda	6	54,618	15	28	25,000
10	Bamongola	5	32,896	9	12	10,000
11	Habibpur	8	54,613	18	29	10,000

12	Manikchak	6	40,500	3	8	20,000
14	Kaliachak-II	4	24,795	5	7	10,000
15	Kaliachak-III	7	48,748	20	26	37,000
Malda		87	951,906	221	464	497,000

1. A district level extended Rapid Response Team (RRT) represented with the following personnel: Dr. Bijoy Prasad Mukhopadhyay , Chief Medical Officer of Health (CMOH) as Chairman and Dr. Amitabha Mandal, Dy. CMOH-II as member Convenor. The other members are:

Members:

- ❖ Dr. Mrigankamouli Kar, Dy. CMOH-I, Malda.
- ❖ Dr. M. K. Ghosh, Dy. CMOH-III , Malda.
- ❖ Dr. Amit Dan, MSVP, MMCH, Malda
- ❖ Dr. Tapas Ghosh, Dy. Superintendent, MMCH, Malda.
- ❖ Dr. N.C. Das, ACMOH (Sadar),Malda.
- ❖ Dr. Somnath Bhattacharyya, ACMOH (Chanchal),Malda.
- ❖ Sri Pramit Bhagat, Epidemiologist (IDSP), Malda.
- ❖ Md. Kabiul Akhter Ali, VBD Consultant, Malda.
- ❖ Mr. Sagnik Chakroborty, Dist. Entomologist, Malda.
- ❖ Md. Badruddoja, Dist. Entomologist, Malda.
- ❖ Md. Mamun Hoque, Data Manager, IDSP, Malda
- ❖ Sri Pallab Kr. Biswas, HA (M), CMOH Office , PH Wing, Malda
- ❖ Sri Dipankar Chaki , HA (M), Dy. CMOH-II, Malda
- ❖ Sri Debapriya Laha, DEO, NPCB, CMOH Office , PH Wing, Malda
- ❖ Sri Jyotirmoy Dev, JE Tech. Asst., CMOH Office , PH Wing, Malda.
- ❖ Sri Adhir Mandal, Peon, CMOH Office , PH Wing, Malda
- ❖ Sri Samir Kumar Das, Peon, CMOH Office , PH Wing, Malda
- ❖ Smt. Bristi Mahinta, Head Clerk, CMOH Office , PH Wing, Malda
- ❖ Smt. Benojir Anowar, Fluorosis Consultant, Malda
- ❖ Smt. Sudipta Chakrabarty, DEO, NVBDCP, Malda
- ❖ Smt. Kathakali Dey, Lab Technician (Fluorosis), Malda

2. A round the clock Control Room will be in operation as and when required in the Office of the Public Health (PH) Wing, CMOH Office, Malda. (Telephone: 03512-223651)

Activity	Name of Nodal Officer	Mobile No	Alternate responsible officer (in absence of Nodal Officer)	Mobile No
Overall	Dr. Bijay Prasad Mukhopadhyay (CMOH)	9432060053	Dr. Mrigankamouli Kar Dy. CMOH-I	8240271669
Reporting	Dr. Amitabha Mandal, Dy. CMOH-II	94750 93320	Dr. Mrinal Kanti Ghosh, Dy. CMOH-III	94751 25119
Logistics (Drugs)	Dy. CMOH-I	8240271669	Dy. CMOH-III	94751 25119

Logistics (Transport)	DY. CMOH-I	8240271669	Dy. CMOH-II	94750 93320
Inter-sectoral coordination	CMOH	9432060053	DY.CMOH-II	94750 93320
Media Management	CMOH	9432060053	DY.CMOH-II	94750 93320

3. The Block Medical Officer of Health (BMOH) in the block will be In Charge of the block level RRT. BMOH will take members from health and other line departments as members of the team. The contact details of the BMOHs and Block Primary Health Nurse (BPHN)/PHNs in the blocks are given below:

Sl No.	Name of the Block	Name of the BMOHs With Mob. No.	Name of the PHNs / BPHNs	Contact No
1	Bamongola	Dr. Sudip Kundu 7031106353	Lipika Saha	9614418015
2	Chanchal-I	Dr. Subrata Bandopaddhay 94331 21012	Tanushree Swarnakar Sefali Roy	96358 15052 99320 18457
3	Chanchal-II	Dr. Prasenjit Halder 9614253503	Mousumi Sarkar	89440 37767
4	English Bazar	Dr. Hossain Md. Sahnawaj 7548072470	Sabita Bhuti Mitali Mandal	81458 33844 97756 53884
5	Gazole	Dr. Sujan Kr. Adhikary 99333 71662	Manjila Khatun Mousumi Das	89069 11054 97331 66943
6	Habibpur	Dr. Punita Shaw 9734192347	Bakul Mahinta	9474797390
7	Harishchandra pur-I	Dr. Amal Krishna Mandal 98000 44474	Archana Mandal (Koner)	98367 41343
8	Harishchandra pur-II	Dr. Sagar Basak 97752 91255	Mala Das Santana Biswas	9874668687 7719318966
9	Kaliachak-I	Dr. Anjum Parvez Alam 9733060900	Madhumita Mandal Fatema Khatun	9563442465 7001616861

10	Kaliachak-II	Dr. Koushik Mistry 9564214594/9434352618	Tumpa Das	9775495343
11	Kaliachak-III	Dr. Debankur Barman 7001066985	Sanchita Roy Sayera Khatun	9748927922 97331 84961
12	Manikchak	Dr. Hem Narayan Jha 7890391168	Shikha Sarkar Sumitra Barman	9547599111 9832505383
13	Old Malda	Dr. Souvik Das 80134 82971/9564797971	Sabita Mandal Susmita Dhal	8250678868 9874052164
14	Ratua-I	Dr. Masud Rahaman 70013 10956	Kalpana Chakrabarty	95474 80669 7278569559
15	Ratua-II	Dr. Deb Kumar Mandal 8013535099	Sunita Bhakta	9474928499

4. The staffs will follow the SOPs during emergency. It will follow the search, rescue, first aid and treatment guidelines. All injured/affected persons (patients) will be identified and they will be managed according to the available resources. The patients will be classified according to the severity of the case and TRIAGE method will be followed in the sites. The staffs will try to identify the deceased and assist the others in the removal, shifting.
5. All district level officers such as Dy. CMOH-I, II & III, ZLO, DTO, ACMOHs of the sub divisions will supervise the respective blocks.
6. The health department will stored sufficient quantities of drugs, equipments and vaccines for utilize during the calamity. Indent will be placed to the Dy. CMOH-I for necessary action.
7. The BMOHs advised to discuss with the block level administration and the PRI to finalise the alternative place to run the health facilities.
8. The district administration is requested to advice the block administration to keep a close liaison with the health department officials in the block level.

Adverse effects of Flood

Adverse effects of floods on health can be prevented by medical preparedness and prompt response through strong communications. Medical preparedness for floods constitutes the following components:

Generate Awareness

The District Health & Family Welfare Samiti will take proactive steps to create awareness to the type of illnesses and other breath problems that can result in the aftermath of floods, to all the medical teams and the community at large. Hygiene and sanitation practices such as hand washing with soap and use of the toilet for defecation, use of boiled water or adding chlorine to water and safe food cooking by disease-free persons will be promoted.

Trained Medical and Rapid Response Teams (RRT)

The District Health & Family Welfare Samiti will ensure the creation of trained Medical and Rapid Response Teams for First Aid and resuscitation measures for drowning cases. Medical staff knows how to take out water from the respiratory tract and how to carry out cardio-pulmonary resuscitation.

Stock of sufficient medicine and logistics

Medical kits will be prepared for the management of flood casualties. Intravenous (IV) fluid (NS and RL), ventilators, oxygen, dressing materials, tetanus toxoid (TT), antibiotics, vaccines, anti-snake venom (AVS) and anti-diarrhoeal drugs will be the most commonly required medical resources. Sufficient medicine stored at District Reserved Stores (DRS) and blocks.

Patient Evacuation Plan

The District Health & Family Welfare Samiti will make available emergency medical equipment and drugs for resuscitation. Paramedical staff trained for resuscitation, triage and to maintain vital parameters like pulse, blood pressure (BP), respiration and intravenous (IV) drip during evacuation. Ambulances need to be deployed to aid in the evacuation of flood casualties collected at high points and it maintained Standard Operating Procedures (SOPs) for treatment.

Management and control of the adverse consequences of floods require coordinated and effective response systems at all levels- district, block, local and community. Many of the components of response initiatives will remain the same for other types of disasters. These systems need to be developed considering the multi-hazard scenario of the region to optimally utilise available resources.

Liaison will maintain with District administration to take up appropriate actions and co-ordinate with the concerned line departments accordingly. The District Health & Family Welfare Samiti has taken the following activities:

**CONTINGENCY PLAN OF
THE DISTRICT INSPECTOR OF SCHOOLS (PRIMARY EDUCATION), MALDA**

1. Awareness of the students is increasing to keep safe distance from the site of cooking of MDM to avoid any hazards from fire.
2. Students are sensitized regarding the use of alternate exit for sudden disaster.
3. It has been continuing to open the rooms of schools for the distressed people during flood.
4. Students are forbidden to touch the electric wire if it is hanging in the school building and other places.
5. Awareness regarding road safety has been discussed with the students, regarding this matter guideline has also provide to all schools.
6. Occasionally students are participating in "Safe Drive Dage Life Programme.
7. Awareness of students for not to stay under the open the sky during heavy lightening/thunderstorm.
8. Students are advised not to make any journey for picnic/educational tour during foggy night to avoid any accident/disaster.
9. For the safety & security of the students, condition of school building has been reviewing time to time.

Flood Contingent Plan for the Year 2020-21 for Sericulture Sector.

Sericulture is a major occupation in rural areas in Malda district which is mostly confined in Kaliachak-I, Kaliachak-II, Kaliachak-III, Chanchal(I ,II), Harishchandrapur(I,II), Manikchak, English Bazar, Gazole & Part of Ratua Block. Sericulture, mainly Mulberry cultivation being practised on high lands. Sericulture concentrated areas of this district are surrounded by River Ganga, Mahananda, Fulohar, Kalindri etc. Keeping apart the year 2016-17 , Sericulture has not been seriously affected by flood during past few years. However considering the unprecedented situation a preparatory plan has been prepared .

Flood Prone Areas under Sericulture:

Sl. No.	Name of Sericulture Technical Service Centres (TSCs)	Areas covering
1	Kaliachak-I, Sujapur,Jalalpur	Kaliachak ,Domaichak,Baishabnagar sujapur,Jalalpur
2	Kaliachak II	Mothabari
3	English Bazar	Piasbari, Amrity
4	Manikchak	Manikchak
5	Ratua	Samsi
6	Chanchal	Chanchal I, II
7	Harischandrapur	Harischandrapur I,II
8	Gazole	Gazole,Alal etc

Probable effect of Flood:-

Due to flood or water stagnation for a long period due to continuous rain Sericulture mainly affected by:-

- i) Damage to Mulberry Plantation partially or completely which is perennial in nature, if the plantation inundated for more than 8-10 days.
- ii) Complete Crop Loss if affected during rearing period particularly during Bhaduri Crop.
- v) Damaged caused to Rearing house.
- vi) Loss of Rearing implements like, Bamboo Made Rearing Tray(Dalla), Bamboo Made Spinning Tray(Chandrakies), Rearing Stands, Rearing Racks, Rearing Net(Cotton & Nylon made) etc.

Plan of assistance to the flood affected areas:-

In case of Sericulture there is limited scope for preparatory measures before flood or during flood period. After flood i.e., after receding of flood water from the affected areas following measures may be taken :

1. For recovery of damaged mulberry plantation, planting materials required to be supplied which is available in our Govt. Farms. Around 1800 Qntl. of Mulberry cuttings will be available in our Govt. farms which can cover 150 Acres of plantations. Financial assistance may also be provided dovetailing with existing Departmental Schemes.
2. In case of crop loss during Bhaduri crop, special thrust would be imposed towards having a good harvest from next crop i.e., from Agrahayani crop . Farmers remain highly eager for Agrahayani Crop.

Contd. To pg-2

(P/2)

3. Disinfection of affected Rearing Houses/ implements by chlorinated disinfectants under mass disinfection programme of the department at nominal charge by Self help Groups, presently 30 such SHG engaged for the purpose.
4. Required Disease Free layings (DFLs) may be supplied from the Govt. Grainages at subsidized rates.
5. In case of complete damage of Rearing house, assistance for construction of new Rearing house under departmental **ISDSI Scheme (Integrates Scheme for the Development of Silk Industry)** can be provided through respective Panchayet Samity.
6. For procurement of rearing implements 75% assistance will also be provided to affected farmers under departmental **SSDP Scheme (Sustainable Sericulture Development Project)** through recommendation of Panchayet Samity.

Deputy Director of Textiles (Sericulture)
MALDA

District Contingency Plan: 2020-21 of Department of F.P.I. & Horticulture, Malda District

Post Flood/Draught/Hail Storm Measures for Malda District

1. Distribution of Winter Vegetable Hybrid Seed Minikit:
Composition of Minikit:

(a) F1 Vegetables Hybrid Seeds of Tomato Brinjal and Chilli

(b) Quantity: Tomato 10gm Brinjal 10gm Chilli 10gm

Cost per Minikit : Rs.1000/-per kit farmer for 5000 Nos. of farmers i.e.

Total Rs.50,00,000/- (Rupees Fifty lakh)only

2. **Distribution of Fruit plants minikit**: Composition of Minikit:

(a) Planting Materials of Mango, Guava & Lime

(b) Quantity: Mango: 10 nos. Guava: 10 nos. Lime:
10 nos.

Cost per Minikit: Rs.1000/-per kit /farmer for 5,000 Nos of farmers i.e

Total Rs. 50,00,000/- (Rupees fifty lakh) only.

3. **Distribution of plants Nutrients as Minikits for Horticultural crops:**
Composition of Minikit:

(a) Trichoderma viridie, Azotobacter, PSB, N:P:K 19:19:19 & Micro
nutrient

(b) Quantity: Trichoderma: 250 gm Neem oil 10000PPM: 100 ml,
Azotobcto: 500 ml, PSB:500 ml,N:P:K 19:19:193

Kg, Micro nutrient 500 ml,

Cost per Minikit: Rs.1000/-per kit /farmer for 5,000 nos. of farmer i.e

Total Rs.50,00,000/- (Rupees fifty lakh) only.

Therefore for District contingent plan of Disaster management / Crop loss due to natural calamity for the year 2020-21 total fund requirement may be **Rs 1,50,00,000/- (Rupees one crore fifty lakh) only.**

**Office of the Executive Engineer (A-M)
Malda (Agri-Mech) Division
Madhabnagar, Malda**

Disaster Management Plan under Malda-I (A-M) Sub-Division, Madhabnagar, Malda

There are 73 nos. of Govt. owned Major River Lift Irrigation Schemes under Malda-I (A-M) Sub-Division among which 41 nos. are Electric Motor-Pump Set operated and 32 nos. are Diesel Engine-Pump Set operated. During heavy rain, water logging condition occurs at different places under Malda District. In this situation, Diesel Engine operated Pump Sets are supplied from Malda-I (A-M) Sub-Division, Madhabnagar, Malda (Water Resources Investigation and Development Department, Government of West Bengal) to remove water from local roads and surroundings. In earlier days, this process was maintained to manage disaster on behalf of Water Resources Investigation and Development Department, Government of West Bengal. Still now it is maintained by storing extra Diesel Engines and Pump Sets under the Sub-Divisional store of Malda-I (A-M) Sub-Division, Madhabnagar, Malda. Flexible Roll Pipes, Combined Tail Pieces, Hose Clamps, Foot Valves and Wire Ropes etc. are also available at Sub-Divisional store of Malda-I (A-M) Sub-Division, Madhabnagar, Malda which are also necessary at water logging condition. This is the Disaster Management Plan under Malda-I (A-M) Sub-Division, Madhabnagar, Malda. List of materials is mentioned below.

LIST OF MATERIALS (Contact Mob. No.-9433351028)

Sl. No.	Details of Material	Quantity	Remarks
1	Diesel Engine with Pump Set	7 Nos.	
2	Flexible Roll Pipes	10 Roll	
3	Combined Tail Piece	12 Nos.	
4	Hose Clamp	20 Nos.	
5	Foot Valve (Complete Set)	3 Nos.	
6	Wire Rope	3 Roll	

Disaster Management Plan under Malda-II (A-M) Sub-Division, Madhabnagar, Malda

There are 17 nos. of Govt. owned Major River Lift Irrigation Schemes under Malda-II (A-M) Sub-Division among which 6 nos. are Electric Motor-Pump Set operated and 11 nos. are Diesel Engine-Pump Set operated. During heavy rain, water logging condition occurs at different places under Malda District. In this situation, Diesel Engine operated Pump Sets are supplied from Malda-II (A-M) Sub-Division, Madhabnagar, Malda (Water Resources Investigation and Development Department, Government of West Bengal) to remove water from local roads and surroundings. In earlier days, this process was maintained to manage disaster on behalf of Water Resources Investigation and Development Department, Government of West Bengal. Still now it is maintained by storing extra Diesel Engines and Pump Sets under the Sub-Divisional store of Malda-II (A-M) Sub-Division, Madhabnagar, Malda. Flexible Roll Pipes, Combined Tail Pieces, Hose Clamps, Foot Valves and Wire Ropes etc. are also available at Sub-Divisional store of Malda-II (A-M) Sub-Division, Madhabnagar, Malda which are also necessary at water logging condition. This is the Disaster Management Plan under Malda-II (A-M) Sub-Division, Madhabnagar, Malda. List of materials is mentioned below.

LIST OF MATERIALS (Contact Mob. No.-8170070998)

Sl. No.	Details of Material	Quantity	Remarks
1	Diesel Engine with Pump Set	2 Nos.	
2	Flexible Roll Pipes	10 Roll	
3	Combined Tail Piece	10 Nos.	
4	Hose Clamp	30 Nos.	
5	Foot Valve (Complete Set)	2 Nos.	
6	Wire Rope	2 Roll	

CONTINGENCY PLAN OF MAHANANDA EMBANKMENT DIVISION, MALDA

FLOOD PREPAREDNESS

Pre-monsoon and pre flood plan :- First necessary effort has been extended to identify the vulnerable spot on the embankment of bank of river like Fulahar and Mahananda and some of them have already been protected by taking early initiative. All the staff including site staff under their jurisdiction is strictly instructed to close vigil the vulnerable site for quick reporting to all concern during any crisis occurred.

On set of monsoon a centralised district flood cell controlled by Malda Irrigation Division. Irrigating and waterways directorate is opened and functioning round the clock by collection rainfall date from India metrological department and river gauge data from different river. All the gauges in the river and sluices are maintained. The different levels like “EDL”, DL” in respect of protected site or different rivers gauge observation are every day informed over phone to the flood cell. As soon as water level reaches DL and EDL Yellow and Red signals are to be imposed and District administration is informed accordingly for taking necessary measures for their end.

In case of major damage/flooding due sudden high discharge of incessant rainfall it will be reported to all concern without any delay and required restoration/strengthening emergency measures during flood will be taken up with consent form competent authority.

The contact details are given below :-

Sl. No	Name with Designation	Address	Contact No
01	Badiruddin Sheikh Executive Engineer	Mahananda Embankment Division, Green Park, Malda	8617665150
02	Aparna Bhakat, Sub-Divisional Officer	Mahananda Embankment Sub-Division No-I, Bhaluka, Malda	9474635611
03	Biswajit Barman, Sub-Divisional Officer	Mahananda Embankment Sub-Division-II, HCpur, Malda	8016012303
04	Debapriya Chakraborty, Sub-Divisional Officer	Mahananda Embankment, Sub-Division No-III, Greenpark, Malda	7001922598

Materials ready for flood fighting at beginning

1. Nylon Crates - 1036
2. Empty polythene bag -28000
3. Fine sand -792.00 cm

List of work will be taken/ongoing work on the vulnerable places before monsoon 2019-20

Sl. No	Name of Work	Estimated cost (lakh)	Remarks
1	Raising and strengthening of Lykol Embankment from Ch. 0.10 Km to Ch 1.20 Km and Ch. 1.60 Km to Ch 4.00 Km for a length of 3.50 km including improvement of inspection path from cjh.0.10 Km to Ch. 1.20 Km and Ch.1.60 km to Ch. 5.30 km in Block Ratua-II, PS Pukhuria, Dist Malda.	153.26	Ongoing
2	Special repair to the 3-vent Rangapur sluice over Mangaldanra channel in Block Harischandrapur-I and 8-vent Bhogadanra sluice over Mahananda Embankment, 2 vent Chator sluice over Mahananda Embankment, 2 vent bokadanra sluice over Sambalpur Circuit Embankment and 4-vent hume pipe culvert over kashdanra canal near Ch, 8 of sambalpur Circuit Embankment in block Ratua-II, PS-Pukhuria & Harischandrapur, District, Malda	106.98	Ongoing
3	Reconstruction of 3 vented sluice structure at Ch. 1.50 Km of lykol embankment in village-Balurghat, Block ratua-II, PS-Pukuria, District Malda	178.42	Under tender
4	Restoration work on country side slope of left Fulahar Embankment including its ancillary work in between Ch. 21.50 Km to 22.50 Km for a total length of 600.00Mts. and in between Ch. 24.00 Km to Ch. 25.00 km for a length of 100.00 Mtr in Block harischandrapur-II, PS-Harischandrapur, Dist-Malda	178.42	Under tender process
5	Restoration of Left Fulahar Embankment near Ch. 32.00 for a length of 300 Mts at Sujapurm near Ch. 30.60 Km for a length of 400 Mtr at debipr in block Ratua-I PS-Ratua and from Ch. 19.40 Km to Ch. 10.55 Km from Ch. 22.40 Km to 23.00 Km including restoration of 2 Nos, bed just up stream of Gobra Hat ferry Ghat and raising strengthening of damaged bundh near Khopakati Primary School in Block, Harischandrapur-II, PS-Harischandrapur, Dist-Malda	191.45	Under tender process
6	Reclamation of berm for a length of 300 m in connection with the restoration of breached embankment on the left bank of rier fulahar (Phase-I) in Vill-Surjapur, Block Ratua-I, PS-Ratua, Malda	240.55	On going

7	Bank protection work to the left bank of river Fulahar for a length of 200 m in between Ch. 14.945 Km to 15.175 Km including strengthening nose of earthen spur no 4 & length of 50.00 m from Ch 15.850 km to 15.900 Km under mouza, Doulatnagar in Block Harischandrapur-II, PS Harischandrapur, Malda	320.48	Under tender process
8	Bank protection work on the right bank of river mahananda for a length of 150.00 mtr at Ellahabad 450.00 mtr at rajapur and 300.00 mtr at Msaharajpur in Block-Ratua-II, PS-Pukhuria and for a length of 750.00 mtr at Islampur in Block Chanchal-I, PS-Chanchal, Dist Malda	472.19	Under tender process

DISASTER MANAGEMENT PLAN OF
DISTRICT CONTROLLER, FOOD & SUPPLIES, MALDA
(FOR THE YEAR 2020-2021)

Action Plan :-

1. Each Godown used for storage of procured rice shall have a rolling reserve of 100 MT rice.
2. Each Rice Mill will maintain a rolling reserve of 100 MT Rice.
3. Every MR Distributor shall keep a rolling reserve stock of 50 MT of Rice.
4. Every SK Oil Agent shall maintain a rolling reserve of 5 (five) KL of SK Oil.
5. Each SK Oil Dealer shall maintain a rolling reserve of 200 litres of SK Oil.
6. Sufficient stock of PDS commodities shall be kept in the fair Price shops to meet any eventuality.
7. Every fuel refilling station shall maintain a rolling reserve of MS/H5D equivalent to their two week's sales volume.
8. Every LPG dealer shall maintain a rolling reserve of LPG equivalent to their one week's sales volume which will be issued to affected people, if necessary.

Control Room & Contact Person of District Official :

Name of Official	Designation	Contract No
Sri Partha Saha, WBF&SS	District Controller (F&S)	03512-252591 /9830623541
Sri Purbha Bhutia, WBF&SS	Asstt. District Controller (F&S)	7477535183
Sri Tapan Barman	Chief Inspector	9775261030
Sri Joy Chakraborty	Chief Inspector	9830752716
Sri Suoriya Nath	Inspector	9775571482
Sri Rajat Kumar Mondal	Inspector	9735233835

Control Room & Contact person of Sub-Divisional Official

Name of Official	Designation	Contract No
Sri Swapnadip Choudhury	Sub-Divisional Controller, Malda	03512-220442/ 8240614456
Sri Ballab Mahato	Chief Inspector	9733161865

Control Room & Contact person of Sub-Divisional Official

Name of Official	Designation	Contract No	Block
Sri Rintu Biswas	Inspector	9830991824	
Sri Rajib Lochan Singha Roy	Inspector	9733557936	
Sri Tarak Debnath	Inspector	9475227747	
Sri Gobibnda Hira	Inspector	897768896	
Sri Abul Wasim	Inspector	9475304227	
Md Almobaserul SK	Inspector	9800556465	
Sri Ridhiman Chatterjee	Inspector	7001066078	
Sri Swapan Chakraborty	Inspector	9831476887	
Sri Debasish Das	Inspector	9475051403	

CONTINGENCY PLAN WBSEDCL (SOUTH MALDA)

Preface

South Malda Division under Malda Region, WBSEDCL playing important role in power distribution in the entire area of southern part of Malda District. Power supply in the entire area is being done through 14 nos. 33/11 KV Sub-Station namely Englishbazar s/s, Kalindi Power Station, Rabindrabhavan s/s, Narayanpur s/s, Muchia s/s, Habibpur s/s, Mothabari s/s, Sujapur s/s, Kaliachak s/s, Baishnabnagar s/s, Manikchak s/s, Mobarakpur s/s, Balia s/s & Golapganj s/s. The Sub-Stations feed power to a widespread area of Englishbazar Block, Old Malda Block, Habibpur Block, all three blocks of Kaliachak and Manikchak block. The Sub-stations receives power at 33 KV level from the 132/33 KV Ghorapir Sub- Station and Khejuria 132/33 KV Sub-station & Gazole 220/132 KV Sub-Station of WBSETCL. Presently it evacuates around 160 Mega Watt of power at peak hours. It is connected to Khejuria 132 KV sub-station by 4 nos. 33 kV circuits, Ghorapir 132/33 KV sub-station by 10 nos. 33 KV circuit & Gazole GSS by 2 nos 33 kV circuits. Total 85 nos. 11 KV feeder evacuating power from those sub-stations. Keeping in view of the importance of the substation any kind of the Disaster within the premises of 33/11 KV substation as well as outside of sub-stations needs to be dealt with effectively and efficiently to ensure smooth flow of electricity in above mentioned 7 blocks.

Executive Summary

This report is a Disaster Management Plan for different 33/11 KV substations. The report has dealt with the aim and objective of the Disaster Management plan in the first chapter. It has been followed by detailed floor wise and building wise risk analysis and the resources both in-house and outside the premises which are available at our end to meet any type of emergent situation. The report also analyzed the worst case scenario in case of any Disaster, the response of the employees present at that moment and the roles and responsibilities of the stakeholders. Emphasizing the need of conducting mock exercises the present status of the mock drills and the future plans have also been analyzed.

Chapter 1 – Introduction

(A) Introduction

Disaster" means a catastrophe, mishap, calamity or grave occurrence in any area, arising from natural or manmade causes, or by accident or negligence which results in substantial loss of life or human suffering or damage to, and destruction of, property, or damage to, or degradation of, environment, and is of such a nature or magnitude as to be beyond the coping capacity of the community of the affected area. "Disaster management" means a continuous and integrated process of planning,

organizing, coordinating and implementing measures which are necessary or expedient for-

- (i) Prevention of danger or threat of any disaster;
- (ii) Mitigation or reduction of risk of any disaster or its severity or consequences;
- (iii) Capacity-building;
- (iv) Preparedness to deal with any disaster;
- (v) Prompt response to any threatening disaster situation or disaster;
- (vi) Assessing the severity or magnitude of effects of any disaster;
- (vii) Evacuation, rescue and relief;

(B) Aim

Evolving a process to manage various types of perceived natural and man made disasters.

(C) Objective

The objective of the report is to delineate the roles and responsibilities of various stake holders, clarify command, control and co-ordinate structure for managing disaster and to formulate evacuation plan without causing panic.

Chapter 2 -Hazard, Risks & Vulnerability Analysis

The 33/11 KV substation premises can be largely divided into two parts as below: -

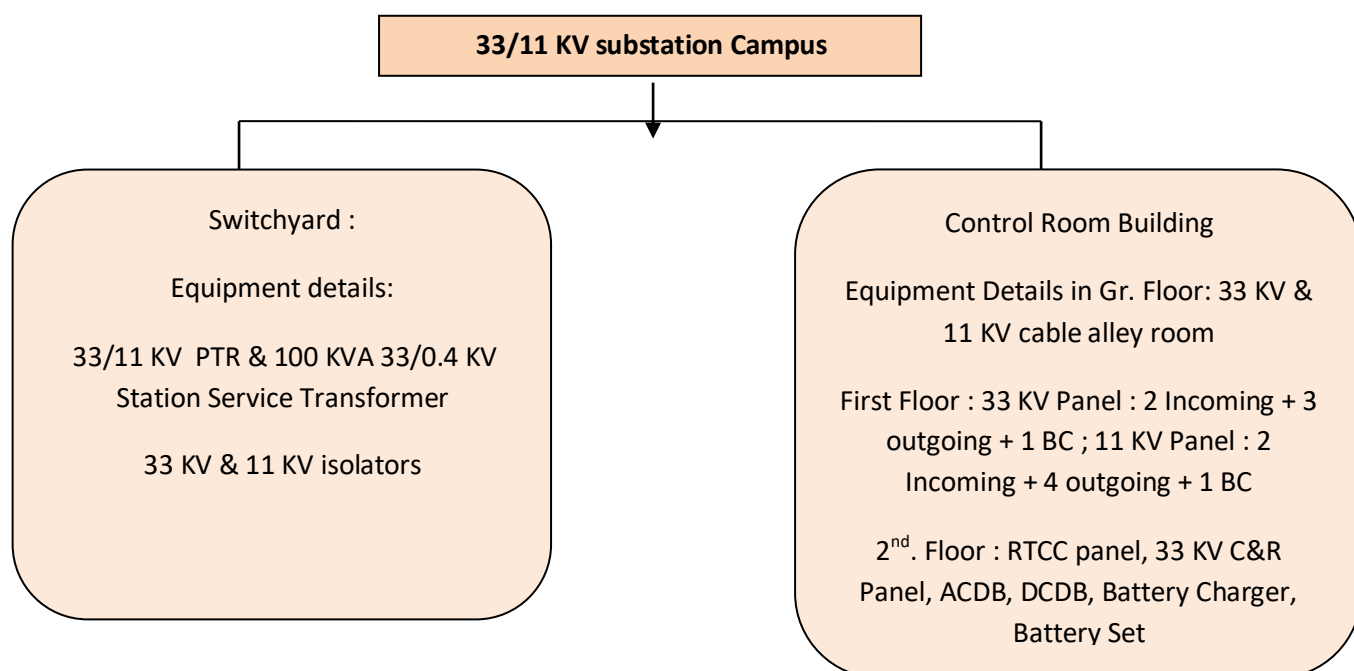

The detailed building wise and floor wise risk analysis and the selected assembly areas are as below: -

Switchyard



SI No	Area	Installations present	Probable Hazards	Assembly Area
1	33kv Switchyard	Equipment details: 33/11 KV PTR & 100 KVA 33/0.4 KV Station Service Transformer 33 KV & 11 KV Isolators; Lightning Arrestors; Insulators	Fire; Earth Quake; Flood; Man Made Disaster	Open area between Switchyard & Main Gate

Control Room Building

1. Ground Floor

SI No	Area	Occupier of room	Materials stored	Probable Hazards	Assembly Area
1	80 sq. Mtr.	Cable Room	33 KV & 11 KV cable alley room	Fire; Earth Quake; Flood; Man Made Disaster	Open area between Switchyard & Main Gate

2. First Floor

SI No	Area	Occupier of room	Materials stored	Probable Hazards	Assembly Area
1	80 sq. Mtr.	Control Room	33 KV Panel : 2 Incoming + 3 outgoing + 1 BC		Open area between Control Room & Main Gate

			; 11 KV Panel : 2 Incoming + 4 outgoing + 1 BC, Tools; spares; Documents; Almirah; Chair ; Table	Fire; Earth Quake; Flood; Man Made Disaster	
--	--	--	-----------------------------------------------------------------------------------------------------------------------	------------------------------------------------------	--

3. Second Floor

SI No	Area	Occupier of room	Materials stored	Probable Hazards	Assembly Area
1	10 sq. mtr.	30 volt Battery Room	30 volt Battery Set 2 nos.	Fire; Earth Quake; Flood; Man Made Disaster	Open area between Control Room & Main Gate
2	30 sq. Mtr.	Control Room	33 KV C&R Panel , RTCC Panel, Batery Charger, ACDB, DCDB	Fire; Earth Quake; Flood; Man Made Disaster	
3	10 sq. Mtr.	Maintenance Room	Maintenance equipment	Fire; Earth Quake; Flood; Man Made Disaster	

There is no record of flood at the different 33/11 KV Sub-Station, so probable disaster of flooding has not been considered.

Fire Fighting Equipments

In respect of Fire hazards in different 33/11 KV sub-station the following Fire Fighting Equipments can be used to deal with the crisis situation.

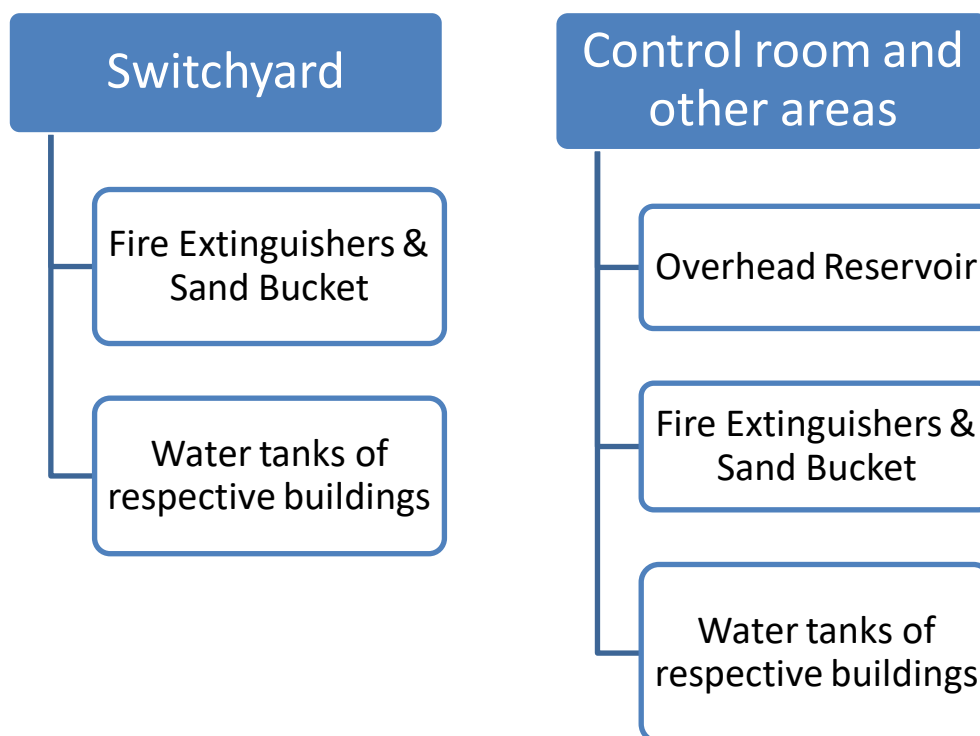

Fire Extinguishers

All 33/11 KV substation has sufficient number of fire extinguishers of all types i.e. A; B & C type located in major locations to deal with fire hazards. The Fire extinguishers are being regularly refilled. A details schematic diagram showcasing the location of fire extinguishers is displayed in control room building so that all the employees are aware of their locations and can readily use them in case of emergency. Apart from that, sand buckets are also maintained in the premises of the substation for use in case of fire exigencies. The detailed list of fire extinguishers is as follows:-

SI No	Type of Extinguisher	Number	Location
1	Co ₂ ; 3 kg	1	Control Room Battery Charger room
2	Co ₂ ; 4.5 kg	1	
3	Dry Chemical Powder; 5 Kg	2	
4	Water Type; 9 Liter	1	
5	Mechanical foam	1	
6	Fire Bucket	4	

Water Storage Capacity

The premises of the substation have water storage of sufficient quantity which may be used for extinguishing and dealing with fire exigencies. The detailed capacity of water storage is as follows:-

SI No	Water Storage	Location	Capacity
1	Overhead Reservoir	Roof of Control room	500 litres

Illumination

To protect the substation premises from manmade disaster and to deal with any form of natural disaster at night illumination plays a major role. Keeping that in view for switchyard high pressure mercury vapour lamps/ metal halide lamps are used and for the control room, and other areas fluorescent & energy saving lamps are used at different 33/11 KV sub-station.

Electrical Safety Measures

The following are used as electrical safety measures:-

- Insulated mats
- Hand gloves
- Safety Shoes
- Discharge rods
- Personal Protective Equipments like Safety belts, Safety helmets, Torch lights and safety ladder.

Entry Exit of Buildings

The control room building has two numbers of entry and exit which can be used simultaneously.

Available Manpower

The details of the available manpower at each 33/11 KV substation are as follows: -

Manpower Details			
Operation Staff : 7 nos.	Maintenance Staff (with vehicle driver): 12 nos.	Part time worker : 2	Security Guard : 4 nos.

A total number of 25 employees (working in different shift) both Departmental & outsourced posted at each 33/11 KV substation have been trained in First aid. First Aid

boxes, ready with all needful items, are maintained at Control room, Maintenance room and Security posts to enable immediate first aid treatment. Moreover, the detailed first aid treatment chart is displayed within control room building for further guidance of the employees in case of emergencies.

Communication System

Communication plays an important part in case of any natural and manmade disaster. In view of this, apart from BSNL landline and mobile connections, at each 33/11 KV substation, are maintained as important communication channels.

Security & Checking

In the interest of Safety and security, it is necessary that special precaution should be taken to prevent the entry of unauthorized persons into the premises of Mothabari 33 KV substation. The security personnel having army and paramilitary background regularly checks the entry and exit of persons and vehicles. One Supervisor (security) has also been posted at Mothabari 33 KV substation to oversee the security aspects of the premises. Moreover, proposal for declaring Mothabari 33 KV substation as "Protected Place" has also been forwarded to the authority to strengthen the security of the premises. The detailed shift wise deployment of security personnel in the premises is as follows: -

	Location	Morning	Evening	Night
Guards	Main Gate	1	1	2
Supervisor	General Shift (rounds)	0		

(B) Outside Building

Hospitals

The nearest hospitals in each 33/11 KV s/s has been displayed in the control room.

Fire Stations

The nearest fire stations and their contact numbers has been displayed in each 33/11 KV Sub-Station control room.

Ambulance Service

The nearest Ambulance Service and their contact numbers has been displayed in each 33/11 KV Sub-Station control room.

District Civil Administration Authority

The contact details of the concerned civil administration authority has been displayed in each 33/11 KV sub-Station.

Chapter 8 – Likely Perceived Scenario

Natural or manmade disaster in large scale can led to massive in the form of total destruction of building and adjacent areas and loss of major installation of the switchyard.

Chapter 9 – Suggested Response

The response in case of any kind of natural or manmade disaster is as follows:-

Chapter 10- Roles & Responsibilities

The area wise roles and responsibility of officers in case of any disaster is as follows:-

SI No	Area of Disaster	Period of Time	Incident Commander
1	Inside Control Room	Day & Night	Operator On Duty
2	Switchyard	Day & Night	
3	Staff Quarter & Allied Area	Day	Supervisor (Security)

Chaper 11 – Conduct of Mock Exercise

Safety Training

A safety Training was conducted in all 33/11 KV substation to make everyone conversant with safety regulations and processes. Regular monthly Safety Committee meetings are held at Mothabari 33 KV substation as per norms.

Mock Drill- Fire

Mock drills for fire are being regularly held at Mothabari 33 KV substation. All the operation, Maintenance, security personnel and staff of other department are involved in these trainings so that the Fire Extinguishers can be effectively used in case of any emergency.

First Aid Training

The personnel posted at different 33/11 KV substation have been trained to provide the necessary First Aid to the affected in case of emergency. A total number of 25 employees both departmental & outsourced posted at different 33/11 KV substation have been trained in First Aid.

Chapter 12 – Point of Contact

Official contact no of different sub-stations are as follows :

SI	Name of 33/11 kV Sub-Station	Contact No of Sub-Station	Blocks to Which Supplies Power
1	Rabindrabhaban	7449302668	English Bazar
2	Habibpur	7449302675	Habibpur
3	Kalindi	7449302667	English Bazar
4	Manikchak	7449302676	Manikchak
5	Narayanpur	7449302670	Old Malda
6	Kaliachak	7449302673	Kaliachak-I
7	Baishnabnagar	7449302674	Kaliachak-III
8	English Bazar	7449302669	English Bazar
9	Mothabari	7449302672	Kaliachak-II
10	Sujapur	7449302671	Kaliachak-I
11	Mobarakpur	8327095785	Old Malda
12	Milky	8927298862	English Bazar
13	Golapganj	9734682612	Kaliachak-III
14	Balia	8597055703	Old Malda

Contact no Officials for communication to be done by District Administration in case of Disaster

SI	Name of Blocks	Official Contact Points		
		Name	Designation	Contact No
1	English Bazar	Anirban Saha	Divisional Manager	7449302650
2	Habibpur	Rajesh Kumar	Assistant Manager(HR&A)	7449302651
3	Manikchak	Ganesh Chowdhury	Assistant Engineer(E)	7449302654
4	Old Malda	Imtiaz Ahammad	Assistant Engineer(E)	7449302655
5	Kaliachak-I			
6	Kaliachak-III			
7	Kaliachak-II			
8	Old Malda			

Chapter 12 – Disaster in 11 kV Line. 33 kV Line& LT line

In case due to disaster, any hazard such as breaking pole, conductor snapping etc. happens, requisite Poles are stacked in outside of Sub-Station & other materials are issued from Divisional Store at Nimaisarai. Also, there are more than 40 agencies working at under South Malda Division as well as different CCCs and each agency had approx. 12 nos manpower in their firm. In case any hazard, LOI will be issued to agencies considering the work involved and the agencies will take up the restoration work by utilizing the iron materials issued from Divisional Store and the poles from nearby Sub-Stations.

GOVERNMENT OF WEST BENGAL
IRRIGATION & WATERWAYS DIRECTORATE
OFFICE OF THE EXECUTIVE ENGINEER
MALDA IRRIGATION DIVISION
GREEN PARK, MALDA
P.O. - Mokdumpur
PIN-732103

Trigger Mechanism of Executive Engineer, Malda Irrigation Division

Sl. No	Name with Designation	Address	Responsibility	Telephone No	Mobile No
1	Sri. P.K. Samanta (Executive Engineer) M.I.D	Green Park, Malda	Flood forecasting officer	03512- 252395	9474737536
2	Sri. Subhadeep Dutta (AE/SDO) Malda Irrigation Sub-Division	Green Park Malda	Embankment, str. Under English Bazar, Gazole& old Malda block & Flood forecasting cell.		6297462512/ 9832673136
3	Sri. Sujoy Roy (AE/SDO) Malda Investigation. Sub-Division	Green Park Malda	Embankment, str. Under Habibpur&BamongolaRatua- II block (part).		7908538496
4	Sri. Asutosh Dutta (AE/SDO) Ganga Anti Erosion Sub-Division No-I	Green Park Malda	Embankment, str. Under Kaliachak I,II&III block.		9434656910
5	Sri. Asim Kumar Roy (AE/SDO) Ganga Anti Erosion Sub-Division No-II	Green Park Malda	Embankment, str. Under Manikchak, English Bazar(Ganga face) block.		9002555755/ 6295612385

Other important Contact No-

- 1) Flood forecasting Cell:- 03512-253939
- 2) Executive Engineer, MID(Office):- 03512-252395
- 3) Executive Engineer, MID(Residence) :- 03512-252278
- 4) Executive Engineer, MID (FAX):- 03512-254350
- 5) Superintending Engineer, North Irrigation Circle-I:- 03512-258036
- 6) MahanandaBhawan:- 03512-260480
- 7) Mahananda Embankment Division:- 03512-252598

Email-maldairrigation@gmail.com

Materials ready for flood fighting at beginning

Polythene bag:-25,000 Nos

Nylon crate: - 2000 Nos

Sand:- 7000 cft.

2) Arrangement for early warning message:

Flood fore casting cell is proposed to be functioning on & from **1st June 2020** in the office premises of Executive Engineer, Malda Irrigation Division.

River gauge & rainfall in catchment is collected daily for flood fore casting.

(a) River Ganga: River gauge from Allahabad to Farakka is collected through Central Water Commission, one Gauge at Manikchakghat is maintained by I& WD (Malda Irrigation Division).

(b)Tributary of Ganga in upper catchment: River gauge and rain fall of catchment area of Sone, Gandak, BurhiGandak, Koshi is also collected through CWC.

(c) River Mahananda: River gauge is collected from upper catchment i.c. Siliguri, Dengraghat&Jhawa through CWC one gauge at English Bazar, Malda is maintained by I& WD (Malda Irrigation Division)

(d) Fulahar: One gauge at Teljana (Harishchandrapur, Malda) is maintained by I& WD (Malda Irrigation Division)

Levels of gauge on different rivers

	River	Gauge Station	Danger level	Extreme Danger level
1	Ganga	Manikchakghat	24.69m	25.30m
2	Fulahar	Teljana	27.43m	28.35m
3	Mahananda	EnglishBazar	21.00m	21.75m

All the 39nos sluices are kept on close vigil & made operational before monsoon.

A number of works under Core State Plan and SDRF are taken up in the vulnerable location and likely to be completed before ensuing monsoon(List Attached) and Attempt is being made to upkeep the flood protection embankment with the available fund.

SL No	Name of Work	Remarks
1	Bank protection work to the left bank of river Mahananda for a length of 450M near Alinagar High School to the house of KhurshidAlam at Uttar Alinagar, Mouza-Alinagar in Block & P.S- Gazole, Dist- Malda.	50% physical progress
2	Bank protection and Beautification work to the L/B of river Mahananda for a length of 160.00m rear side of VVIP BUNGLOW at MahanandaBhawan in Block- Old Malda, P.S &Dist- Malda.	After resolving land issue work will be started
3	Reconstruction of Kalinagar Sluice Two vented situated over Kuriadaha Circuit Embankment in Block &P.S Gazole , Dist- Malda.	After resolving land issue work will be started
4	Construction of Two vented sluice over a cannel link with river Ganga to Sovapur Bill at Parshibpur, Pardaoana-Sovapur GP in Block-Kaliachak-III, P.S- Baishnabnagar, Dist- Malda	After recession of water level work will be started
5	Construction of Two vented sluice in place of wornout open culvert over MashaldighiMariakundu Circuit Embankment near ch.1.5Km in Block & P.S- Gazole. Dist -Malda.	After resolving land issue work will be started

6	Construction of 7- Vented Sluice Cum Bridge of carriage width of 4.25M at Chotopathari over Ashuni channel in Block & P.S Bamongola, Dist-Malda	Under tender Process
7	Bank protection work to the right bank of river Tangon for a length of 1000M from Mohammadpur primary school to house of Ananda Mohan Biswas at mouza-Emamnagar, G.P-Salaidanga in Block & P.S. Gazole, Dist-Malda.	Under tender Process
8	Bank protection work to the left bank of River Ganga at Sukurullahapur adjoining to Dwarf Bundh in G.P Bangitola for a length of 100M in Block-Kaliachak-II, Dist-Malda	Under tender Process
9	Bank protection work to the left bank of river Ganga at Bagedantola for a length of 575M in Block Manikchak, P.S- Bhutni, Dist; Malda	Under tender Process
10	Bank Protection work to the left bank of river Ganga at Nilkantatola for a length of 500M in Block-Manikchak, P.S-Bhutni, Dist- Malda	Under tender Process
11	Bank protection work of river Kalindri for alngth of 650M from Kalindri-Palpara more to Bengal Chak 2 nd culvert at Kalindri in Block & P.S Manikchak, dist Malda under Malda Irrigation Division.”	SDRF Under tender Process

Note- WAPCOS has been engaged to formulate a comprehensive flood management project to-

- Identification of the causes of flood.
- Assessment of present structural condition.
- Identification of critical vulnerable component.
- Identification/ Suggesting new structural intervention.
- Minimization of flood losses.

Final DPR already submitted by WAPCOS which includes number of bank protection works , strengthening of embankments, Construction of Sluice, de-siltation of drainage channel etc. and will be executed in the coming three years phase wise and priority basis.

Major river Channels	Name of Mouza likely to be inundated	Name of Gram Panchayata likely to be inundated	Population likely to be affected (Approx)	Nos & nature of hutments (Permanent & Temporary) of Huts (Approx)	Name of Blocks	Approx area likely to be inundated (Sq. Km.)	Remarks
1	2	5	3	4	6		7
Ganga	Bangitola,	Bangitola,	170	10(P) & 30(T)	Kalia chak II	0.26	Spill Zone
	Panchanandapur-I	Panchanandapur-I,	650	31(P) & 98(T)		0.48	
	Panchanandapur-II	Panchanandapur-II,	430	15 (P) & 71(T)		2.70	
	Hamidpur	Hamidpur	360	6 (P) & 70 (T)		3.60	
	Manikchak,Narayanpur, ugritola,	Manikchak	1000	300(T)	Manikchak	2.52	
	Dharampur,Khanpur	Dharampur	185	65		2.09	
	Jotbhabani, Khanpur	Gopalpur	1421	653		7.00	
	Mahadevpur-II,Jotkasturi	Bangitola	130	40	English Bazar	0.15	
Fulahar	Najirpur	Najirpur			Manikchak	3.00	Spill Zone
	Matharapur,Talimnagar	Matharapur				1.30	
Koshi	Kesharpur	Uttar Chandipur				2.20	
Mahananda	Sahapur	Sahapur	200	50(T)	Old Malda	0.10	
	Mahishbatani	Mahishbatani	1000	300(T)		1.80	
	Adampur	Muchia	400	80(T)		0.50	
	Kaliabad	Bargachia-I	700	160(T)		0.90	
Tangon	Muchia (Charlaxmipur)	Muchia	850	200(T)	Gazole	1.90	
	DobaKhokshan	Chaknagar	1000	220(T)		2.10	
	Emamnagar (Mahadevpur)	Salaidanga	1300	50(P) & 300(T)		2.80	
	Pathardighi	Mangalpur	700	15(P) & 150(T)	Habibpur	1.50	
	Aiho	Aiho	240	10(P) & 60(T)		0.50	
	Bulbulchandi	Bulbulchandi	250	10(P) & 50 (T)		0.50	
	AihoDanga	Aktail	1600	45(P) 7 275(T)		3.5	
	PatharJugi	Baidyapur	1300	40(P) & 250(T)		3.0	
Srimati	Mahakalbona	Alal	650	180(T)	Gazole	1.30	
Mahananda	Alinagar	Bargachia-I	800	50(P) & 150(T)		0.675	
Kalindri	Nimaisarai	Kotwali	330	20(P) & 60(T)	Englis a bazar	0.36	
Mahananda	Englisa bazar	Englisa bazar	1200	250(T)		0.30	
Punarbhaba	Laxminarayanpur,Nawabganj	Madnabati	6000	60(P) & 250(T)	Bamongola	10.0	
	NandinaDaha	Gobindapur-Mahashpur	5800	50(P) & 300(T)		10.0	
	Bamangram	Bamongola	1800	15(P) & 80(T)		3.0	
	Tilason	Dhumpur	1000	15(P) & 150(T)	Habibpur	2.0	
Haria	khutadaha	Chandpur	3500	25(P) & 150 (T)	Bamongola	6.0	

Details of Spill zone Landsubjected to inundation during moderate floodDetails of Char Land subjected to inundation during moderate flood

Major river Channels	Name of Mouza likely to be inundated	Name of Gram Panchayata likely to be inundated	Population likely to be affected (Approx)	Nos & nature of hutments (Permanent & Temporary) of Huts (Approx)	Name of Blocks	Approx area likely to be inundated (Sq. Km.)	Remarks
1	2	5	3	4	6		7
Ganga	Palashgachi, K.B. Jhowbona, Dari Diara, Birodhi, Ishlampur, Rajjakpur, Nittyandapur, Jitnagar, Parapur, Ratanpur, Mangalpur, Pearpur	Panchanandapur-I, (Suvantola char)	160	85(T)	Kaliachak -II	20.20	Charland
	Hamidpur, Dari joyrampur, Das Kathia	Hamidpur (Khatia K hana Char)	2150	480 (T)		6.20	
	Gobindapur, Raniganj, Rahimpur, Manikchak, Narayanpur	Manikchak (Narayanpur)	950	302(T)	Manikchak	3.5	

Vulnerable location under Malda Irrigation Division

River	Vulnerable location	Approx. Cost in Lakh	Length in 'M'	Remarks
Ganga	Bank protection & Embankment strengthening of Sokrullahpur Dwarf Embankment for a length of 2500M at Bangitola G.P in Block-Kaliachak-II, Dist-Malda.	2500	2500	110m already taken up & 350m proposed for 2020-21 Phase-I, , remaining expected in next phase depending on the availability of fund.
	Bank protection work to the left bank of river Ganga for a length of 2000M at Arjunpur ghat to Golapmondalpara, Pardewanpur- Sovapur, G.P, Block Kaliachak-III, Dist-Malda.	2000	2000	600m proposed in 2020-21 phase-I, remaining will be taken up part by part in next phase depending on the availability of fund.
	Bank protection work to the left bank of river Ganga from 15.600Km to 15.850Km and 16.150Km to 16.500Km of Bhutni Diara Circuit Embankment, near Mala Singh house in P.S –Bhutni, Block Manikchak, Dist-Malda.	980	600	440m proposed for 2020-21 Phase-I, remaining remaining will be taken up part by part in next phase depending on the availability of fund.
	“Bank protection work to the Left bank of river Ganga for a length of 150m at Narayanpur near upstream of Manikchak Ferry Ghat in P.S & Block- Manikchak, Dist.-Malda”	187.56	150	Proposed for 2020-21 Phase-I.
Fulhar	Bank protection work and restoration of embankment near mathurapur bhutni bridge in the u/s of sankoritola ferry ghat	900	1500	240 m length proposed for 2020-21 Phase-I, remaining remaining will be taken up

	for a length of 1500m block -Manikchak,			part by part in next phase depending on the availability of fund.
Punarbhaba	Bank protection work to the right bank of river Punarbhaba at Kupadaha adjacent of Nababnagar K.K.J.K. vidyapit for a length of 800 M. in Block & P.S Bamongola District-Malda.	316.3	800	remaining remaining will be taken up part by part in next phase depending on the availability of fund.

Tangon	Bank protection work on L/B of river Tangon at Baherpur near PHE for a length of 1000m at P.S. & Block-Bamongola Dist-Malda	350	1000	Estimate submitted , expected to be executed onpriority basis after availability of fund.
	Restoration of bank slope for a length of 130m in cluding construction of drain of river Tangon near residence of Ajit Das & Sanatan Ch. Laha at Baruipara in G.P-Aiho, Block & P.S Habibpur, District Malda	103.22	130	Proposed for 2020-21 Phase-I.
	Piralutala , GP - Chaknagar , Mouza - Dobakhoksan , Block-Gazole	250	500	Estimate submitted , expected to be executed on priority basis after availability of fund.
	Sisha-piralutola, GP - Chaknagar , Mouza - Dobakhoksan Block-Gazole	400	800	Estimate submitted , expected to be executed on priority basis after availability of fund.
Mahananda	Dewani , GP - Bairgachhi -II , Mouza - Saharole Block-Gazole	410	600	Estimate submitted , expected to be executed on priority basis after availability of fund.
	Rajaramchak, GP- Alal, mouza- Rajaramchak Block-Gazole	390	600	Estimate submitted , expected to be executed on priority basis after availability of fund.
	Gohula Danra, GP- Mahishbatani, Old Malda	45	160	Estimate submitted , expected to be executed on priority basis after availability of fund.
Ganga	Bank protection work to the left bank of river Ganga for a length of 650M at Rameshtola, in Ps bhutni, Block Mankchak.	840	650	Expected to be considered in 20-21Phase-II depending on the availability of fund
Koshi& Fulhar	Srengthening of Embankment including construction of Bituminus road on BDC embankment to the r/b of river Koshi and Fulhar from 17km to 27.5km in PS bhutni, Block Manikchak.	990	9500	Expected to be considered in 20-21Phase-II depending on the availability of fund
Tangon	Bank protection work on L/B of river Tangon at Bamongola for a length of 1000m at	325	1000	Expected to be considered in 20-21Phase-II depending on the availability of fund

	Mouza Bamangram near Police Station at P.S. & Block-Bamongola, Dist-Malda			
rimati	Mahakalbona, GP- Alal, mouza-Mobarakpur, Block-Gazole	410	800	Expected to be considered in 20-21Phase-II depending on the availability of fund
Mahananda	Borkol tagging embankment.GP Satmara Block-Ratua-II	82	400	Expected to be considered in 20-21Phase-II depending on the availability of fund
Ganga	Embankment strengthening to the left bank of river Ganga for a length of 1100M at Balutola of Gopalpur & Dharampur G.P under Manikchak Block, Dist-Malda	500	1100	After demarkation of land & availing the land scheme will be submitted to the higher authority.
	Bank protection work to the left bank of river Ganga for a length of 2000M at Gopalpur & Dharampur G.P under Manikchak Block, Dist-Malda	2500	2000	Expected to be considered in 20-21Phase-II depending on the availability of fund
	Bank protection work to the left bank of river Ganga for a length of 500M at sahebatola in Bhutni P.S Block Manikchak	650	500	Expected to be considered in 20-21Phase-II depending on the availability of fund

CONTINGENCY PLAN : PHE, MALDA

Disaster Management Plan of PHE Dte.

If any Disaster situation arises in Malda District, drinking water logistics will be provided by PHE. One Mobile Treatment Unit (MTU) under Malda Mechanical Division is in ready condition at Daulatpur, P.H.E. Campus for facing emergency situation.

1) Pre Disaster:-

Always ready with available manpower, equipments & machineries to face the untoward situation in consultation with the District Administration.

2) During Disaster :-

Apart from the MTU which is placed at PHE campus under Malda Mechanical Division, there are also two nos additional MTU units are present in Uttar Dinajpur & Dakshin Dinajpur district. We can also bring these MTUs from these districts on emergency basis.

Salient features of MTU :-

- a) Production: - It can produce 3500-4000 nos pouches per hour. Meanwhile it can produce 50,000 nos drinking water pouches per day.
- b) Water pouch capacity: - 350 ml, 500 ml.
- c) Operation:- It mainly runs on Electricity. If Electricity lines are being damaged due to disaster, in that case it can run with the DG set. Generator is always attached with the MTU.
Generator Details:-
 - a) It consumes 4 – 5 Litre diesel per hour.
 - b) Generator Capacity – 20 HP
 - c) Diesel storage capacity – 20 Litre.
- d) Time required: - After getting the information, only travel time is required to place the MTU at that disaster affected location.

3) Post Disaster: -

We will ensure replacing / repairing the PWSS pipe line along with SSP if required under the situation. If flood like situation arises, disinfection of tube wells & PWSS will be done immediately after divergence of flood water.

[Signature]
07/01/2020
Assistant Engineer
Malda Sadar Sub-Division
P.H.Engineering Dte.
Government of west Bengal

[Signature] 07/01/20
Executive Engineer
Malda Division
P.H.E. Dte. Govt. of W.B.

CIVIL DEFENCE PLAN 2020-2021

INTRODUCTION

Main Objectives Responsibilities and Activities Civil Defence includes any measures, not amounting to actual combat, for affording protection to any person, property, place or thing in India or any part of the territory thereof against any hostile attack, whether from air, land sea or other places or for depriving any such attack of the whole or part of its effect, whether such measures are taken before, during or after the time of such attack or any measures taken for the purpose of disaster Management, before, during, at, or after any disaster.

Aims :

- a. To save life.
- b. To minimize damage to property .
- c. To maintain continuity of production.

Scope: Civil Defence is the defence of the people, by the people and for the people. It is not the defence by the military as some may understand. Civil Defence is the measures adopted by the civilian population, Government, Local self-bodies, voluntary agencies, NGOs etc. during the war to minimize the effect of enemy action on men and its armed force to win the war in battle fields. In fact the scope has touched such a magnitude that Civil Defence is regarded as the fourth arm besides, Army, Navy and Air Force.

The West Bengal Civil Defence Organisation covers the following 12(twelve) services:

1. Headquarter Service.
2. Communication Service.
3. Warden service.
4. Casualty Service.
5. Firefighting Service
6. Training Service.
7. Rescue Service
8. Depot and Transport Service.
9. Supply Service.
- 10 Salvage Service.
- 11 Welfare Service
- 12 Corpse disposal Service.

Civil Defence Organisation: The West Bengal Civil Defence organisation is headed by an IPS officer of Director General rank, it has four wings, Civil Defence, West Bengal Civil Emergency Force, Water Wing Civil Defence and Casualty Section. Every District has a Civil Defence corps and the District Magistrate is also Controller of Civil Defence for the district and every Sub-Divisional Officer is the Dy. Controller of Civil Defence for the Sub-division for Kolkata area, there is a separate controller of Civil Defence. For administrative purposes, Kolkata area is subdivided into three sub-areas Kolkata North, Kolkata Central and Kolkata South, each headed by a Dy. Controller of Civil Defence. West Bengal is one of the limited number of states having a Central Civil Defence Training Institute, located at 199, NSC Bose Road, Kolkata- 700040.

Water Wings Civil Defence Personnel:- As per order of Director of Civil Defence of West Bengal, every year Water Wings Civil Defence personnel posted in this District for Flood relief and rescue operational purpose, and they may be posted to the different flood prone block, i.e. Kaliachak-I, Kaliachak- II, Kaliachak- III, Manikchak, Ratua- I, Harischandrapur-I & they are rendering the service the local people and stay in this District July to October CD Volunteers engaged for the above purpose as no boats, OBMs and other accessories kept at Itahargotlu store. We may collect the boats and OBMs from ItaharGotlu, Uttar Dinajpur during emergency period. The Water Wing of Civil Defence assists in rescue and relief operations through use of speed boats ,floating aids and trained manpower and volunteers. West Bengal Civil Emergency Force attends to any emergency and disaster with Quick Response Teams, rescue equipment ,speed boats and trained manpower and volunteers. The entire state of West Bengal has been declared as Civil Defence area .Each district has a large number of Civil Defence Volunteers who work continuously in the community towards fulfilling the 12 services of Civil Defence. Each district has at least two Civil Defence Rescue vehicles, fully equipped with modern rescue equipment, to respond immediately to any emergency.

Multy Disciplinary Centres :West Bengal Civil Defence has two Multy Disciplinary Centres, at Siliguri and Asansol.

Rescue Centres : West Bengal Civil Defence has three Rescue Centres at Mohanpur (PaschimMedinipur), Pursura (Hooghly) and Basirhat(North 24 Pgs).

Training:- Apart from carrying out training and rehearse/demonstration of Civil Defence measures during peace time, Civil Defence volunteers are also deployed, on a voluntary basis, in various constructive and nation building activities, which include providing assistance to the administration in undertaking social and welfare services and in the prevention/mitigation of natural/manmade disasters as well as in post disaster response and relief operations.As per order of Joint Secretary Department of Civil Defence has decided that all District and Sub- Divisional establishment shall arrange Different types of imparted types of Training for 5 (five) days , at least 8 (eight) batches per year comprising of 30 (thirty) volunteers per batch. And also be taken impart training club and other organization is under go sub Civil Defence Training like Basic C.D, First Aid, Fire Fighter, Disaster etc. The local people participated in the different types of training.

Camp:- As per order of District Magistrate & Controller of Civil Defence Malda, we may arrange yearly 1 (one) Camp in this District at different school for Disaster Camp, and the students attend the said training course.

Volunteers Service:- 100(one hundred) Civil Defence regular volunteers (boys & girls) are attend weekly parade every Sunday we are organize different types of training as per order of Civil Defence department and apart from that we are rendering service during flood relief, immersion, election, enforcement checking, crowd control, traffic duty, as and when District Administrative desires at in work.

Following are some of the major activities of West Bengal Civil Defence:

1. Monsoon deployment in flood prone districts.
2. Ganga SagarMela deployment.
3. Deployment during major festivals and celebrations.
4. Deployment for emergencies and Disaster.
5. Mock Exercises for emergencies and Disaster.
6. Relief, Rescue and First Aid.
7. Disaster and Emergency monitoring.

CIVIL DEFENCE OFFICE SETUP IN THIS DISTRICT

Sl no	Name of Post	Group	Sanction Strength	Man- In- Position	Vacant Posts
1	Sr, S.O.I	'A'	03	NIL	03
2	S.O.I	'B'	04	NIL	04
3	UDC	'B'	02	NIL	02
4	LDC	'C'	02	NIL	02
5	LDC cum Store Keeper Gr-II	'C'	02	01	01
6	Typist	'C'	01	01	NIL
7	Driver	'C'	02	NIL	02
8	Khalasi	'D'	01	01	NIL
9	D/rider	'D'	04	01	NIL
10	Peon	'D'	01	NIL	04
11	Night Guard	'D'	01	NIL	01
			Total-23	Total-03	Total-19
Four nos. Contractual Staff posted at Disaster Management & Civil Defence Section.					

Q.R.T:-

LIST OF MODERN EQUIPMENTS

Sl no	Name of the Equipments	No. of units
1	ID Jacket	50
2	Safety Helmet with chain strap with LED head lamp	5
3	Safety Helmet	50
4	Heavy duty working gloves	15 pairs
5	Safety nets	1
6	10 ton Hydraulic Jacket	1
7	36 ft Aluminium Ladder	2
8	Circular Saw with 350 mm cutting blade	2
9	Bullet Chain Saw 20 cutting blade	1
10	Life Jacket	5
11	Semi Static Kernamantle Rope 105mm dia	2
12	Fibre Rescue Stretcher with belts	1
13	Harness chair for vertical ascent & descent	2
14	Rope Delivery Gun	1
15	Generator 2800 wait	1
16	Seat Hurness	2
17	Power Ascender Battery operated	1
18	Fire Axe	4
19	Crow Bar 5 ft	4
20	Spade 5 ft	5
21	Shovel 10 handle	5
22	Sledge Hammer	2
23	Telescopic stand with Halogen light	2
24	Safety Helmet with Chain Strap with Visor	5
25	Chain filling kit	1
26	Screw Carabiner	8

27	Quick Draw	8
28	Mitt on Gloves	6 pairs
29	Tape sling 150cm	4
30	Manual Ascender new left	2
31	Stop lock descending	2
32	GriGri Manual	2
33	Tandem Fulley	2
34	Fixed pulley	3
35	Come Along	1
36	Blanket Wollen	5
37	First Aid Box with STD kit	1
38	Canvas Stretchere	3
39	Search light 500 mtr	3
40	Disposable mask	40
41	Rotary Hammer Drill	4
42	BA set with Carbon Composite Cylinder	4
43	Compressor Machine for Cylinder	1
44	Mega Phone	2

List of Civil Defence trained volunteersEnglish Bazar Block

Sl no	Name	Fathers Name & Address	Qualification	Mobile No
1	BapiMomin	BarikMomin, Vill + P.O- Amrity	B.A	9851798554
2	KabirMomin	MatinMomin, Vill + P.O- Amrity	H.S	7797989920
3	SubratoMandol	MonoharMandal, Piyasbari, Gour	H.S	8001178170
4	AtiulMomin	BarekMomin, Vill- Madia	H.S	8967948781
5	Kamal Poddar	MontuPoddar, Vill-Sova Nagar	M.P	6294169010
6	Abhijit Pal	Lt- NaruGopal Pal, Abhirampur	H.S	9733030472
7	BijoyProsad	Bachalalprosad, Rothbari	B.A	9614399550
8	Amit Dutta	Asit Dutta, Vill- Madhab Nagar,	M.A	8653749743
9	Tulsi Kr Saha	Lt- SoudagarSaha, Buraburitola	B.A	9775466406
10	ChiranjitKarmakar	SatyaKarmakar, Sovanagar	M.P	8759054002
11	Sorojit Ghosh	Sourindra Mohan Ghosh, Sovanagar	H.S	8906088048
12	MD SetaulHoque	MD Hossain Ali, Jadupur	B.A	9733299357
12	MD Babor Ali	Abdul Malek, Chandipur	H.S	8759803150
13	Sanjay Keshri	BachchalalProsadKeshri, Rothbari	B.A	9547833012

Old Malda

Sl no	Name	Fathers Name & Address	Qualification	Mobile
1	DebasishMandal	DharaniMandal, Sahapur	B.A	7584973503
2	Dwip das	Jagodish Das, Sahapur	H.S	8759662522
3	SatyajitSatiar	BakulSatiar, Sahapur	H.S	9679651251
4	Kartik Sarkar	Naren Sarkar, Nageswarpur	B.A	8768847959
5	Prasad Chowdhury	Narayan Chowdhury, Nageswarpur	B.A	9734121090
6	Amit Karmakar	DilipKarmakar, Chhatiyamore	B.A	8759306086
7	Anirban Roy Chowdhury	Kalki Narayan Chowdhury	H.S	7031329655

Kaliachak-I

Sl no	Name	Fathers Name & Address	Qualification	Mobile
1	ProsenjitSaha	HariCharanSaha, Najirpur	H.S	8145126477
2	MD SenaulMandal	ChhotoSujapur	H.S	9851454288
3	AlaminSeikh	MD Zulfikar Ali, Jalalpur	M.P	8001791718
4	MD Mursalim	MD EsawHoque, Bamongram	M.A	9614040016
5	Obaidullah	Niaz Ahmed, Uttar Dariapur	M.P	8642080450

Ratua-I

Sl No	Name	Fathers Name & Address	Qualification	Mobile
1	EjajulHoque	FajlulHoque, Bilaimari, P.S-Ratua	B.A	9083217825
2	MD Kamruddin	Entaj Ali, Vill + P.O-Chandmoni,	M.A	9593862184
3	MD Golam Ahmed	Safiqul Islam, Chandmoni	M.A	9647776645
4	Selim Akhter	Mojahar Ali, Vill- Harikol, P.O- Chandmoni	M.A	9647675919
5	Bapan Kr Singha	Ashoke Kr Singha, Vill+P.O-Debipur	M.P	8145709244
6	RanjanMandal	ChaitanyaMandal, Vill- Bairia	B.A	9800087287
7	Ganesh Singha	RatanSingha, Debipur	M.P	9830916822
8	MeghdutPramanik	Nanda LalPramanik, Debipur	H.S	9733379688
9	SumonSingha	Manoj Kr Singha, Debipur	H.S	7602060941
10	PijushKantiSingha	Late Pradip Kr Singha, Debipur	H.S	7584039705
11	PalashPramanik	DijendraNathPramanik, Debipur	H.S	7602335249
12	SK Matin	SK Sakimuddin, Debipur	M.P	7797991387
13	JalimSabjee	RasulSabjee	H.S	9733705147

Ratua-II

Sl No	Name	Fathers name & Address	Qualification	Mobile
1	SK Anwar Hossain	SK Harun Hossain, Araidanga	H.S	9749017915
2	SanjoyMajhi	NarenMajhi, Araidanga	H.S	7365898477
3	Bubai Ghosh	Ratan Ghosh, Vill + P.O-Pranpur	H.S	9609752280
4	Biswajit Roy	Shyamal Roy, Pukhuria	B.A	9775339596
5	AsimBarik	LakshmaiBarik, Vill + P.O-EkBarna	H.S	9609889144

Manikchak

Sl no	Name	Fathers Name & Address	Qualification	Mobile
1	Mithun Ghosh	Pratap Ghosh, Vill- Khanpur, Dharampur	H.S	7031861287
2	Fakir Ghosh	Prafulla Ghosh, Dharampur	M.P	8016633883
3	Malay Saha	SatishSaha, SalabatGanj, p.O-Chowki	H.S	9647810253
4	SK khusimuddin	SK Naful, Vill- Koritola	H.S	9734180398
5	Soumen Tanti	Dhirendranath Tanti, Raj Nagar	H.S	8967218768
6	AkterSabjee	AlauddinSabjee, Vill-SalabatGanj	M.P	9635018294
7	RajuMandal	HarendraNathMandal, Vill-Khanpur	M.P	9614605472
8	DipakSaha	SatishSaha, Vill- SalabatGanj	H.S	7718245777

Chanchal-I

Sl no	Name	Fathers Name & Address	Qualification	Mobile
1	JishuMandal	Lt- ShibapadaMandal,kaligram	B.A	9563433329
2	MD Ismail	LalMahammad, Vill- Malahar	M.P	9732402779
3	ChotonSaha	ParanSaha, Bhagabatipur	H.S	9126594929
4	Prasenjit Das	Prahalad Das, Chanchal	B.A	8348321414
5	Sagar Das	Shyamal Das, Kaligram	H.S	8101296954
6	MD Arafin	Abdul Majid, Kaligram	B.A	8967528945

Chanchal-II

Sl no	Name	Fathers Name & Address	Qualification	Mobile
1	Rony Biswas	Ranjit Biswas, Vill- Paharpur, Kalitola	H.S	9647038060
2	MintuSaha	ChittaranjanSaha, Vill-Paharpur	B.A	8906337968
3	KartikMandal	MadhuMandal, Paharpur	M.P	8145870997
4	ZiaurRahaman	MojammelHoque, Janipur	H.S	9593068126
5	DebasishSaha	NaruSaha, Vill- Paharpur	B.SC	9734530505

Habibpur

Sl no	Name	Fathers Name & Address	Qualification	Mobile
1	Abhijit Roy	Nepal Roy, Baxi Nagar	H.S	7098478140
2	Dipnkar Das	Pradip Das, Vill- MadhyamKendua	H.S	8918595314
3	ShibuMandal	ChaitanyaMandal, Vill- Uttaral	H.S	8906204458
4	Subhankar Das	Pradip Das, Vill- Madhyam Gram	M.A	9851822597
5	Dipankar Das	Pradip Das, MadhyamKendua	H.S	8918595314
6	Biplab Sarkar	Gajen Sarkar, kachupukur	H.S	9933394638
7	Pijush Mukherjee	Prabal Mukherjee, Bulbulchandi	B.A	9800015020
8	Bishal Ghosh	Sukumar Ghosh, Habibpur	H.S	9800575652
9	JayabrataKarmakar	Anil Karmakar, Vill- Chandpur	B.A	9933678107
10	IndranilSaha	SwapanSaha, Habibpur	H.S	9647784714

Harishchandrapur II

Sl no	Name	Fathers Name & Address	Qualification	Mobile
1	Santosh karmakar	BijoyKarmakar, Bhalukka Bazar	B.A	9733078980
2	Ashish Paswan	Rabi Paswan, H.C Pur	H.S	8670510415
3	Uttam Das	Parimal Das, H.C Pur	H.S	9733203905
4	Bapi Kumar Das	Patul Das, H.C Pur	B.A	9635101868
5	Rasedul Islam	Mir Riajuddin, Bhalukka Bazar	B.A	7585030786
6	Mrinal Roy	Bharat Roy, H.C Pur	M.P	6295891042
7	DipuMahaldar	HaripadaMahaldar, Belsur	M.A	8436851789
8	Raj Kumar Mahaldar	HaripadaMahaldar, H.C pur	H.S	7718282627
9	Sachin Kr Mandal	Sudhir Kr Mandal, H.C pur	H.S	7797853433

Harishchandrapur I

Sl no	Name	Fathers Name & Address	Qualification	Mobile
1	Chanchal Das	Haren Chandra das, Ramrai	M.P	9734646767
2	Sandeep Kr Das	Shyamal Kr Das, HCpur	M.P	9800669333
3	Bappa das	Shubal Das, HCpur	M.P	9851058188

Bamongola

Sl no	Name	Fathers Name & Address	Qualification	Mobile
1	SubhajitKarmakar	ChandniKarmakar, Vill:- Bangitola, P.S:- Bamongola, Dist:- Malda.	H.S	75518-23167
2.	ShyamPramanik	Late ChitoPromanik, Mohanpur	H.S	7718380778
3.	SumanMandal	JadavMandal	H.S	70313-83325

DISASTER MANAGEMENT PLAN 2020-2021

1. OFFICE ADDRESS: EXECUTIVE ENGINEER,
MALDA HIGHWAY DIVISION,
PUBLIC WORKS (ROADS) DIRECTORATE,
ROADS COMPLEX, SINGATALA, MALDA
P.O- MOKDUMPUR,
DIST.- MALDA, PIN-732102,
E-MAIL- malda.hwdn@gmail.com

2. HEADED BY: EXECUTIVE ENGINEER

MALDA HIGHWAY DIVISION, UNDER PUBLIC WORKS (ROADS) DIRECTORATE, IS INVOLVING IN THE WORKS OF DEVELOPEMENT AND MAINTENANCE OF STATE HIGHWAY, MDR, ODR AND VR IN THE DISTRICT OF MALDA.

- MALDA HIGHWAY DIVISION HAVE THREE SUB-DIVISIONS, NAMELY
 - i. MALDA HIGHWAY SUB - DIVISION, (OFFICE AT MALDA)
 - ii. CHANCHAL HIGHWAY SUB - DIVISION, (OFFICE AT CHANCHAL)
 - iii. GAZOLE HIGHWAY SUB - DIVISION, (OFFICE AT GAZOLE)
- DETAILS OF DIFFERENT ROADS ARE ENCLOSED AS UNDER:

List of Roads under Malda Highway Division, P.W. (Roads) Directorate					
SL NO.	Name of Road	Category	Length	Jurisdiction	Officer in-charge for maintenance
1	Baharal-Araidanga-Madiaghat Road	MDR	20.09	Malda	MHSD
2	Baishnabnagar to Jaldahi Road	MDR	4.80	Malda	MHSD
3	Jalalpur to Sujapur to Jamirghata Railway Station Road	ODR	2.10	Malda	MHSD
4	Kagmari to Bangitola to Panchanandapur Road	MDR	7.00	Malda	MHSD
5	Kaliachak to Golapganj Road	MDR	9.50	Malda	MHSD
6	Kaliachak to Niamatpur Road	MDR	20.40	Malda	MHSD
7	Kotwali Ferryghat to Pukuria Ferryghat Road	MDR	13.80	Malda	MHSD
8	Link road to Araidanga Health Centre	MDR	1.10	Malda	MHSD
9	Mathurapur to Sankoritola Road	ODR	1.65	Malda	MHSD
10	Pukuria to Goborjona Kalibari Road	ODR	3.40	Malda	MHSD
11	Sadullahpur Meharapur Road	MDR	10.08	Malda	MHSD
12	Mothabari to Sadullahpur	MDR	6.90	Malda	MHSD

13	Mothabari to Uttar Lakshipur Road	MDR	3.20	Malda	MHSD
14	Pagla Approach Road	MDR	6.00	Malda	MHSD
15	Englishbazar to Kotwali Road	MDR	8.20	Malda	MHSD
16	Approach Road to Madhabpurghat Bridge (Malda Side)	MDR	2.55	Chanchal	CHSD
17	Bhaluka Bazar to Bhaluka Road Railway Station Road	MDR	7.80	Chanchal	CHSD
18	Bhaluka Road Railway Station Road to Tulshihata Road	MDR	13.60	Chanchal	CHSD
19	Chanchal to Kharba to Churamonghat Road	MDR	11.20	Chanchal	CHSD
20	Feeder road from Tulshihata to Khushidha Road	VR	0.20	Chanchal	CHSD
21	Link road from CKC road to Koligram Village	VR	1.06	Chanchal	CHSD
22	Link road from Harishchandrapur to Bardwari Road	MDR	2.70	Chanchal	CHSD
23	Link road from Tulshihata to Khushida to Bishunupur High School.	VR	0.80	Chanchal	CHSD
24	Link road Harishchandrapur Health Centre	VR	1.58	Chanchal	CHSD
25	Link road to Bhaluka Health Centre from Ratua Bhaluka road	VR	0.80	Chanchal	CHSD
26	Link road to Vingol Health Centre from Chanchal Harishchandrapur Road	ODR	2.19	Chanchal	CHSD
27	NH-81 to Harishchandrapur Railway Station Road	MDR	2.60	Chanchal	CHSD
28	Paharpur Swarupganj Road	ODR	17.10	Chanchal	CHSD
29	Pukuria Ferryghat to Kumarganj Road	MDR	10.90	Chanchal	CHSD
30	Ratua Bhaluka Road	MDR	11.20	Chanchal	CHSD
31	Seikhpur to Kumarganj Road	MDR	4.70	Chanchal	CHSD
32	Tulshihata to Khushida Road	MDR	11.00	Chanchal	CHSD
33	Adina to Chakli Road	VR	33.62	Gazole	GHSD
34	Agampur to Raniganj Road	MDR	8.30	Gazole	GHSD
35	Alternative Route to Balurghat from Malda	MDR	3.80	Gazole	GHSD

36	Approach road Tagon Bridge	MDR	0.75	Gazole	GHSD
37	Bamongola to Habibpur Road (0.00 kmp to 6.00 kmp)	MDR	6.00	Gazole	GHSD
38	Bamongola to Habibpur Road (6.00 kmp to 21.28 km)	SH	15.28	Gazole	GHSD
39	Bulbulchandi to Habibpur Road	SH	7.20	Gazole	GHSD
40	Bubulchandi to Katlapukur Road	MDR	14.50	Gazole	GHSD
41	Eklakhi to Rashikpur Road	MDR	8.54	Gazole	GHSD
42	Gazole Beldangi Road	MDR	5.60	Gazole	GHSD
43	Gazole to Alalghat Road (except Kodubari to Samsi)	MDR	2.06	Gazole	GHSD
44	Gazole to Bamongola Road	MDR	16.00	Gazole	GHSD
45	Gazolehat Road	ODR	0.90	Gazole	GHSD
46	Internal communication road in Pandua	MDR	3.00	Gazole	GHSD
47	Link road to Habibpur Police Station	VR	0.35	Gazole	GHSD
48	Malda Bulbulchandi Road	SH	15.20	Gazole	GHSD
49	Mirzapur Banshihari Road (0.00 kmp to 22.09 kmp)	SH	22.09	Gazole	GHSD
50	Muchia to Singabad Road	ODR	8.31	Gazole	GHSD
51	NH 34 to Eklakhi Railway Station Road	ODR	8.90	Gazole	GHSD
52	Nimbari Harishchandrapur Road	MDR	7.00	Gazole	GHSD
53	Mahadipur bridge to Golapganj Police Phari Road	VR	8.68	Gazole	GHSD
54	Pubarun to Hussenpur Road from	VR	7.50	Gazole	GHSD
TOTAL LENGTH			423.78		

3. DETAILS OF PHONE NUMBERS OF OFFICERS UNDER THIS DIVISION:

SL NO.	NAME	DESIGNATION	MOBILE NO.
1	JAGANNATH SAMANTA	EXECUTIVE ENGINEER, MALDA HIGHWAY DIVISION, P.W. (ROADS) DIRECTORATE	9051755519
2	DIGANTA KUNDU	ASSISTANT ENGINEER, MALDA HIGHWAY SUB- DIVISIONP.W. (ROADS) DIRECTORATE	9474686006
3	TAPAS KUMAR SAHA	ASSISTANT ENGINEER, CHANCHAL HIGHWAY SUB- DIVISIONP.W. (ROADS) DIRECTORATE	6294645284
4	PIJUSHKANTI JANA	ASSISTANT ENGINEER, GAZOLE HIGHWAY SUB- DIVISIONP.W. (ROADS) DIRECTORATE	6292122511

CONTINGENCY PLAN ENGLISHBAZAR FIRE STATION**IMPORTANT CONTACT NUMBER**

Sl. No	Name of Staff	Designation	Contact Number
English Bazar Fire Station			
1	Sri Dewan Lapcha	Divisional Officer	9735070370
2	Sri Lakshman Chandra Karmakar	Station Officer	9153210232
3	Sri Biswajit Mandal	Sub-Officer	9609959712
4	Sri Dharani Kanta Paul	Sub Officer	9735010734
5	Sri Bilash Banik	Sub-Officer	9641872122
6	Control Room (24x7)	-	03512-278854
Chanchal Fire Station			
1	Sri Ratan Kumar Singh	Station Officer	9851038655
2	Sri Sukanta Biswas	Sub Officer	9734197275
3	Control Room (24x7)	-	03513252101/111
Harischandrapur Fire Station			
1	Sri Prabir Kumar Roy	Station Officer	9083287152
2	Sri Dhirendranath Saha	Sub-Officer	9593439087
3	Control Room (24x7)	-	03513-244121

